

St George

Use and Care Guide and Warranty Automatic Clothes Dryer

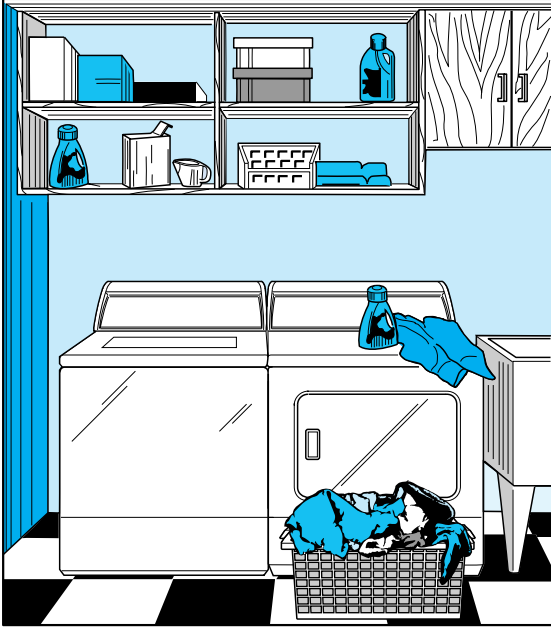

D310E3B

Full Five Year Warranty Parts & Labour



LEG37A*F4350
LGG37A*F3058



KEEP THESE INSTRUCTIONS FOR FUTURE REFERENCE. (If the dryer changes ownership, be sure this manual accompanies the dryer.)

Part No. 510906
August 1999

Table of Contents

Important Safety Instructions	3
Before Drying	5
Energy Saving Tips.....	5
Helps and Hints	5
Sort	6
Load.....	6
Operating Instructions	7
Drying Special Items	9
User-Maintenance	12
Care Of Your Dryer	12
Motor Overload Protector	12
Lint Filter	13
Before You Call For Service	14
If Service Is Required	15
Automatic Dryer Warranty	Inside Back Cover
Information For Handy Reference	Back Cover



WARNING

FOR YOUR SAFETY, the information in this manual must be followed to minimize the risk of fire or explosion or to prevent property damage, personal injury or death.

W033

- **Do not store or use gasoline or other flammable vapors and liquids in the vicinity of this or any other appliance.**
- **WHAT TO DO IF YOU SMELL GAS:**
 - **Do not try to light any appliance.**
 - **Do not touch any electrical switch; do not use any phone in your building.**
 - **Clear the room, building or area of all occupants.**
 - **Immediately call your gas supplier from a neighbor's phone. Follow the gas supplier's instructions.**
 - **If you cannot reach your gas supplier, call the fire department.**
- **Installation and service must be performed by a qualified installer, service agency or the gas supplier.**

W052

IMPORTANT SAFETY INSTRUCTIONS

(Save These Instructions)

	WARNING
<p>To reduce the risk of fire, electric shock, serious injury or death to persons when using your dryer, follow these basic precautions:</p>	
<small>W130</small>	

1. Read all instructions before using the dryer.
2. Refer to the **EARTHING INSTRUCTIONS** in the **INSTALLATION** manual for the proper earthing of the dryer.
3. Do not dry articles that have been previously cleaned in, soaked in, washed in, or spotted with gasoline, dry-cleaning solvents, other flammable or explosive substances as they give off vapors that could ignite or explode.
4. Do not allow children to play on or in the dryer. Close supervision of children is necessary when the dryer is used near children. This is a safety rule for all appliances.
5. Before the dryer is removed from service or discarded, remove the door to the drying compartment.
6. Do not reach into the dryer if the cylinder is revolving.
7. Do not install or store the dryer where it will be exposed to the water and/or weather.
8. Do not tamper with the controls.
9. Do not repair or replace any part of the dryer, or attempt any servicing unless specifically recommended in the **User-Maintenance Instructions** or in published user-repair instructions that you understand and have the skills to carry out.
10. Do not use fabric softeners or products to eliminate static unless recommended by the manufacturer of the fabric softener or product.
11. To reduce the risk of fire, **DO NOT DRY** plastics or articles containing foam rubber or similarly textured rubberlike materials.
12. Always clean the lint filter after every load. A layer of lint in the filter reduces drying efficiency and prolongs drying time.
13. Keep area around the exhaust opening and adjacent surrounding area free from the accumulation of lint, dust and dirt.
14. The interior of the dryer and the exhaust duct should be cleaned periodically by qualified service personnel.
15. This gas appliance contains or produces a chemical or chemicals which can cause death or serious illness and which are known to the State of California to cause cancer, birth defects, or other reproductive harm. To reduce the risk from substances in the fuel or from fuel combustion, make sure this appliance is installed, operated, and maintained according to the manufacturer's instructions.
16. Dryer will not operate with the loading door open. **DO NOT** by-pass the door safety switch by permitting the dryer to operate with the door open. The dryer will stop tumbling when the door is opened. Do not use the dryer if it does not stop tumbling when the door is opened or starts tumbling without pressing or turning the **START** mechanism. Remove the dryer from use and call the serviceman.
17. Do not put articles soiled with vegetable or cooking oil in the dryer, as these oils may not be removed during washing. Due to the remaining oil, the fabric may catch on fire by itself.

18. To reduce the risk of fire, **DO NOT** put clothes which have traces of any flammable substances such as machine oil, flammable chemicals, thinner, etc. or anything containing wax or chemicals such as in mops and cleaning cloths, or anything dry- cleaned at home with dry-cleaning solvent in the dryer.
19. Use the dryer only for its intended purpose, drying clothes.
20. Always disconnect the electrical power to the dryer before attempting service. Disconnect the power cord by grasping the plug, not the cord.
21. If the supply cord is damaged, it must be replaced by a special cord or assembly available from the manufacturer or its service agent.
22. Install this dryer according to the **INSTALLATION INSTRUCTIONS**. All connections for electrical power, earthing and gas supply must comply with local codes and be made by licensed personnel when required. Do not do it yourself unless you know how!
23. Remove laundry immediately after the dryer stops.
24. Always read and follow manufacturer's instructions on packages of laundry and cleaning aids. Heed all warnings or precautions. To reduce the risk of poisoning or chemical burns, keep them out of reach of children at all times (preferably in a locked cabinet).
25. Do not tumble fibreglass curtains and draperies unless the label says it can be done. If they are dried, wipe out the cylinder with a damp cloth to remove particles of fibreglass.
26. **ALWAYS** follow the fabric care instructions supplied by the garment manufacturer.
27. Never operate the dryer with any guards and/or panels removed.
28. **DO NOT** operate the dryer with missing or broken parts.
29. **DO NOT** by-pass any safety devices.
30. Failure to install, maintain, and/or operate this machine according to the manufacturer's instructions may result in conditions which can produce bodily injury and/or property damage.

NOTE: The WARNING AND IMPORTANT SAFETY INSTRUCTIONS appearing in this manual are not meant to cover all possible conditions and situations that may occur. Common sense, caution and care must be exercised when installing, maintaining, or operating the dryer.

Always contact your dealer, distributor, service agent or the manufacturer about any problems or conditions you do not understand.

Before Drying . . .

Energy Saving Tips

- Make sure the lint filter is always clean.
- Do not overload the dryer.
- Do not overdry items.
- Remove items to be ironed while still damp.
- Large loads of similar fabrics dry the most efficiently. However, dry permanent press in smaller loads to prevent wrinkling.
- Use the correct cycle for the type of fabric being dried.
- Locate your dryer so the exhaust duct is as short and straight as possible.
- Do not open the door during the drying cycle.
- Plan to do your laundry on low humidity days; your clothes will dry faster.
- Dry multiple loads of clothes one right after another so dryer interior does not have to be reheated for each load.

Helps and Hints

	WARNING
To reduce the risk of fire, explosion, serious injury or death, clothes which have traces of any flammable substances such as cooking oil, machine oil, flammable chemicals, thinner, etc. must not be put into the dryer.	
W131	

- The necessary suggestions and directions for installation and proper exhausting are given in the INSTALLATION INSTRUCTIONS which are included with the dryer.
- Static electricity may cause garments of synthetic fibres (as in lingerie) to cling together, especially if they are overdried. The use of a liquid fabric softener in the rinse water of the washer, or a fabric softener sheet in the dryer, will soften clothes and reduce static electricity.
- Do not wash or dry clothes that shed lint in the same load with permanent press or knit garments.
- Remove permanent press loads immediately after dryer stops.
- Follow the CARE LABELS on FLAME RETARDANT, SCOTCH- GUARD™, etc., garments for the proper washing and drying.
- If loads should be damp for ironing, turn timer knob to the ENERGY SAVER setting, marked with a dot (•), in Automatic or Time Dry cycles.

Sort

If you have correctly sorted the items for washing, they should be properly sorted for drying too.

Separate:

Lights

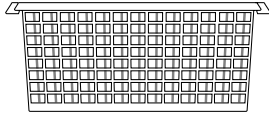

Darks

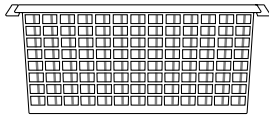

Separate:

**Lint Shedding
Fabric**

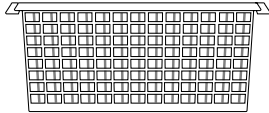

**Lint Receiving
Fabric**

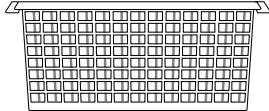

Separate:

No Heat Items

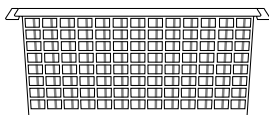

Low Heat Items

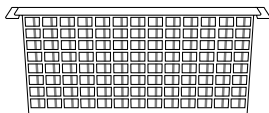

High Heat Items

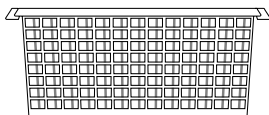

Towels, flannels, chenille, cottons, rugs, etc., shed lint. Corduroys, knits (including socks), permanent press, and synthetics attract lint.

In any kind of drying, lightweight fabrics will dry faster than heavyweight fabrics. If mixed loads are dried together (such as sheets and towels), remove the lighter weight fabrics when they are dry to prevent overdrying and wrinkling. The best method is to dry clothes which require the same time and temperature in the same load.

Load

Do not overload your dryer. Bulk, not weight, determines the load size. If the dryer is overloaded, it could cause discoloration or permanent heat damage to the load. There should be space in the dryer for the clothes to tumble freely. This helps to reduce wrinkles. Large and small pieces together make up loads which will tumble well. Permanent press loads should be smaller to provide room for tumbling. Proper tumbling allows for fewer wrinkles. The following illustrations show the ideal load sizes for fabrics. The average load will fill the cylinder one third to half full when wet.

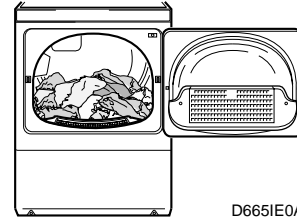

**Cylinder with wet
cottons and linens**

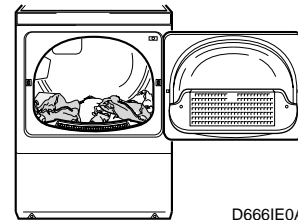

**Cylinder with wet
permanent press**

A load can be too small. Just a few small pieces will not tumble properly. They will take longer to dry and they may be wrinkled. For small loads, add a couple of large towels or non lint shedding items to aid in tumbling.

Operating Instructions . . .



WARNING

To reduce the risk of fire, electric shock, serious injury or death to persons, read the **IMPORTANT SAFETY INSTRUCTIONS** on pages 4–5 before operating the dryer.

W128-2

Available Drying Cycles

NOTE: Use the automatic cycles for drying items that can be dried with heat. These cycles automatically dry loads to the dryness level selected.

MORE DRY will dry very small loads and some heavy items, such as blue jeans, but will overdry lightweight items, such as sheets and shirts. Overdrying can cause wrinkling, shrinking, excessive lint conditions, and will use more energy than necessary.

LESS DRY, which uses the least energy, will dry large loads and lightweight items, such as sheets and shirts, but might leave other items, such as denim and heavy bath towels, more damp.

To increase energy savings and to make sure loads are dried without overdrying, set your loads on *LESS DRY*. If items are damp at the end of a cycle, the timer knob needs to be set closer to the *MORE DRY* setting the next time these loads are dried. If items are overdry at the end of a cycle, the timer knob should be set closer to *DELICATE* or *COOL TUMBLE* when these loads are dried again. Remember the settings that work best to get ideal drying results.

DELICATE, available only in the AUTOMATIC REGULAR/DELICATE cycle, will dry sheer items and very lightweight cottons, but will leave heavier items damp. If items are damp at the end of the cycle, set the timer knob closer to the *LESS DRY* setting the next time these loads are dried. If items are overdry at the end of the cycle, the timer knob should be set closer to *COOL DOWN*.

The *COOL DOWN* and *COOL TUMBLE* period at the end of each cycle provides items a chance to tumble with no heat and cool down to room temperature. This prevents wrinkles from setting if items cannot be cared for immediately.

NOTE: The timer knob will not advance as quickly in the AUTOMATIC cycles as it does in the TIME DRY cycle. The time it takes for the timer to advance depends on the type and size of the load being dried.

Automatic Regular/Delicate Cycle

Use for sturdy items like play or work clothes and also for delicate items. The type of heat is determined by choosing the proper **Fabric Selector** option. There are three settings in the AUTOMATIC REGULAR/DELICATE cycle—*MORE DRY*, *LESS DRY*, and *DELICATE*.

Time Dry Cycle

This cycle will operate dryer for up to 80 minutes. Cottons and heavyweight items dry best between 50 and 70 minutes, and lightweight items dry best between 20 and 40 minutes.

Automatic Permanent Press/Knits Cycle

Use for permanent press items and synthetics. The type of heat is determined by selecting the proper **Fabric Selector** option (see following page). There are two settings in the AUTOMATIC PERMANENT PRESS/KNITS cycle—*MORE DRY*, and *LESS DRY*.

To Dry Clothes

IMPORTANT: See the **INSTALLATION INSTRUCTIONS** before using dryer.

IMPORTANT: Before using dryer for the first time, use an all purpose cleaner, or a detergent and water solution, and a damp cloth to remove shipping dust from inside dryer drum.

1. Sort items into separate loads.



D305IE1A

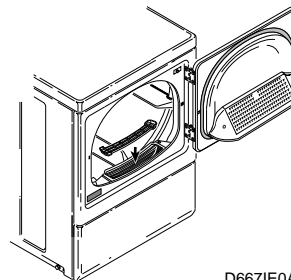

D667IE0A

2. Remove lint filter cover, clean lint filter and replace cover before each use.

3. Add clothes loosely into dryer drum. Add fabric softener sheet, if desired.

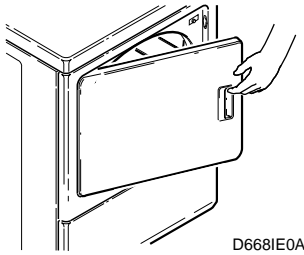
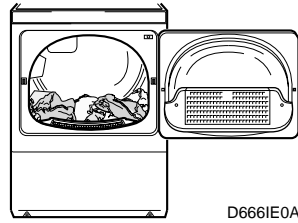

4. Close loading door. Dryer will not operate with the door open.

5. Select FABRIC SELECTOR. Follow garment manufacturer's care labels for recommended temperature settings.

FABRIC SELECTOR

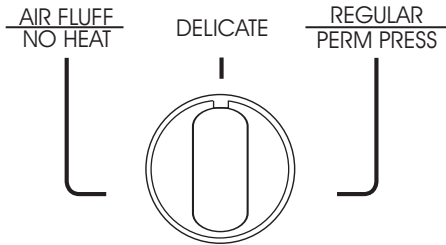

6. Select

timer setting in cycle desired: AUTOMATIC REGULAR/DELICATE, TIME DRY, and AUTOMATIC PERMANENT PRESS/KNITS. These cycles control the drying time.

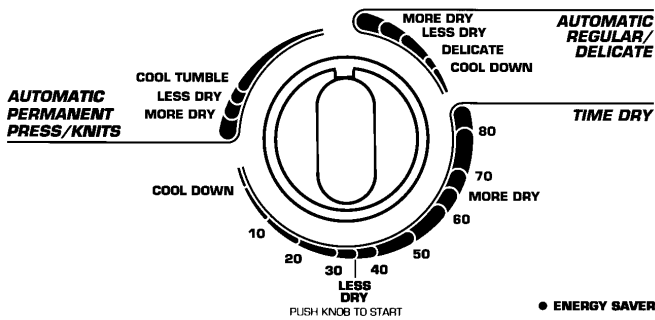

7. Push timer knob in to start dryer.

NOTE: To stop dryer at any time, open the door or turn timer knob to an OFF position. To restart dryer, close door, reset timer if necessary, and push in the timer knob.

End of Cycle Signal

The volume of the signal tone may be set on *OFF*, *LOUD* or between the two selections. If a volume level is selected, the signal will let you know when the cycle is done. The signal will stop when the door is opened, or when the timer is advanced to an OFF position.

SIGNAL

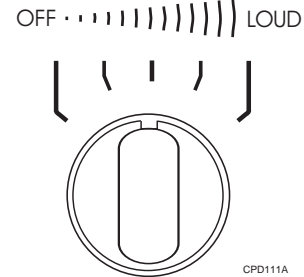

Drying Rack

The drying rack is useful for items that require no-tumble drying, such as tennis shoes, sweaters, stuffed toys or other delicate items.

The rack can be installed by inserting drying rack mounting into the two (2) round holes in door. See the illustration below.

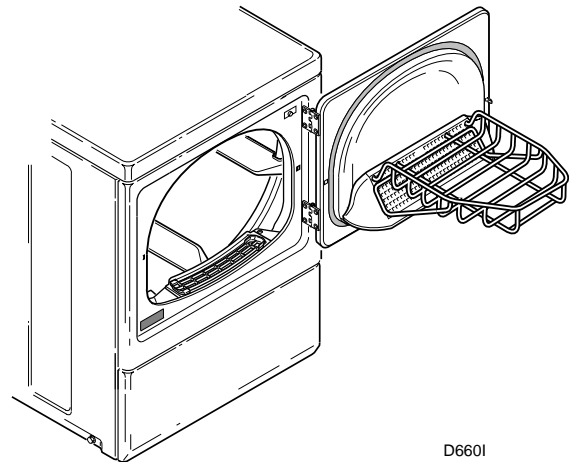

Drying Special Items . . .

Type of Load	Special Instructions
Bedspreads	Choose heat for fabric. Dry one double or two single spreads. Chenille and tufted spreads will shed lint and should be dried by themselves. New spreads especially, will contain loose lint. Tumble on NO HEAT setting before washing to remove loose lint. These spreads may be dried completely.
Blankets Electric Synthetic Fibres Thermal Cotton Wool	<p>DELICATE or NO HEAT cycles. If drying items in dryer is recommended by the manufacturer, dry as for wool. Do not stretch the blanket because of the wiring. Some electric blankets may have an insulation on the the thermostats or on the wiring which will not withstand dryer heat. Do not dryer dry unless the blanket manufacturer says it can be done.</p> <p>DELICATE or NO HEAT cycles. Some of these blankets are fluffy and will shed lint. Tumble on NO HEAT setting before washing to remove loose lint. Use a gentle wash method, then dry in dryer until just dry. The lint filter may need to be cleaned during the drying.</p> <p>AUTOMATIC REGULAR cycle.</p> <p>Agitation and tumbling contribute to the shrinkage and felting of wool. We cannot guarantee that wool will not shrink. However, if care is taken and the blanket manufacturer’s instructions are followed, satisfactory results should be obtained. Wash by the soak method with as little agitation as possible. After washing, stretch blanket gently in both directions. Use approximately five dry bath towels and place them between folds in blanket. This will “cushion” it to lessen the tumbling. Set dryer for 20 minutes on the TIME DRY cycle. Use REGULAR heat setting, if it is available on your dryer. Check blanket when timer reaches 10. Wool blankets must be removed from the dryer when damp. Stretch gently to shape and finish drying over two clothes lines or in a flat position.</p>
Curtains Cotton Fibreglass Synthetic Fibres	<p>AUTOMATIC REGULAR or TIME DRY cycles. Remove damp items for ironing or dry completely, then steam iron.</p> <p>DO NOT DRY IN THE DRYER unless recommended by the manufacturer. Fibreglass may shred. Particles may remain in the dryer and rub off on the next load. This could irritate the skin. “Beta” fibreglass may be dryer dried if recommended by the manufacturer.</p> <p>DELICATE or NO HEAT cycles. Allow room for tumbling to prevent wrinkling. Delicate or sheer curtains must be dried by themselves so they will not be snagged by hooks or crushed by other clothes in the load. Some sheer curtains are heat sensitive. Dry 10 minutes only, plus the cool down period. Remove from dryer immediately and hang. If the dryer has been heated from a previous load, NO HEAT setting may be sufficient.</p>
Denim, Corduroy	AUTOMATIC REGULAR cycle. Dry completely and remove from dryer when seams are slightly wet to minimize shrinkage.

Type of Load	Special Instructions
Draperies	Remove hooks and weights before washing. Choose heat for fabric and allow space in the dryer for tumbling. Some draperies may be removed when slightly damp and hung immediately. Lined draperies should be dry-cleaned because they have a tendency to pucker.
<p data-bbox="110 321 261 352">Knit Articles</p> <p data-bbox="167 516 261 548">Cottons</p> <p data-bbox="167 611 358 642">Synthetic Fibres</p> <p data-bbox="167 800 233 831">Wool</p>	<p data-bbox="539 321 1461 485">Knit fabrics are usually manufactured under tension (stretching). Cotton knits especially may relax or draw together if every bit of moisture is removed from them. It is best to take them out of the dryer with a trace of moisture remaining, then stretch to shape. If they do shrink from overdrying, rewet them and dry properly.</p> <p data-bbox="539 516 1409 579">AUTOMATIC REGULAR or TIME DRY cycle. Remove slightly damp to minimize ironing. Reshape, smooth seams and pockets, etc.</p> <p data-bbox="539 611 1461 774">AUTOMATIC REGULAR or AUTOMATIC PERMANENT PRESS cycle. Turn inside out to prevent “pilling” (the rolling up of the fibre ends from friction). Dry sweaters only with similar things because they tend to attract lint. Make sure the load is large enough for tumbling. Dry completely and remove from dryer immediately to minimize wrinkling.</p> <p data-bbox="539 800 1461 930">DELICATE or NO HEAT cycle. For wool labeled “machine washable”, follow manufacturer’s directions. For other wool, use wool blanket method. Do not dryer dry loosely knit wool or hand knits. Dry these flat and stretch to shape from a pattern drawn before washing.</p>
<p data-bbox="110 951 212 982">Lingerie</p> <p data-bbox="167 1014 250 1045">Cotton</p> <p data-bbox="167 1077 250 1108">Elastic</p> <p data-bbox="167 1203 331 1234">Foam Rubber</p> <p data-bbox="167 1308 269 1339">Spandex</p> <p data-bbox="167 1392 347 1423">Stretch Fabrics</p> <p data-bbox="167 1497 358 1528">Synthetic Fibres</p>	<p data-bbox="539 1014 932 1045">AUTOMATIC REGULAR cycle.</p> <p data-bbox="539 1077 1461 1178">Body oils can cause elastic to deteriorate. Wash garments containing elastic frequently. Elastic in such things as shorts may be dried as for fabric, but avoid overdrying.</p> <p data-bbox="539 1203 1450 1266">Bras, bathing suits, sun suits, etc. DO NOT DRY THESE ITEMS IN THE DRYER WITH HEAT, FIRE MAY RESULT. NO HEAT setting may be used.</p> <p data-bbox="539 1308 1417 1371">Most girdles (control briefs or shapers) today are made from Spandex. Use DELICATE or NO HEAT cycles. Do not overdry.</p> <p data-bbox="539 1392 1461 1455">Choose heat for the most delicate fibre. These may be dried completely as they will stretch into shape. Avoid drying with lint-shedding fabrics.</p> <p data-bbox="539 1497 1461 1682">TIME DRY cycle. Use a DELICATE or LOW HEAT setting, if it is available. Some sheer fabrics, especially sheer knits, can be heat sensitive. Dry these until they are just dry (about 10 minutes) and remove from dryer immediately. Sheer fabrics should not be washed and dried with garments containing hooks or zippers. Man-made fabrics will create static electricity if overdried. To prevent this, use fabric softener and avoid overdrying.</p>
Mattress Pads	The materials in mattress pads is made of either cotton or synthetic fibres. Read the fibre content label, found on your mattress pad, to determine what type of fibre was used to manufacture the pad. READ AND CAREFULLY FOLLOW the fabric care instructions supplied by the mattress pad manufacturer. Some pads made of synthetic fibres are very heat sensitive. These pads can be flammable if over-heated or over-dried. TO AVOID A FIRE HAZARD, DO NOT OVER-DRY mattress pads. Remove pads from the dryer while they are still damp.

Type of Load	Special Instructions
<p>Pillows</p> <p>Feather and Down-Filled</p> <p>Fibre-Filled (polyester)</p> <p>Foam Rubber</p>	<p>Ticking must be strong and seams secure. If in doubt, sew pillow into a case or use a zippered pillowcase to prevent feathers from coming out. After washing, shake pillow to fluff feathers. Dry one large or two smaller pillows. Use TIME DRY cycle. Use LOW or MEDIUM heat setting if it is available on your dryer. Shake and reposition pillows several times during drying. Pillows must be dry in the center to prevent mildew. Drying may take two hours or longer. Reset dryer timer if necessary. The odor of wet feathers is not pleasant. However, the odor will disappear once the pillows dry.</p> <p>Follow manufacturer's directions.</p> <p>Do not dry in the dryer.</p>
<p>Quilts</p>	<p>Choose heat and cycle for fabric. Filling and cover must be completely washable. Old quilts may be too fragile to machine wash or dry. Quilts filled with cotton may become lumpy. Quilting should be close together. Remove from dryer slightly damp and stretch gently to shape. Quilted articles may shrink if overdried.</p>
<p>Rugs</p> <p>Cotton With Cotton Backing</p> <p>Rubber-backed</p> <p>Synthetic Fibres</p>	<p>AUTOMATIC REGULAR or TIME DRY cycles. Dry one large or several small rugs. For one small rug only, add towels for buffers.</p> <p>Hot water and heat tend to deteriorate many types of rubber. Some types of rubber-like materials are flammable under certain conditions. DO NOT DRY FOAM RUBBER AND RUBBER-LIKE MATERIALS WITH HEAT.</p> <p>DELICATE or NO HEAT cycles. Follow manufacturer's suggestions. Some of these rugs are heat sensitive and should be removed from the dryer when damp, or dried with no heat.</p>
<p>Slip Covers</p>	<p>Choose heat for fabric. Close zippers. Dry one couch cover, two chair covers or five or six pillow covers at one time. Remove from dryer when slightly damp. Press pleats if necessary and replace on furniture immediately. Stretch fabrics and knits should be dried completely so they will fit snug when replaced on furniture.</p>
<p>Stuffed Animals and Toys</p>	<p>Make sure the filling and covering are washable and can be dryer dried. Cotton filling may become lumpy. Protect glass eyes by covering with a stocking or tie toy into a pillowcase. Choose heat for most sensitive fibre. Dry enough clothes in the load for good tumbling. DO NOT DRY TOYS STUFFED WITH FOAM RUBBER OR KAPOK IN THE DRYER WITH HEAT.</p>
<p>Tennis Shoes</p>	<p>DELICATE or NO HEAT cycle. Use a drying rack or tumble with at least four old bath towels.</p>

User-Maintenance . . .

Care Of Your Dryer



WARNING

To reduce the risk of an electric shock, serious injury or death, disconnect the electrical service to the dryer before cleaning the interior.

W132

Dryer Interior

Unstable dyes used in many denim blue jeans or brightly coloured cotton garments may cause some discolouration of the interior surfaces. This slight colour change will do no harm to other clothes.

Should you wish to return the interior surfaces to their original whiteness follow the directions below.

The dryer may be cleaned by one of the following methods:

- Wipe the surfaces using a soft cloth and a non-abrasive paste of powdered laundry detergent and hot water followed by a short heat cycle with a load of rags, or
- Apply a liquid spray household cleaner to a soft cloth, wipe the discoloured area and follow with a short heat cycle with a load of rags.

To remove crayon or ball point ink off the dryer drum, put the heat on high and use old rags in the dryer to absorb the crayon or ink. If unsuccessful, contact the appliance dealer. **DO NOT** use any chemicals in the dryer.

IMPORTANT: The use of chlorine bleach for removing any discolourations should be avoided because bleach could damage the finish.

Cabinet

Wipe dryer cabinet as needed. If detergent, bleach or other washing products have been spilled on the dryer top, wipe immediately. Some products will cause permanent damage if spilled on the cabinet.

Do not lay sharp or rough objects on or against the dryer. The finish could be damaged.

Control Panel

Use only a damp or sudsy cloth for cleaning the control panel. Some spray prewash products may harm the finish on the control panel.

Exhaust System

- Keep dryer area clear and free from combustible materials, gasoline, and other flammable vapours and liquids. Do not obstruct the flow of ventilation air.
- The exhaust duct should be inspected after one year of use and cleaned if necessary. Inspect and clean exhaust duct every one to two years as required thereafter.
- Vent hood should be checked and cleaned regularly to assure that it is working properly.

NOTE: Verify proper operation after servicing.

Motor Overload Protector . . .

The dryer's motor overload protector stops the motor automatically in the event of an overload. After cooling, the overload protector will reset itself. Dryer can be

restarted by pushing the timer knob in. If overload protector cycles again, remove the dryer from use and call the service person to correct the problem.

Lint Filter . . .

The lint filter is located at the front of the dryer in the lower part of the door opening.

CLEAN THE LINT FILTER BEFORE DRYING EACH LOAD.

Remove lint filter cover, clean lint filter and replace cover. Annually remove lint filter and screw to vacuum the duct under it.

IMPORTANT: The lint filter must be in place in the door opening when using dryer or loading and unloading dryer. If the filter is not in place, clothing could fall into the front air duct and get into the exhaust system, causing damage to the motor.

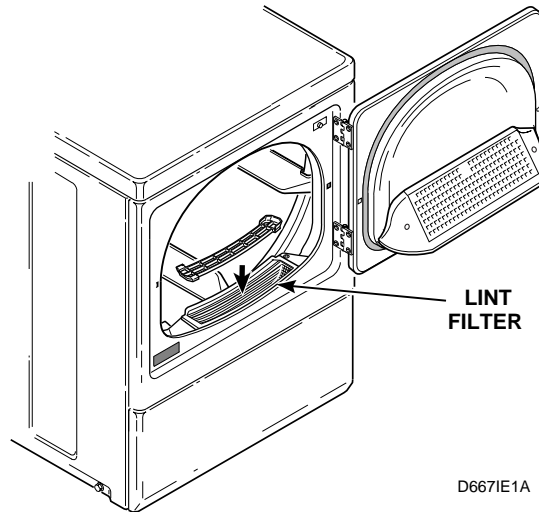

D667IE1A

Before You Call For Service . . .

(You may save time and money by checking the following:)

If Your Dryer:

Won't Start	Won't Heat	Doesn't Dry Clothes Satisfactorily	Possible Reason — Do This To Correct
•			Be sure the power cord is plugged all the way into the electrical outlet.
•			Close the loading door.
	•		Be sure timer is not in COOL DOWN setting or NO HEAT cycle.
•			Push timer knob in to start dryer.
•	•		Has the laundry room fuse(s) blown or become loosened, or are circuit breakers open? The dryer itself does not have an electrical fuse. An electric dryer has an electrical circuit with two fuses.
•			Has the motor overload protector cycled? Wait 10 minutes and try again.
	•		Is the timer in a heat setting?
	•		Gas Dryer Only — Check to see if equipment and main gas line valve is turned on.
	•	•	Check exhaust duct to outside to see if it is kinked, blocked or needs cleaning.
	•	•	Check weather hood to make sure flapper moves freely, has not been pushed in or has not been blocked.
		•	Automatic Cycle — Adjust to more or less dry setting.
		•	Timed Cycle — Allow more or less time.
		•	Clean the lint filter.
		•	Is the load too small? Small loads may not tumble properly or dry evenly.

If Service Is Required . . .

If service is required, contact StGeorge Customer Care Centre on FREECALL 1-800-072-144.

StGeorge
P.O. Box 5560
Maroochydore South QLD 4558
or Phone FREECALL
1-800-072-144

When calling or writing about your dryer, PLEASE GIVE THE MODEL AND SERIAL NUMBERS. The model and serial numbers are located in one of the four corners of the door well. The door well is the shaded area shown.

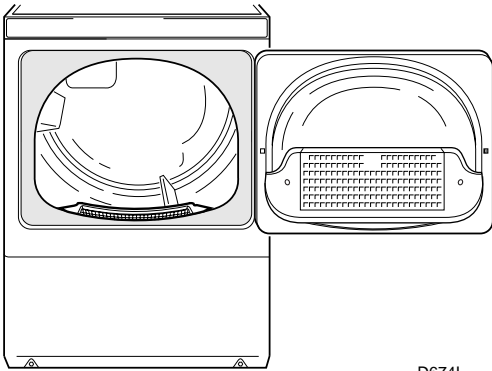

D674I

Please include a copy of your bill of sale and any service receipts you have.



WARNING

To reduce the risk of serious injury or death, **DO NOT** repair or replace any part of the dryer or attempt any servicing unless specifically recommended in the user-maintenance instructions or in published user-repair instructions that you understand and have the skills to carry out.

W133

Automatic Dryer Warranty . . .

Domestic Warranty

Full Five Year Warranty

In addition to all statutory rights which you, the Consumer, have under all the relevant laws in respect of this appliance, during your first five years of ownership as the original purchaser of the StGeorge dryer, we guarantee that any fault caused by faulty material or workmanship, becoming apparent will be rectified free of charge for parts or labour provided that all service is performed during normal working hours by StGeorge or their designated Agent. Where the dryer is installed outside the normal servicing area of the above, the Purchaser must pay the cost of transporting the appliance to and from the Agent or the Agent's travelling cost to and from the Purchaser's home.

Commercial Warranty

Full One Year Warranty

In addition to all statutory rights which you, the Consumer, have under all the relevant laws in respect of this appliance, during your first one year of ownership as the purchaser of the StGeorge dryer, we guarantee that any fault caused by faulty material or workmanship becoming apparent will be rectified free of charge for parts or labour provided that all service is performed during normal working hours by StGeorge or their designated Agent. Where the dryer is installed outside the normal servicing area of the above, the Purchaser must pay the cost of transporting the appliance to and from the Agent or the Agent's travelling cost to and from the Purchaser's home.

What These Warranties Do Not Cover

We are not responsible for any damage or malfunction unless caused by a defect in material or workmanship. This includes, but is not limited to, abuse, misuse, improper installation, and transportation damage. We are not responsible for any consequential damages resulting from any malfunction.

Information For Handy Reference . . .

StGeorge
P.O. Box 5560
Maroochydore South QLD 4558

Date Purchased _____

Model Number _____ Serial Number _____

Store Name _____

Store Address _____ Phone Number _____

Service Agency _____

Service Agency Address _____ Phone Number _____

NOTE: Record this information and keep your sales slip. Model and serial numbers are located on the nameplate.

**Customer Care Centre and
Information Freecall:**

1-800-072-144