

Cooking collection

Instructions for Use and Warranty Details

CH605CM - 600mm Manual Control Ceramic Cooktop



Congratulations on the purchase of your new appliance. This appliance has been designed and manufactured to give you years of reliable performance.

For best results, carefully read the instructions on how to install your new appliance. Correct installation will avoid delays and unnecessary service calls.

Once installation is complete, read this booklet carefully and get to know the controls and the features of your new appliance.

We reserve the right to alter the specifications with no influence on the operation of the appliance. This instruction manual cannot be reason for a claim.

Ceramic-glass Built-in Cooktop

This built-in Ceramic-glass cooktop is made for domestic use only.

For best results, carefully read the instructions on how to install your new appliance. Correct installation will avoid delays and unnecessary service calls.

Our appliances are packed in environmentally friendly materials which may be recycled, deposited or destroyed without any hazard to the environment. Such packaging materials are also labelled accordingly.

Once the life cycle of your appliance is over, ensure you do not to pollute the environment. Deliver it to an authorised collector of used household appliances

Instructions for Use

These instructions are intended for the user. They describe the cooker and how to use it. They also apply to different types of appliances, therefore you may find some descriptions of functions that may not apply to your appliance.

Instructions for Installation

This appliance should be connected to the power supply according to instructions for the connection of appliances in compliance with current standards and local regulations. Electrical connection should be carried out by a qualified technician only.

Rating Plate

The rating plate with basic data is fixed on the rear wall of the appliance.

Fire hazard protection

The appliances can be mounted on one side next to a high kitchen cabinet, the height of which may exceed that of the appliance. On the opposite side however, only a kitchen cabinet of equal height as the appliance is allowed.

Ceramic-glass Built-in Cooktop	3	Pots and Pans	7
Instructions for Use		Energy Saving Tips	
Instructions for Installation		Cleaning and Maintenance	8
Rating Plate		Mounting the built-in cooktop	9
Attention	4	Caution !	
Technical Data	4	Dimensions of the built-in hob opening	
Glass Ceramic Cooktop	5	Installation procedure	
Setting of Cooking Zones	6	Electrical connections	10
Use of Cooking Zones		Connecting to Power Supply	10
The Circuit and Extended Circuit Switch		Connecting diagram	10
Signal lamp			
Warning lamps "HOT"			

Attention

- The appliance may be installed and connected to mains by qualified personnel only.
- Particular areas of the appliance get hot during operation (vicinity of the heating plates). Make sure children are kept out of reach and warn them accordingly.
- Overheated oil may suddenly ignite. Constant monitoring should therefore be assured during the preparation of such dishes that require the use of oil (chips).
- Do not leave an empty pan on a heating zone.
- Do not use the appliance for room heating.
- Do not use the glass ceramic plate as a working top. Sharp objects may cause scratches.
- Do not drag saucepans across the hob surface, as in the long term this will damage the ceramic top.
- Do not place saucepan lids on the cooktop surface. Extreme pressure can build up while cooling and cause the ceramic top to crack!
- If any other electric appliances are plugged in close to the hotplates, prevent the cord coming into contact with the hotplate.
- Do not store any temperature sensitive objects below the hotplates, like cleaners, sprays, etc.
- Do not use copper, earthenware or aluminium pots on the cooktop as they may scratch or stain the cooktop. Do not place any plastic objects or aluminium foil upon hot plates.
- Do not use cracked or broken glass ceramic plates. If a crack is detected, switch off the electric supply immediately.
- In case of any failures disconnect the appliance from mains and call your nearest authorised Kleenmaid service agent on 1300 652 100.
- **Warning!** The appliance is not intended for use by young children or infirm persons without supervision. Children should be supervised to ensure that they do not play with the appliance.

Technical Data

Type	CH605CM (SVK65ES)
Mains voltage	2N AC 400 V
Operating voltage	230 V, 50 Hz
Type of control knobs	E= sliding increase of power with power regulators
Cooking zones (ϕ mm/kW)	HL=HI- light plate HA=halogen plate
Front left	210/120/2,2/HL
Rear left	145/1,2/HL
Rear right	180/1,8/HL
Front right	145/1,2/HL
Total power (kW)	6,4

Glass Ceramic Cooktop

The glass ceramic cooktop has four heating zones. Its surface is flat and there are no edges where food remains usually collect.

- The heating zone reaches the preset temperature quickly, yet the area around the hot cooking zone remains cool.
- The hob is resistant to temperature changes.
- Never use the ceramic hob as a working surface. Sharp objects may scratch it.
- Preparation of food in aluminium or plastic pots or dishes on hot cooking plates is not allowed. Do not place any plastic objects or aluminium foils upon the cooktop surface.
- Do not prepare coffee in small traditional coffeepots if the diameter of the pot is smaller than the cooking area as it may result in damage.
- Do not use aluminium, earthenware or copper pots or pans as they may scratch or stain the ceramic glass.
- Do not place saucepan lids on the cooktop surface. Extreme pressure can build up while cooling and cause the ceramic top to crack!
- The ceramic surface is very strong, however, it is not unbreakable. Breakage from excessive force or impact may void warranty.

WARNING!

- Never use a cracked or broken ceramic hob. The hob may break or crack if an object with sharp edges falls on it. The crack may be visible immediately or only after some time. Disconnect the appliance from mains immediately in case any cracks are detected upon the glass ceramic surface.
- If you spill sugar or any other sweet substance, wipe the hob immediately, with a clean cloth or use a scraper even though the cooking area is still hot. This will prevent damage to it.
- Never use ordinary cleaning agents for cleaning the ceramic glass cooktop, as they may damage the ceramic glass surface.

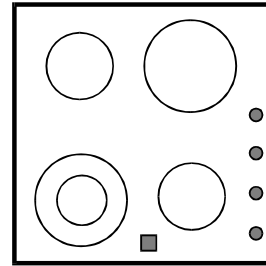

Setting of Cooking Zones

The cooking zones are controlled by knobs mounted on the control panel of the cooker. The heating degrees are marked on the knobs from 1 to 6 (gradual increase), or 1-9 (continuous increase), whereby position 1 is the lowest and position 6 or 9 respectively the highest setting. The heating is switched off in position 0. The intermediate settings can also be selected and set in two ways: in stages or continuously. The knob can be turned in both directions. Energy knobs increase power if turned clockwise and decrease if turned in opposite direction.

Use of Cooking Zones

SE

- 0** Cooking zone switched off
- 1-2** Maintaining the temperature and warming up smaller quantities of food
- 3-4** Warming up
- 5-6** Warming up or slow cooking of large quantities of food
- 7** Baking in turns (like pancakes..)
- 8** Frying
- 9** Quick heating up

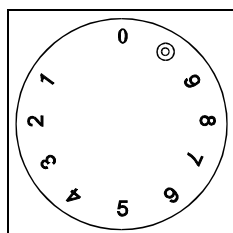
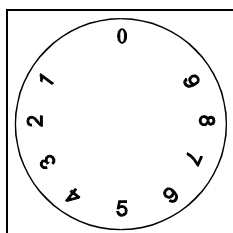

Signal lamp

Signal lamp ON (red) is on when at least one cooking plate is switched on.

Warning lamps "HOT"

Glass ceramic cookplates are equipped with warning lamps "HOT". The lamp, switched on at any particular time, signals that the relevant cookplate is hot (danger of burns). When the cookplate is switched off, the lamp remains on until the temperature of the cookplate falls below 50°C.

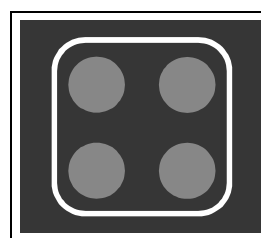

The Circuit and Extended Circuit Switch

During normal turning of this knob, the basic plate is switched on first (inner circuit). To switch on the second and the extended circuit, turn the knob until the double circuit mark appears ⊙ and a "click" is heard and then turn it back to selected position.

To switch off the complete plate, simply turn the knob back to position 0.

- 1** Double circuit cooking plate
- 2** Control lamp ON
- 3** Warning lamps "HOT"
- 4** Setting knobs

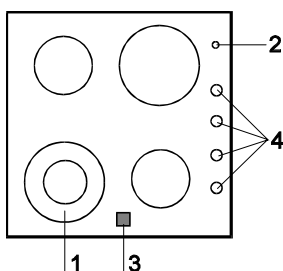

Pots and Pans

Use only high quality pots with a flat and stable base.

- Always be careful to put the pot in the middle of the cooking zone.
- If you use the pots made of temperature resistant glass always consider the manufacturer's instructions.
- If you use a pressure cooker, never leave it unattended. Select the highest temperature setting, wait until the correct pressure is reached in the pressure cooker and turn the knob to a lower setting, as recommended by the manufacturer of the pot.
- When using high radiation (bright metal surface), or thick base pots for preparing food on the glass ceramic hob, the period of reaching the boiling point may be prolonged for certain time (up to 10 minutes). Consequently, if you need to boil considerable amount of liquid, it is recommended to use a dark, flat base pot.

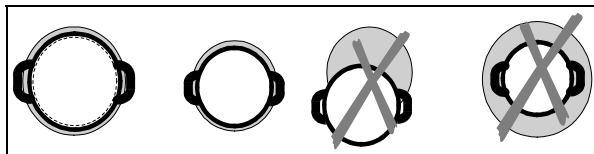

The cooker top can be damaged if:

- Switched on and left uncovered or with an empty pot on it,
- If you use incorrect pots with an uneven base, rough **or too small diameter base** (traditional coffee pan).
- Never use aluminium, earthenware or copper pots as they are very likely to scratch or stain the ceramic glass surface.
- Before putting the pot on the hot plate, thoroughly wipe the base of the pot dry to provide unobstructed thermal conductivity and to prevent damage to the hotplate.
- If you place saucepan lids on the cooktop surface. Extreme pressure can build up while cooling and cause the ceramic top to crack!

Energy Saving Tips

- The inside base of the pot should be slightly concave for optimum heat transfer from the cooking zone.
- The base of the pot should always suit the size of the cooking zone. If the pot is smaller, it can cause energy loss and if larger, the cooking zone may become damaged.
- Use a pot lid whenever possible.
- The pot size should suit the quantity of food. Cooking smaller quantities of food in a large pot results in energy loss.
- Food which needs longer cooking should be prepared in a pressure cooker.
- Vegetables should be cooked in small quantities of water. This speeds up the cooking time, especially if the pot is properly covered. Reduce the cooking power when the boiling point is reached.
- Switch the hotplate off 5 to 10 minutes prior to the end of cooking.

Cleaning and Maintenance

The ceramic-glass cooking hob must be cleaned and cared for regularly. Use only reliable and verified cleansing agents, designed specially for ceramic-glass surfaces. Any attempt to use other detergents may result in considerable damage, as they may be too invasive and damage the surface or produce scratches.

Clean the cooktop surface only when cold or at least cooled down, except in case of spilled sugar or strongly sweetened food, as described before. In such case wipe the surface immediately and remove the sugar residues with a scraper although the cooking zone is still hot, or else the hotplate may be damaged beyond repair.

- Regular cleaning is extremely simple. Usually it is enough to wipe the ceramic-glass surface with a wet cloth and dry it with a dry napkin before and after use. This will protect the cooktop both before use, by removing any dust and dirt particles that might produce scratches when moving the cookware about, as well as after use, by maintaining it and preventing deterioration. If the ceramic-glass surface is not properly cleaned it may soon lose its natural shine.
- Dried stains or discolouring of the cooktop (as a consequence of incorrect detergents or incorrect cookware) may be possibly be removed with verified and reliable detergents, specially designed for ceramic-glass surfaces. Apply the concentrated detergent to the surface. Allow some time penetrate and wipe it off with a wet cloth (except if instructed otherwise by the detergent manufacturer).
CAUTION ! When applied on a hot surface, the cleaning agent may damage the ceramic glass cooktop!
- Heavily dried or burnt stains may be removed with a scraper.
- The surface may be protected from damage by regularly cleaning the cooktop using the recommended cleaning agents.
- Never use sponges previously used for washing the dishes. They usually contain alkaline substances that may result in discolouring the cooktop surface.

Mounting the built-in cooktop

Caution !

- To avoid any possible hazard, the appliance may be installed by qualified personnel only.
- Panels and furniture lining of the kitchen cabinet receiving the hob must be treated with temperature resistant adhesives (100°C), otherwise they might be discoloured or deformed because of inadequate temperature resistance.
- The cooking hob is intended for building into the worktop above the kitchen element of 600 mm width or more.
- After the installation of built-in hob make sure that there is free access to the two fixing elements in front.
- Suspended kitchen elements above the cooktop must be installed at such distance to

provide enough room for comfortable working process.

- The distance between the worktop and the hood must be at least such as indicated in the instructions for installation of the kitchen hood, but in no case it may be less than 650 mm.
- The smallest distance between the edge of the appliance and the adjacent high kitchen cabinet is 40 mm.
- The use of hard wood decorative borders around the worktop behind the appliance is allowed, in case the minimum distance remains as indicated on the installation illustrations.
- Minimum distance between the built-in cooktop and rear wall is indicated at the illustration for the installation of the built-in cooktop.
- The appliance may be installed in any worktop with a thickness from 30 mm to 50 mm.

Dimensions of the built-in hob opening

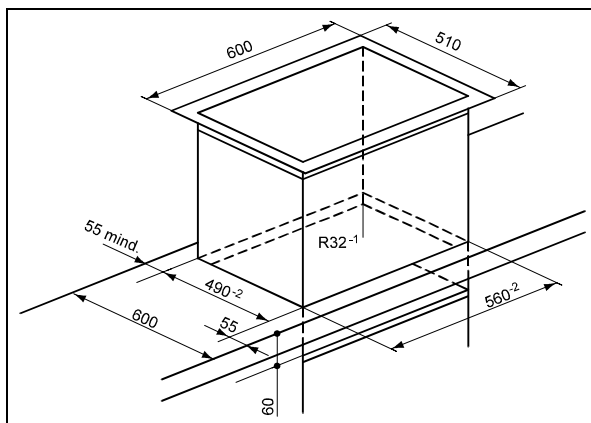

Installation procedure

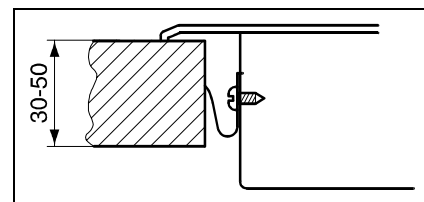

- Worktop must be placed absolutely horizontal.
- Suitably protect the edges of the cut aperture.
- By means of the supplied screws 4 (or 6 by some models) fasten the supplied tightening brackets 4 (or 6 by some models) fasten to the front and the rear side of the cooking hob and to the prepared aperture.
- Connect the cooking hob to the mains power supply (see instructions for the connection of the cooking hob to mains power supply).
- Insert the hob into the cut aperture.
- Press the hob firmly towards the worktop from above.

Electrical connections

- The electric built-in cooktop has to be mounted and installed by a qualified technician. The protection of the electrical wiring shall comply with current standards and regulations.
- Before connecting the appliance to the power source, make sure that the voltage stated on the rating plate complies with the voltage of your power supply.
The rating plate of the ceramic glass hob is fixed on the lower side of the hob.
- The cooker shall be connected to 240 V AC.
- Electric connections shall be of such design, to incorporate a protection device between the appliance and the supply, like fuses or FI switches (to assure at least a 3 mm clearance between the contacts in open position).
- Electrical connection should be made considering the current capacity of the installation and the fuses.

- Fire protection is of class Y, which means that the appliance may be mounted between two kitchen units; one of them may be higher than the appliance itself, the other has to be of the same height.
- After mounting, the live parts and insulated parts of the appliance should be protected against accidental contacts.
- The distance between the ceramic glass hob and the hood should be at least the distance as stated in the instructions for mounting the hood.
- No kitchen furniture drawers are allowed to be mounted below the glass ceramic cooktop.

Connecting to Power Supply

Power supply may be connected by the qualified technician only. Connecting sockets are available when you open the connecting box cover.

WARNING!

Before repairing or servicing, disconnect the power supply. According to the mains voltage the appliance should be connected in line with the displayed diagram. Protective conductor (PE) should be connected to the socket marked EARTH \perp .

Connecting cable should be inserted through the clamp device to prevent eventual pullout. Upon completion of power connection switch on all hotplates for about 3 minutes to check they are functioning properly.

Connecting diagram

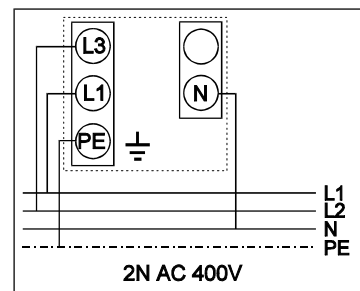

- Following cables may be used for connection:
- rubber connecting cables type H05 RR-F 4X1,5 with yellow-green protection conductor;
 - PVC insulated connection cables type H05 VV-F 4x1,5 with yellow-green protection conductor or
 - any other suitable cable of equal or better properties.

WE RESERVE THE RIGHT TO ALTER THE SPECIFICATIONS WITH NO INFLUENCE TO THE OPERATION OF THE APPLIANCE.

WARRANTY AND SERVICE

DOMESTIC WARRANTY - FULL FIVE YEAR WARRANTY

In addition to all statutory rights which you, the Consumer, have under the relevant laws in respect of this appliance, during the first five years of ownership as the original purchaser of this Kleenmaid appliance, we guarantee that any fault caused by faulty material or workmanship becoming apparent will be rectified free of charge for parts and labour, provided that all service is performed during normal working hours by Kleenmaid or their designated Agents. Where the appliance is installed outside the normal servicing area of the above, the Purchaser must pay for the cost of transporting the appliance to and from the Agent or the Agent's travelling cost to and from the Purchaser's home.

COMMERCIAL WARRANTY - ONE YEAR WARRANTY

When this appliance is installed in a commercial application, you, the Consumer, have under the relevant laws in respect of this appliance, during your first one year of ownership as the original purchaser of this Kleenmaid appliance, we guarantee that any fault caused by faulty material or workmanship becoming apparent, will be rectified free of charge for parts and labour, provided that all service is performed during normal working hours by Kleenmaid or their designated Agents. Where the appliance is installed outside the normal servicing area of the above, the Purchaser must pay for the cost of transporting the appliance to and from the Agent or the Agent's travelling cost to and from the Purchaser's home.

WHAT THESE WARRANTIES DO NOT COVER

We are not responsible for any damage or malfunction unless caused by a defect in material or workmanship. This includes but is not limited to abuse, misuse, improper installation and transportation damage. We are not responsible for any consequential damages from any malfunction.

The Consumer must make the appliance available for servicing and shall bear any costs incurred for any de-installation and/or re-installation required to make the appliance available for servicing. Kleenmaid is not liable for any consequential damage incurred during de-installation or re-installation.

WARRANTY DOES NOT COVER REPLACEMENT OF LIGHT GLOBES OR GLASS BREAKAGE DUE TO IMPACT

In case of fractured glass do not use your appliance.

WARRANTY REGISTRATION

Please complete warranty details below. Please retain together with your proof of purchase document. These documents will need to be viewed by our Service Representative should you request in warranty service.

SERVICE ASSISTANCE

To assist you when phoning our After Sales Service number to arrange a service call please complete the following details and have them ready when you call.

Model Number _____ Date of purchase _____

Kleenmaid Store purchased from _____ Date of installation _____

KLEENMAID AFTER SALES SERVICE
1300 652 100

Other products available in the Kleenmaid Range of appliances

Washers

Dryers

Dishwashers

Ovens

Cooktops

Outdoor Cooking Centres

Built In Coffee Machines

Rangehoods

Freestanding Ranges

Sinks

Waste Disposals

Taps

Cookware

Refrigerators

Freezers

Wine Cellars

Vacuum Cleaners

**For sales information on the full range of quality appliances
Phone 13 13 08**

