

# DISHWASHER

c o l l e c t i o n



## Instructions for Use and Warranty Details

---

Dishwashers    DW10W -    White

                         DW10X -    Stainless Steel

The logo for Kleenmaid, featuring a stylized 'K' icon to the left of the brand name 'KLEENMAID' in a bold, sans-serif font. Below the brand name, the tagline 'THE WORLD'S BEST' is written in a smaller, all-caps, sans-serif font.

**KLEENMAID**  
THE WORLD'S BEST



Congratulations on the purchase of your new Kleenmaid appliance. This appliance has been designed and manufactured to give you years of reliable performance. For best results, carefully read the instructions on how to install your new appliance. Correct installation will avoid delays and unnecessary service calls.

Once installation is complete, read this booklet and get to know the controls and the features of your new appliance.

If you need further information call our

**After Sales Service**

**I 300 652 100.**

We reserve the right to alter the specifications with no influence on the operation of the appliance. This instruction manual cannot be reason for claim.

# CONTENTS

	Page
Safety advice	5
Installation	6-7
Adding rinse aid	7
Loading the dishwasher	8
Adding washing detergent	9
Choice of programmes	10
Glassware, Pots and Silverware	11
Cutlery, China and Woodware	11
Technical characteristics	12
Installation	12
Instructions for cleaning and maintenance	13
Troubleshooting	14
Illustrations 1 - 4	15
Illustrations 5 - 13	16
Warranty and Service	

**BEFORE READING THESE EXPLANATIONS, CONSULT THE ILLUSTRATIONS  
ON THE PAGES 15-16 OF THIS INSTRUCTION MANUAL**

---



## SAFETY ADVICE

Please read the instructions in this booklet carefully. You will find instructions necessary for security, installation and using your machine as well as the guarantees. We advise you to keep the booklet and pass it on if you sell the machine.

We cannot except responsibility if the instructions below are not followed :

- Please destroy the packaging in an appropriate way and in compliance with environmental protection legislation.
- If the machine is visibly damaged, do not connect it and contact your dealer.
- It should be placed in a frost-free area. In case of frost, the hydraulic systems may be damaged.
- The water supply and evacuation pipes must be connected according to instructions. Incorrect connections may cause damage.
- To ensure proper stability, built-in machines should be installed below a continuous work surface fixed to the adjoining cabinets.
- You should not stand or lean on the open dishwasher door. The machine could tip over or be damaged.
- The machine is intended to wash dishes and should not be put to other uses.
- Using solvents to clean or maintain your machine is highly unsuitable.

You should store dishwasher products as well as other cleaning products out of the reach of children. These products have a corrosive effect on the mouth and pharynx if they are swallowed.

- If the machine malfunctions due to other causes than those mentioned in this booklet, disconnect the machine (remove the plug) or break the circuit concerned and contact our after-sales service.
- The machine complies with applicable safety regulations. Any repairs should only be carried out by qualified technicians. Repairs or changes that do not conform may be dangerous for the user. In case of replacement, only use original parts.
- Broken machines should be taken to the closest recycling centre. Destroy the door closing system so it no longer works (children may close themselves in whilst playing and suffocate). Cut the electric cable after having removed the plug from the socket.
- You are strongly advised to disconnect the machine after use and turn off the water supply.
- Do not let children play with the machine or touch it.
- The water inside the machine is not suitable for drinking.
- When the machine is running, do not open the door. This may provoke important steam leakage or splattering of water.

# INSTALLATION

**IMPORTANT ! : KLEENMAID RECOMMENDS THAT YOUR DISHWASHER BE INSTALLED BY AN AUTHORISED KLEENMAID INSTALLER OR SERVICE AGENT !!**

**Before you start :**

- 1 . These instructions are intended as a guide only. It is the responsibility of the Plumber and Electrician to ensure that each installation complies with local by-laws.
- 2 . Connection to cold water is recommended.
- 3 . When installing the Dishwasher, check that the drain hose does not become restricted or kinked.

**Levelling : Adjusting the feet (Fig. 4) :**

Make sure that the machine is properly upright and stable. The four feet may be altered, adjust them if necessary using a wrench or a screwdriver. Badly adjusted feet may move the door off centre and make the machine unstable.

***IMPORTANT : Do not connect the dishwasher to the power or water supply before completing installation.***

If you are installing your dishwasher on carpet, adjust the feet so that you leave space for air to circulate underneath the machine.

**Fitting your machine into your kitchen :**

The building in sizes for the machine are given in the "technical characteristics" chapter on page 12.

**Plumbing :**

**. Water Supply (Fig. 2)**

- a . The water supply to the Dishwasher should not be less than 12 mm domestic water pipe. A readily accessible tap must be installed in the supply pipe.
- b . The inlet connection hose supplied is fitted to a 3/4" BSP male thread, which must have an adequate sealing face for the washers supplied.
- c . The water supply pressure is to be between 21 kPa (4.0 psi) minimum and 970 kPa (140 psi) maximum.

If pressure is greater 100 psi, it is recommended to fit a pressure limiting valve to prevent damage from rises and increased pressure of peak demand.

## INSTALLATION CONTINUED

### Evacuating waste water (Fig. 3)

Connect the waste pipe

A. Either to the ventilated siphon. The waste pipe must be free in the siphon and should be no deeper than 20 cm.

B. Or on the sink siphon. Be careful not to forget to remove the siphon cover.

Be careful to fix the waste pipe down with a tie to avoid any flooding. In any case, the end of the pipe must be between 60 cm and 1 m high. Avoid folding the pipe when installing.

- Horizontal drain lines should not exceed 5 m length.

- Ensure that the drain hose is fully extended and not restricted in any way.

**NOTE : Do not connect drain hose directly to a waste disposal unit as blocking with food waste will occur.**

### Connecting to the power supply :

You should use an earthed plug to connect to the power supply. In case of a direct connection, the main switch terminal should be at least 3 mm apart.

The electric plug should remain accessible. Do not use an extension lead or multiple plug.

• **We cannot be held responsible for any incident caused by the machine being badly earthed.**

In any case, the machine must be fitted in compliance with the applicable regulations in your state as well as any extra instructions from the Electricity Company. The machine's approval and model are indicated on the sticker fixed to the left-hand side of the door. The machine must be turned off when connecting to the electric circuit.

## ADDING RINSE AID

Rinse aid is necessary as it avoids stains on the dishes and makes drying easier.

**IMPORTANT ! Only use products intended for dishes and NOT detergents intended for hand washing !**

We recommend using Kleenmaid Dishwasher Rinse Aid. Please phone our After Sales Service on 1 300 652 100 for the Store nearest you.

### Filling and adjusting the rinse aid container (Fig. 5-6) :

Put the door in a horizontal position when filling the container and unscrew the cap in the door counter clockwise.

Fill to just below the adjusting lever.

If the product overflows on filling, remove the excess with a sponge to avoid any foam forming.

If you experience stains or bad drying after several cycles, you may adjust the dosage using the selector :

Soft water : level 1 to reduce the dose

Hard water : level 3 to increase it.

### For child safety :

Dishwashing detergent and rinse aid should be treated as poisons and stored where they are not accessible to children.

## LOADING THE DISHWASHER

For best washing results, be careful before loading dishes to remove important food residue. Any burned or stuck leftovers should be removed.

Your dishwasher has two baskets for 14 place settings (162 pieces) according to AS 2007 (Fig. 10 and 12). Always turn the inside of the dishes towards the bottom. Be sure that no dish hides others and the spray jet is not obstructed. Check that the spray arm is free to rotate. No dish should be higher than the basket.

### Lower basket (Fig. 7-9-10)

Place the dishes so that water may circulate freely and spray all the utensils. (Avoid attaching and piling dishes up).

This basket is especially intended to hold: plates, cutlery, dishes, frying pans, saucepans. Dishes and frying pans can be placed on the right-hand side or even in the front.

Avoid mixing plates and soup dishes. You should preferably place same-sized plates together.

Place soup dishes at the back, in the high pin area.

Make sure nothing obstructs the rotation of the lifting arm (saucepan handles, cutlery or large dishes).

**The cutlery baskets** are sliding and can be placed in any area of the lower basket meaning that you can change the layout according to the type of dishes you are washing.

Removable grills are adaptable to cutlery baskets allowing you to arrange cutlery, especially small spoons, as you wish.

For optimum washing, you can use the separation grids.

### Cutlery (Fig. 8)

- Place handles downwards.
- It is preferable to place small spoons in the separating grills.
- Avoid washing wooden, bone or hollow handled cutlery in the machine.
- Separate silverware from other metals using the separating grill.

**Important note** : For reasons of safety, we recommend you place sharp-ended table knives blade down in the cutlery basket.

Long-bladed cutlery and other sharp utensils should be placed flat in the upper basket.

### Upper basket (Fig. 11-12)

This basket is particularly intended to hold glasses, cups, small salad bowls, bowls, saucers etc... Place glasses so that they do not touch and tip them sufficiently so that they do not retain any water. Arrange the dishes in rows of glasses, cups, and bowls to gain space.

Use the height adjustable holding bar for large or large-stemmed glasses.



## ADDING WASHING DETERGENT

The washing product container has been placed in front of the upper basket to make the machine easier to fill. This means that you can load the washing powder without bending down or completely opening the door. Use washing products specifically designed for dishwashers, either tablets, powder or liquid detergent.

We recommend using Kleenmaid Dishwasher Powder and Rinse Aid. Please phone 13 1308 for the Store nearest you.

### Before running a programme :

- Put the tablet in the outside compartment.

### OR

- Pull the distributor to fill with powder or liquid and fill up to the minimum level for slightly dirty dishes and to the maximum for dirty dishes.

Close the distributor.

See the manufacturers' recommendations on the packet as well as the advice for use below.



*tablet*

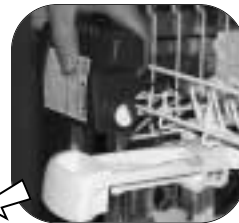

*powder or liquid*

### For child safety

**Warning - Dishwasher detergents are strongly alkaline. They can be extremely dangerous if swallowed. Avoid contact with skin and eyes and keep children away from the dishwasher when the door is open.**

**Check that the detergent receptacle is empty after completion of the wash cycle !**

# CHOICE OF PROGRAMMES

1 = Prewash : 

Very short cycle, without detergent, rinses dishes before washing the next day or the day after.

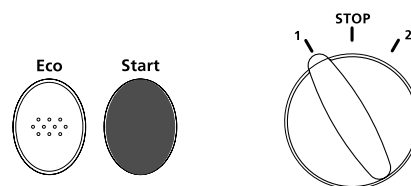

2 = Wash 60 °C : 

Recommended for very dirty or greasy dishes (difficult stains : fat, sauce, cooking or frying stains...).

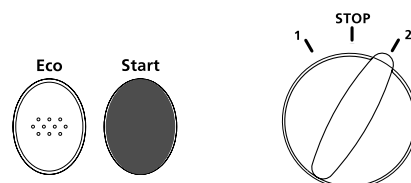

2 + Eco = Wash 50 °C : 

Recommended for normally dirty dishes (daily stains).

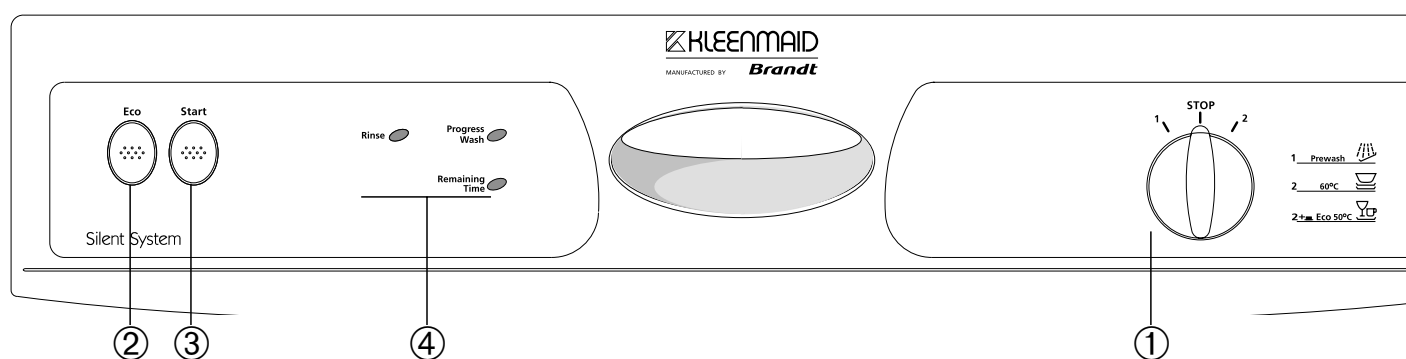
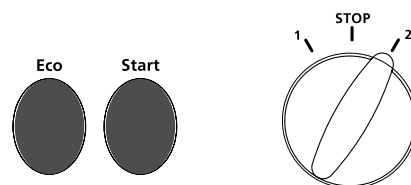

- ① Programme button
- ② Option button
- ③ Start button
- ④ Indicator lights :

- Rinse Aid Required - Refer Page 7
- Wash in Progress : means that the cycle timer is in progress.
- Time Remaining : means that it remains 15 mins before the end of the cycle.

### For information purposes :

	Duration	Water	Electricity
1 - Prewash	5 mins	5 L	0.1 kWh
2 - Wash 60 °C	80 mins	24 L	1.65 kWh
2 + Eco Wash 50 °C	74 mins	24 L	1.47 kWh

## GLASSWARE, POTS AND SILVERWARE

### Glassware

Most glassware is dishwasher safe. We do not recommend washing crystal items in the dishwasher, as crystal is not dishwasher safe.

### Pots and Saucepans

- Pots and saucepans can be washed in the dishwasher. Scrape off food scraps and put items in the baskets upside-down.
- Stainless steel can be washed in the dishwasher.
- As when hand washed, aluminium is dulled by being washed in the dishwasher.

### Silverware

- All silverware should be rinsed immediately after use to prevent discolouration caused by some foods. The "Waiting dishes" programme is useful for this situation.
- Old silverware and hollow handle knives with adhesives securing the handles should be washed by hand.

## CUTLERY, CHINA AND WOODWARE

### Cutlery

- Stainless steel and silver should not be allowed to come into contact with each other, as this can stain the silver.
- Remove sterling and silver plated cutlery from the dishwasher and hand dry it immediately after the programme has finished.
- Wooden, bone and plastic handles can be sensitive to higher water temperatures. The appearance of these items may change over time if washed in the dishwasher.

### Woodware

Generally wooden items are sensitive to heat and water. Regular use in the dishwasher may alter their appearance. We suggest you wash wooden items by hand.

**Remember, if in doubt about any aspect concerning materials washed in the dishwasher, follow manufacturer's instructions or wash the item by hand.**

### Decorated China and Tableware

- Most current china patterns are dishwasher safe. However, we advise checking with their manufacturer.
- Older items with the design over the glaze, ie. gold rims and hand-painted China may be more sensitive to machine washing. If in doubt, wash these items by hand.

## TECHNICAL CHARACTERISTICS

Voltage : 230-240 V – 50 Hz – Fuses : 10 A  
Power : 2150-2300 W  
Capacity : 14 place settings

Water pressure : 3 psi/21 kPa min  
100 psi/690 kPa max  
Water evacuation pipe height : 60 cm - 1 m

### COMPARATIVE TESTS ACCORDING TO : AS/NZS 2007 : 98

Programme "2 + Eco Wash 50 °C  "

- Rinse aid dispenser setting on : 3
- Quantity of washing product : 40 g.
- For the determination of Drying Index the door of the dishwasher was opened approximately 240 mm at the end of the programme for 30 minutes.

## INSTALLATION

### Building the free-standing machine in

If you install the dishwasher built-in under an existing worktop, **you must attach it with the front bracket to a fixed worktop**. If installing in this way, proceed as follows:

- Remove the worktop by unscrewing the 2 screws under the edge of the upper plate.
- Fit the dishwasher into its housing.
- Adjust the height of the feet if necessary (fig. 4).
- Use two screws to fasten the front bracket to the kitchen worktop, so as to make your dishwasher fast.

**For safety reasons Kleenmaid recommends that your dishwasher is not installed directly below a cooktop. If installation is carried out in this manner your warranty may be void.**

**NOTE :** These measurements are shown without worktop fitted. If installing with worktop fitted :

- 1 - To over all height add 32mm
- 2 - To overall width add 4mm
- 3 - Overall depth of worktop from rear to front comers = 581mm
- 4 - Overall depth of worktop from rear to centre front 600mm

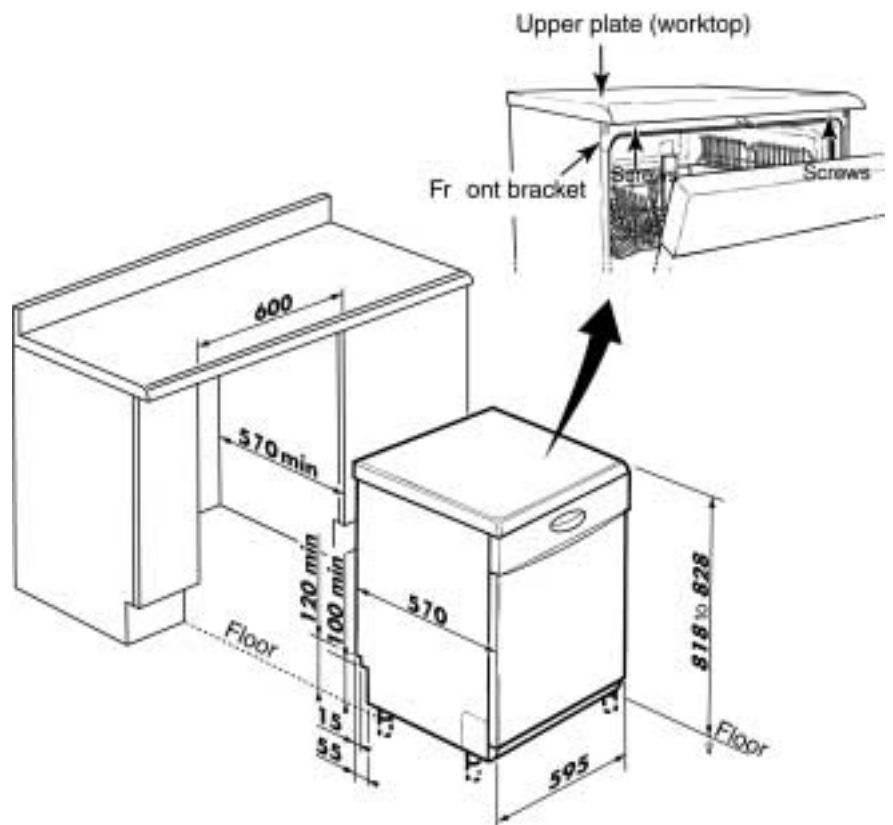

## INSTRUCTIONS FOR CLEANING AND MAINTENANCE

- Your dishwasher comes with a self-cleaning pulse filter that constantly filters small particles of dirt trapped in the washing bath. The filter and the main filter cannot be dismantled as the cleaning arm constantly cleans them.

Regularly clean the waste trap.

Pull the handle (**Fig. 13**), remove the residue with a brush and clean with tap water. Put back in to its housing making sure you clip it down properly.

### Clean as necessary

- Underneath the filters, around the door and the door joint with a damp sponge to remove any deposit.
- Use only soap and water for the body and control panel.
- Do not clean with abrasive powders, scouring pads, spirit-based products or solvents. Preferably use a cloth or a sponge.

- If you have a stainless steel door you may use products adapted for stainless steel. See the manufacturer's instructions for advice on their use.

We recommend using 3M Stainless Steel Cleaner. Please phone our After Sales Service on 1 300 652 100 for the Store nearest you.

### Every year

To maintain your machine in perfect working order you should clean it once or twice a year. Run on "Very dirty dishes" programme with the machine empty and a special dishwasher cleaning product available from any reputable dealer.

### Prolonged period of non-use

Clean your machine completely then unplug the electricity supply and close the water tap.

## TROUBLESHOOTING

Problems	Causes
The dishwasher will not start	<ul style="list-style-type: none"> <li>- Is it plugged in ?</li> <li>- Is the door properly closed ?</li> <li>- Is the water connected ?</li> </ul>
The dishes are not properly washed	<ul style="list-style-type: none"> <li>- Programme choice. Choose the programme best adapted to the type of wash</li> <li>- Make sure nothing is blocking the circulation of the water</li> <li>- Check the dishes are properly arranged.</li> <li>- Only use specially designed washing products</li> <li>- Check the waste well, filters, arms, joints and door rim are clean</li> <li>- Clean the filter</li> <li>- Check that the washing arm can freely rotate</li> </ul>
Greasy stains	<ul style="list-style-type: none"> <li>- Increase the dose of washing product</li> <li>- Use a new packet of washing product</li> <li>- Choose a better adapted programme</li> </ul>
Limescale deposits on the dishes	<ul style="list-style-type: none"> <li>- Check it is limescale (clean with vinegar). If yes :</li> <li>- Check the hardness of the water</li> </ul>
The dishes are dull	<p>Too soft water is aggressive for glasses.</p> <ul style="list-style-type: none"> <li>- Check the hardness of the water</li> </ul>
Blackened or marked silverware	<ul style="list-style-type: none"> <li>- Remove food residue immediately after use</li> <li>- Separate silverware from other metals</li> <li>- Choose detergent recommended for silverware</li> </ul>
Traces of rust on knife blades	<ul style="list-style-type: none"> <li>- Use knives suitable for dishwashers</li> </ul>
The dishwasher does not empty	<ul style="list-style-type: none"> <li>- Check the drain pipe is not bent or crushed</li> <li>- If connected to the 'S' trap spigot under the adjacent sink, remove hose and check for blockages in the spigot.</li> </ul> <p>This machine complies with all applicable safety standards. Any repairs should be carried out by a qualified technician. Repairs carried out by unqualified technicians may be dangerous for the user.</p>

If you have problems not covered by these remarks, contact Kleenmaid Call Centre on phone 1 800 072 144.

# ILLUSTRATIONS

**1**

1. Work top
2. Upper basket
3. Washing detergent distributor
4. Self-cleaning microfilter
5. Rating plate
6. Lower spray arm
7. Main filter
8. Waste trap
9. Rinse aid distributor



The photograph above, with lower basket removed, shows you the main parts described in this instruction manual.

**2**

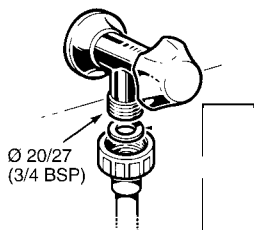

**3**

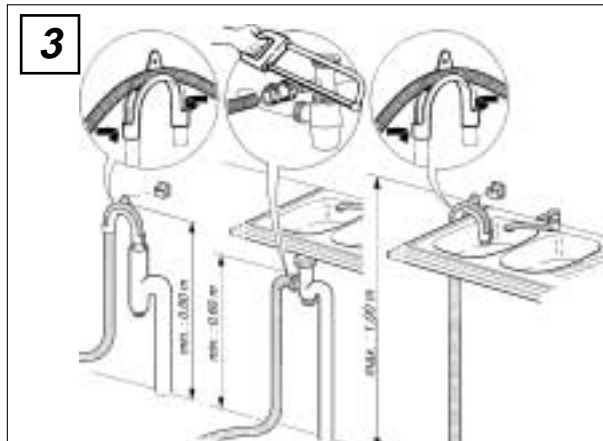

**4**

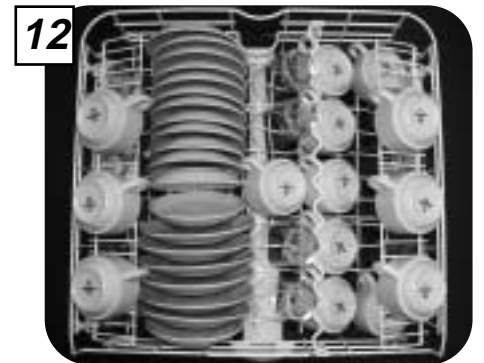
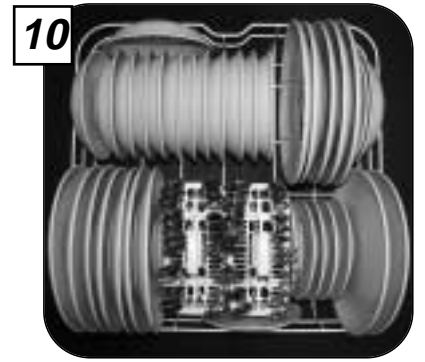
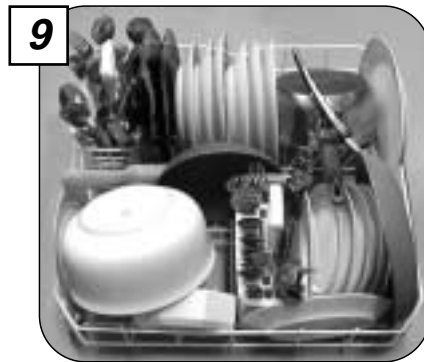
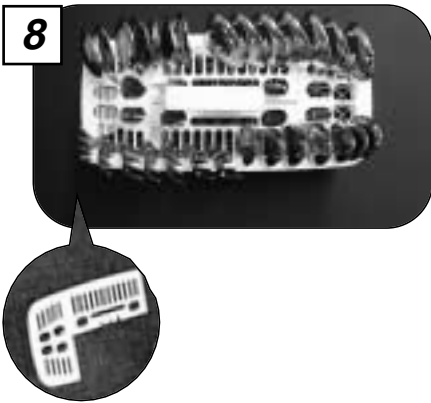
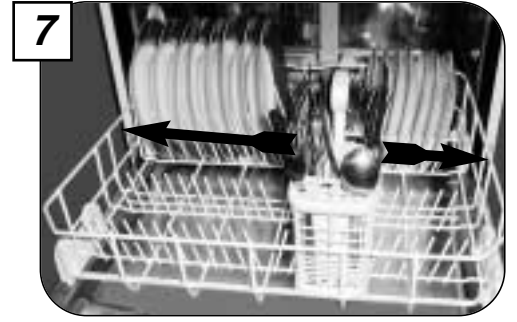
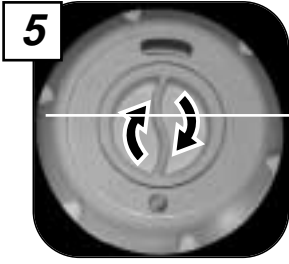



## WARRANTY AND SERVICE

### DOMESTIC WARRANTY - FULL FIVE YEAR WARRANTY

In addition to all statutory rights which you, the Consumer, have under the relevant laws in respect of this appliance, during the first five years of ownership as the original purchaser of this Kleenmaid appliance, we guarantee that any fault caused by faulty material or workmanship becoming apparent will be rectified free of charge for parts and labour, provided that all service is performed during normal working hours by Kleenmaid or their designated Agents. Where the appliance is installed outside the normal servicing area of the above, the Purchaser must pay for the cost of transporting the appliance to and from the Agent or the Agent's travelling cost to and from the Purchaser's home.

### COMMERCIAL WARRANTY - ONE YEAR WARRANTY

When this appliance is installed in a commercial application, you, the Consumer, have under the relevant laws in respect of this appliance, during your first one year of ownership as the original purchaser of the Kleenmaid appliance, we guarantee that any fault caused by faulty material or workmanship becoming apparent, will be rectified free of charge for parts and labour, provided that all service is performed during normal working hours by Kleenmaid or their designated Agents. Where the appliance is installed outside the normal servicing area of the above, the Purchaser must pay for the cost of transporting the appliance to and from the Agent or the Agent's travelling cost to and from the Purchaser's home.

### WHAT THESE WARRANTIES DO NOT COVER

We are not responsible for any damage or malfunction unless caused by a defect in material or workmanship. This includes but is not limited to abuse, misuse, improper installation and transportation damage. We are not responsible for any consequential damages from any malfunction.

### WARRANTY DOES NOT COVER REPLACEMENT OF LIGHT GLOBES OR GLASS BREAKAGE DUE TO IMPACT

In case of fractured glass do not use your appliance.

### WARRANTY REGISTRATION

Please complete the enclosed warranty card and retain this as a record of purchase.

### SERVICE ASSISTANCE

To assist you when phoning our After Sales Service number to arrange a service call please complete the following details and have them ready when you call.

Model Number : \_\_\_\_\_ Date of purchase : \_\_\_\_\_

Kleenmaid Store purchased from : \_\_\_\_\_ Date of installation : \_\_\_\_\_

**KLEENMAID AFTER SALES SERVICE  
CONTACT NUMBER  
1 300 652 100**

***Other products in Kleenmaid's  
range of world's best appliances :***

***Washers***

***Dryers***

***Dishwashers***

***Ovens***

***Cooktops***

***Rangehoods***

***Sinks***

***Waste Disposals***

***Taps***

***Cookware***

***Refrigerators***

***Freezers***

***Vacuum Cleaners***

***For sales informations on the full range of quality  
kitchen and laundry appliances, phone 13 13 08***