

DISHWASHER

c o l l e c t i o n



Instructions for Use and Warranty Details

Dishwashers DW16I





Congratulations on the purchase of your new Kleenmaid appliance. This appliance has been designed and manufactured to give you years of reliable performance. For best results, carefully read the instructions on how to install your new appliance. Correct installation will avoid delays and unnecessary service calls.

Once installation is complete, read this booklet and get to know the controls and the features of your new appliance.

If you need further information call our

After Sales Service

I 300 652 100.

We reserve the right to alter the specifications with no influence on the operation of the appliance. This instruction manual cannot be reason for claim.

CONTENTS

	Page
Safety advice	4
Installation	5-6
Adding rinse aid	6
Loading the dishwasher	7
Adding washing detergent	8
Choice of programmes	9
Glassware, Pots and Silverware	10
Cutlery, China and Woodware	10
Technical characteristics	11
Instructions for cleaning and maintenance	11
Troubleshooting	12
Illustrations 1 - 3	13
Illustrations 5 - 15	14-15
Warranty and Service	

**BEFORE READING THESE EXPLANATIONS, CONSULT THE ILLUSTRATIONS
ON THE PAGES 13-15 OF THIS INSTRUCTION MANUAL**

SAFETY ADVICE

Please read the instructions in this booklet carefully. You will find instructions necessary for security, installation and using your machine as well as the guarantees. We advise you to keep the booklet and pass it on if you sell the machine.

We cannot accept responsibility if the instructions below are not followed :

- Please destroy the packaging in an appropriate way and in compliance with environmental protection legislation.
 - If the machine is visibly damaged, do not connect it and contact your dealer.
 - It should be placed in a frost-free area. In case of frost, the hydraulic systems may be damaged.
 - The water supply and evacuation pipes must be connected according to instructions. Incorrect connections may cause damage.
 - To ensure proper stability, built-in machines should be installed below a continuous work surface fixed to the adjoining cabinets.
 - You should not stand or lean on the open dishwasher door. The machine could tip over or be damaged.
 - The machine is intended to wash dishes and should not be put to other uses.
 - Using solvents to clean or maintain your machine is highly unsuitable.
- You should store dishwasher products as well as other cleaning products out of the reach of children. These products have a corrosive effect on the mouth and pharynx if they are swallowed.
- If the machine malfunctions due to other causes than those mentioned in this booklet, disconnect the machine (remove the plug) or break the circuit concerned and contact our after-sales service.
 - The machine complies with applicable safety regulations. Any repairs should only be carried out by qualified technicians. Repairs or changes that do not conform may be dangerous for the user. In case of replacement, only use original parts.
 - Broken machines should be taken to the closest recycling centre. Destroy the door closing system so it no longer works (children may close themselves in whilst playing and suffocate). Cut the electric cable after having removed the plug from the socket.
 - You are strongly advised to disconnect the machine after use and turn off the water supply.
 - Do not let children play with the machine or touch it.
 - The water inside the machine is not suitable for drinking.
 - When the machine is running, do not open the door. This may provoke important steam leakage or splattering of water.

INSTALLATION

IMPORTANT ! :KLEENMAID RECOMMENDS THAT YOUR DISHWASHER BE INSTALLED BY AN AUTHORISED Kleenmaid INSTALLER OR SERVICE AGENT !!

Before you start :

- 1 . These instructions are intended as a guide only. It is the responsibility of the Plumber and Electrician to ensure that each installation complies with local by-laws.
- 2 . Connection to cold water is recommended.
- 3 . This Dishwasher must not be connected to a water supply where the temperature of the water exceeds 65 °C. If this Dishwasher is to be connected to a system where there is no temperature control, a temperature control valve, limiting the water temperature must be fitted.
- 4 . When installing the Dishwasher, check that the drain hose does not become restricted or kinked.

Levelling : Adjusting the feet :

Make sure that the machine is properly upright and stable. The four feet may be altered, adjust them if necessary using a wrench or a screwdriver. Badly adjusted feet may move the door off centre and make the machine unstable.

IMPORTANT : Do not connect the dishwasher to the power or water supply before completing installation.

If you are installing your dishwasher on carpet, adjust the feet so that you leave space for air to circulate underneath the machine.

Fitting your machine into your kitchen :

The building in sizes for the machine are given in the "technical characteristics" chapter on page 11.

Glue the steam protector supplied with your machine underneath your worktop.

To maintain stability and proper alignment, **you should attach** your machine to the work surface using a bracket.

Built-in appliance cup kit

(available according to the model from After-Sales or the dealers)

To assist in sliding your dishwasher (over rough or carpeted floors, etc.), clip the little cups to all four feet.

Fitting the door panel :

There are two ways of fitting the front of your machine :

- 1 - A cabinet door + false drawer
- 2 - A complete front panel

Consult page 10 of this manual for this operation and use the assembly template and accessories supplied with your machine.

Adjust the springs to set the door, see **Fig. 15**. You will find this easier with the door closed.

Important : This machine operates equipped with wood panels.

Plumbing :

1 . Water Connection

- This Kleenmaid "Super Silent System" Dishwasher can be connected to cold water or hot water not exceeding 65 °C.
- We recommend that the Dishwasher is connected to a cold water supply.

NOTE : Connection to a hot water supply will change the length of the wash cycles and can reduce the drying efficiency of the dishwasher.

2 . Water Supply (Fig. 2)

- a . The water supply to the Dishwasher should not be less than 12 mm domestic water pipe. A readily accessible tap must be installed in the supply pipe.
- b . The inlet connection hose supplied is fitted to a 3/4" BSP male thread, which must have an adequate sealing face for the washers supplied.
- c . If the Dishwasher is connected to a hot water supply, then the water temperature at the Dishwasher must never exceed 65 °C.
- d . The water supply pressure is to be between 21 kPa (4.0 psi) minimum and 970 kPa (140 psi) maximum.

If pressure is greater 100 psi, it is recommended to fit a pressure limiting valve to prevent damage from rises and increased pressure of peak demand.

INSTALLATION CONTINUED

Protection against water damage :

Your machine is equipped with systems that protect you from flooding.

- **Anti-overflowing mechanism.** This system activates the waste pump if the water level in the tub reaches an abnormal level.

Evacuating waste water (Fig. 3)

Connect the waste pipe

A. Either to the ventilated siphon. The waste pipe must be free in the siphon and should be no deeper than 20 cm.

B. Or on the sink siphon. Be careful not to forget to remove the siphon cover.

Be careful to fix the waste pipe down with a tie to avoid any flooding. In any case, the end of the pipe must be between 60 cm and 1 m high. Avoid folding the pipe when installing.

- Horizontal drain lines should not exceed 5 m length.
- Ensure that the drain hose is fully extended and not restricted in any way.

NOTE : Do not connect drain hose directly to a waste disposal unit as blocking with food waste will occur.

Connecting to the power supply :

You should use an earthed plug to connect to the power supply. In case of a direct connection, the main switch terminal should be at least 3 mm apart.

The electric plug should remain accessible. Do not use an extension lead or multiple plug.

- **We cannot be held responsible for any incident caused by the machine being badly earthed.**

In any case, the machine must be fitted in compliance with the applicable regulations in your state as well as any extra instructions from the Electricity Company. The machine's approval and model are indicated on the sticker fixed to the left-hand side of the door. The machine must be turned off when connecting to the electric circuit.

Replacing the electric lead

WARNING : In the interests of safety, the electrical supply lead should **ONLY** be replaced by the manufacturer's after-sales staff or a similarly qualified person.

ADDING RINSE AID

Rinse aid is necessary as it avoids stains on the dishes and makes drying easier.

IMPORTANT ! Only use products intended for dishes and NOT detergents intended for hand washing !

We recommend using Kleenmaid Dishwasher Rinse Aid. Please phone our After Sales Service on 13 13 08 for the Store nearest you.

Filling and adjusting the rinse aid container (Fig. 5-6) :

Put the door in a horizontal position when filling the container and unscrew the cap in the door counter clockwise.

Fill to just below the adjusting lever.

If the product overflows on filling, remove the excess with a sponge to avoid any foam forming.

If you experience stains or bad drying after several cycles, you may adjust the dosage using the selector :

Soft water : level 1 to reduce the dose

Hard water : level 3 to increase it.

Finding the level of the rinse aid :

A light on the control panel comes on when you need to add rinse aid.

For child safety :

Dishwashing detergent and rinse aid should be treated as poisons and stored where they are not accessible to children.

LOADING THE DISHWASHER

For best washing results, be careful before loading dishes to remove food residue. Any burned or stuck leftovers should be removed. Your dishwasher has two baskets for 14 place settings (162 pieces) according to AS 2007 (Fig. 10 and 12). Always turn the inside of the dishes towards the bottom. Be sure that no dish hides others and the spray jet is not obstructed. Check that the spray arm is free to rotate. No dish should be higher than the basket.

Lower basket (Fig. 7-9-10)

Place the dishes so that water may circulate freely and spray all the utensils. (Avoid attaching and piling dishes up).

This basket is especially intended to hold: plates, cutlery, dishes, frying pans, saucepans. Dishes and frying pans can be placed on the right-hand side or even in the front.

Avoid mixing plates and soup dishes. You should preferably place same-sized plates together. Place soup dishes at the back, in the high pin area.

Make sure nothing obstructs the rotation of the lifting arm (saucepan handles, cutlery or large dishes).

Collapsible racks on the front and back of the basket facilitate storing large recipients.

The cutlery baskets are sliding and can be placed in any area of the lower basket meaning that you can change the layout according to the type of dishes you are washing.

Removable grids are adaptable to cutlery baskets allowing you to arrange cutlery, especially small spoons, as you wish.

For optimum washing, you can use the separation grids.

Cutlery (Fig. 8)

- Place handles downwards.
- It is preferable to place small spoons in the separating grids.
- Avoid washing wooden, bone or hollow handled cutlery in the machine.
- Separate silverware from other metals using the separating grid.

note : For reasons of safety, we recommend you place sharp-ended table knives blade down in the cutlery basket.

Long-bladed cutlery and other sharp utensils should be placed flat in the upper basket.

Upper basket (Fig. 11-12)

This basket is particularly intended to hold glasses, cups, ramekins, small salad bowls, bowls, saucers etc...

Place glasses so that they do not touch and tip them sufficiently so that they do not retain any water. **Place the hollow end of glasses, cups and bowls facing downwards.** Arrange the dishes methodologically to gain space (rows of glass, cups, and bowls).

You can also stack cups, ladles, etc. on the racks. The foldaway spikes provide you with the possibility of a multi-purpose space to accommodate a varied load.

The upper basket should be adjusted to the HIGH position when loading large plates in the lower basket. The setting can be execute basket in charge.

 **Setting the HIGH POSITION**
Slowly lift the basket until you hear a **click** on each side.

 **Setting the LOW POSITION**
Lift the basket completely on both sides (**click**) and then follow it downwards.

Make sure that the two runners are adjusted to the same level.

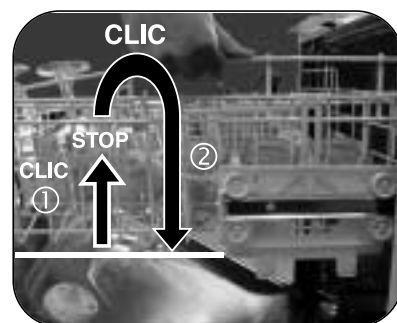

ADDING WASHING DETERGENT

The washing product container has been placed in front of the upper basket to make the machine easier to fill. This means that you can load the washing powder without bending down or completely opening the door. Use washing products specifically designed for dishwashers, either tablets, powder or liquid detergent.

We recommend using Kleenmaid Dishwasher Powder and Rinse Aid. Please phone 13 1308 for the Store nearest to you.

Before running a programme :

- Put the tablet in the outside compartment.

OR

- Pull the distributor out to fill with powder or liquid. Minimum and maximum levels are marked on the inside of the distributor and represent approximately 10-25 grams or 2-5 teaspoons. Amount required to be used for each load may vary according to the conditions such as dirtiness of the dishes, water hardness and detergent type. However in most cases 10 grams (2 teaspoons) of Kleenmaid St George Dishwashing Powder will be sufficient.
Close the distributor.

See the manufacturers' recommendations on the packet as well as the advice for use below.



tablet



powder or liquid

For child safety

Warning - Dishwasher detergents are strongly alkaline. They can be extremely dangerous if swallowed. Avoid contact with skin and eyes and keep children away from the dishwasher when the door is open.

Check that the detergent receptacle is empty after completion of the wash cycle !

CHOICE OF PROGRAMMES

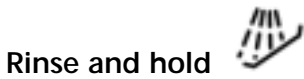

Rinse and hold

Very short cycle, without detergent, rinses dishes before washing the next day or the day after.

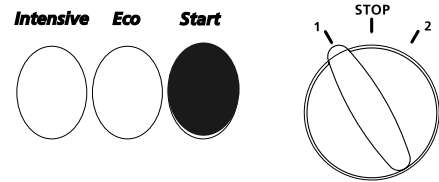

Normal Wash :

Recommended for normally dirty dishes (daily stains).

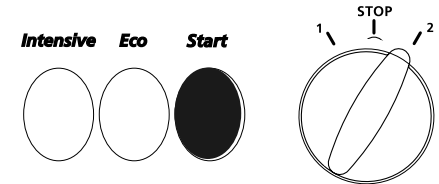

Intensive Wash :

Recommended for very dirty or greasy dishes (difficult stains : fat, sauce, cooking or frying stains...)

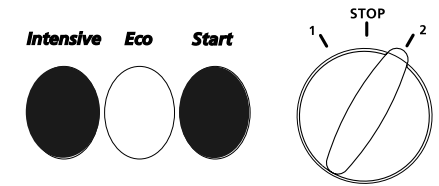

Economy Wash :

Recommended for dishes that are slightly dirty or greasy.

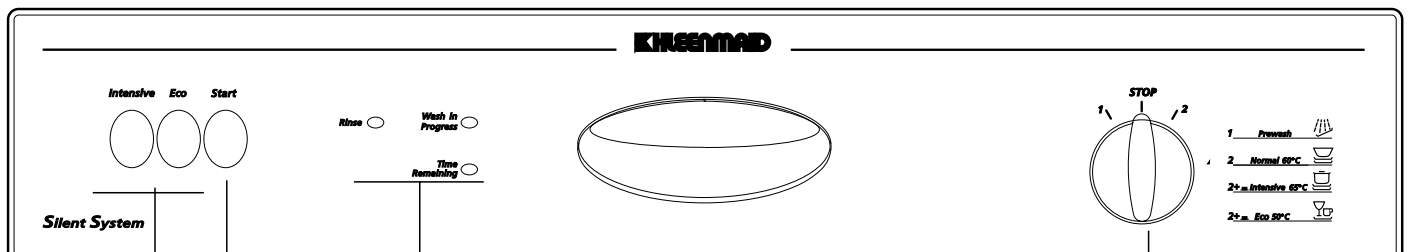
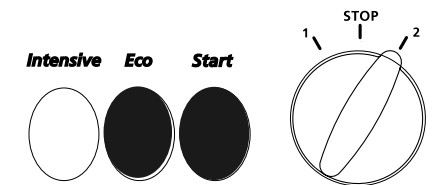

②

③

④

①

- ① Programme button
- ② Options button
- ③ Start button
- ④ Indicator lights :

- Rinse Aid Required - Refer Page 6
- Wash in Progress : means that the cycle timer is in progress.
- Time Remaining : means that 15 mins remain before the end of the cycle.

For information purposes : (according to drying)

	Duration	Water	Electricity
Rinse and Hold	5 mins	5 L	0.1 kWh
Normal Wash	80 mins	24 L	1.65 kWh
Intensive Wash	85 mins	24 L	1.75 kWh
Economy Wash	74 mins	24 L	1,47 kWh

GLASSWARE, POTS AND SILVERWARE

Glassware

Most glassware is dishwasher safe. We do not recommend washing crystal items in the dishwasher, as crystal is not dishwasher safe.

Pots and Saucepans

- Pots and saucepans can be washed in the dishwasher. Scrape off food scraps and put items in the baskets upside-down.
- Stainless steel can be washed in the dishwasher.
- As when hand washed, aluminium is dulled by being washed in the dishwasher.

Silverware

- All silverware should be rinsed immediately after use to prevent discolouration caused by some foods. The "Prewash" programme is useful for this situation.
- Old silverware and hollow handle knives with adhesives securing the handles should be washed by hand.

CUTLERY, CHINA AND WOODWARE

Cutlery

- Stainless steel and silver should not be allowed to come into contact with each other, as this can stain the silver.
- Remove sterling and silver plated cutlery from the dishwasher and hand dry it immediately after the programme has finished.
- Wooden, bone and plastic handles can be sensitive to higher water temperatures. The appearance of these items may change over time if washed in the dishwasher.

Decorated China and Tableware

- Most current china patterns are dishwasher safe. However, we advise checking with their manufacturer.
- Older items with the design over the glaze, ie. gold rims and hand-painted China may be more sensitive to machine washing. If in doubt, wash these items by hand.

Woodware

Generally wooden items are sensitive to heat and water.

Regular use in the dishwasher may alter their appearance. We suggest you wash wooden items by hand.

Remember, if in doubt about any aspect concerning materials washed in the dishwasher, follow manufacturer's instructions or wash the item by hand.

TROUBLESHOOTING

Problems	Causes
The dishwasher will not start	<ul style="list-style-type: none"> - Is it plugged in ? - Is the door properly closed ? - Is the water connected ? - Check that the delay button is not depressed.
The dishes are not properly washed	<ul style="list-style-type: none"> - Programme choice. Choose the programme best adapted to the type of wash - Make sure nothing is blocking the circulation of the water - Check the dishes are properly arranged. - Only use specially designed washing products - Check the waste well, filters, arms, joints and door rim are clean - Clean the filter - Check that the washing arm can freely rotate
Greasy stains	<ul style="list-style-type: none"> - Increase the dose of washing product - Use a new packet of washing product - Choose a better adapted programme
Limescale deposits on the dishes	<ul style="list-style-type: none"> - Check it is limescale (clean with vinegar). If yes : - Check the hardness of the water
The dishes are dull	<p>Too soft water is aggressive for glasses.</p> <ul style="list-style-type: none"> - Check the hardness of the water
Blackened or marked silverware	<ul style="list-style-type: none"> - Remove food residue immediately after use - Separate silverware from other metals - Choose detergent recommended for silverware
Traces of rust on knife blades	<ul style="list-style-type: none"> - Use knives suitable for dishwashers
The dishwasher does not empty	<ul style="list-style-type: none"> - Check the drain pipe is not bent or crushed - If connected to the 'S' trap spigot under the adjacent sink, remove hose and check for blockages in the spigot. <p>This machine complies with all applicable safety standards. Any repairs should be carried out by a qualified technician. Repairs carried out by unqualified technicians may be dangerous for the user.</p>

If you have problems not covered by these remarks, contact Kleenmaid After Sales Service on phone 1 300 652 100.

ILLUSTRATIONS

1

1. Upper basket
2. Washing detergent distributor
3. Self-cleaning microfilter
4. Rating plate
5. Main filter
6. Lower spray arm
7. Waste trap
8. Rinse aid distributor

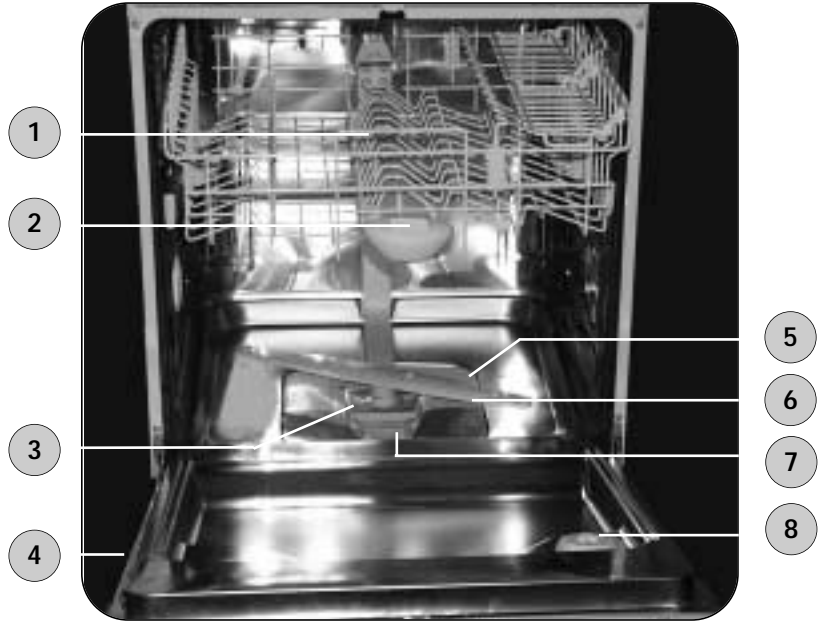

The photograph above, with lower basket removed, shows you the main parts described in this instruction manual.

2

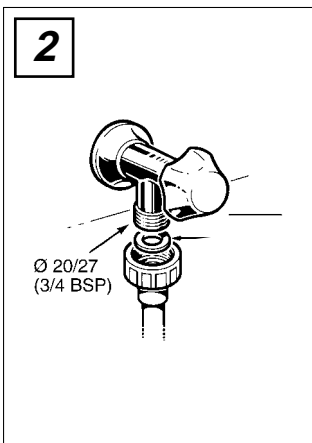

3

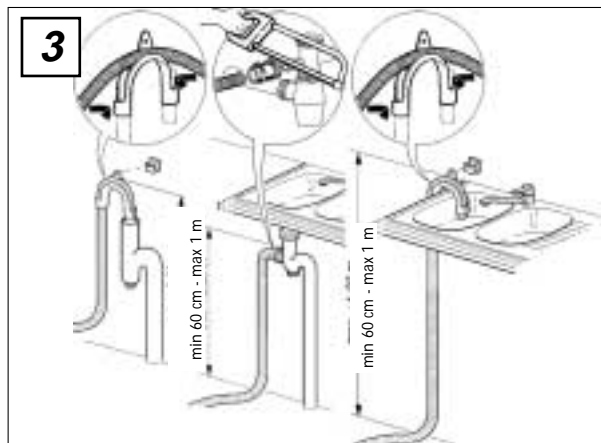

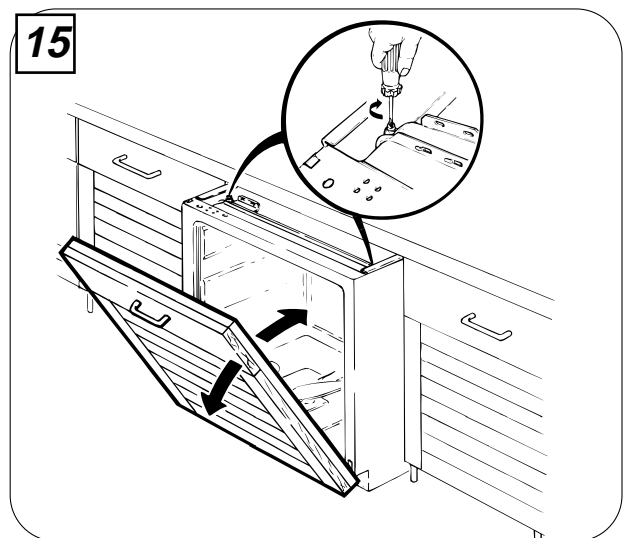
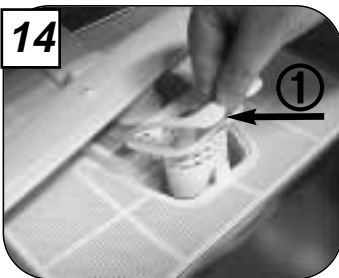
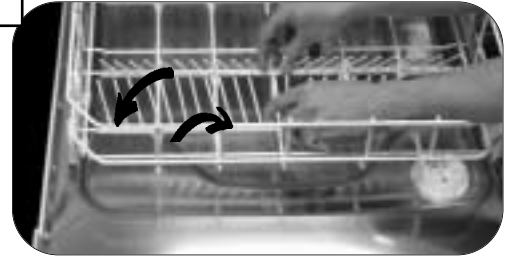
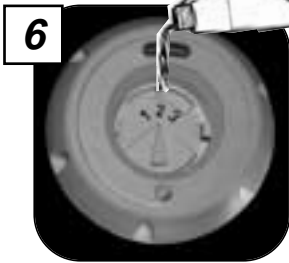
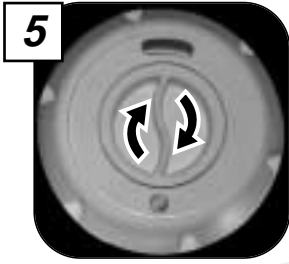

COMPARATIVE TESTS ACCORDING TO : AS/NZS 2007 : 98

Programme "Economy Wash" 

- Rinse aid dispenser setting on : 3
- Quantity of washing product : 40g
- For the determination of Drying Index the door of the dishwasher was opened approximately 240 mm at the end of the programme for 30 minutes.

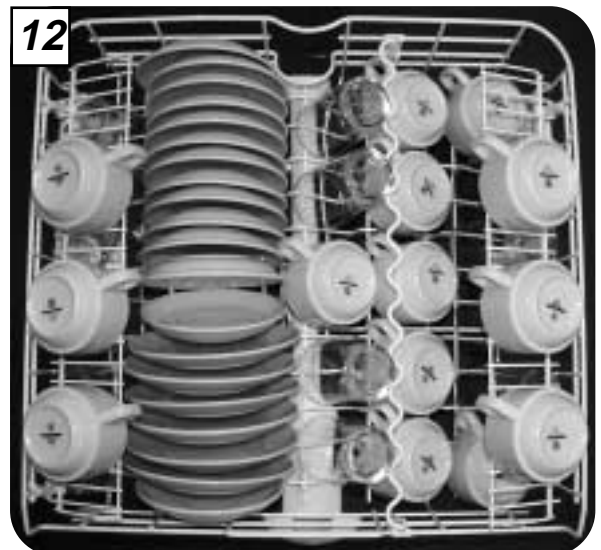
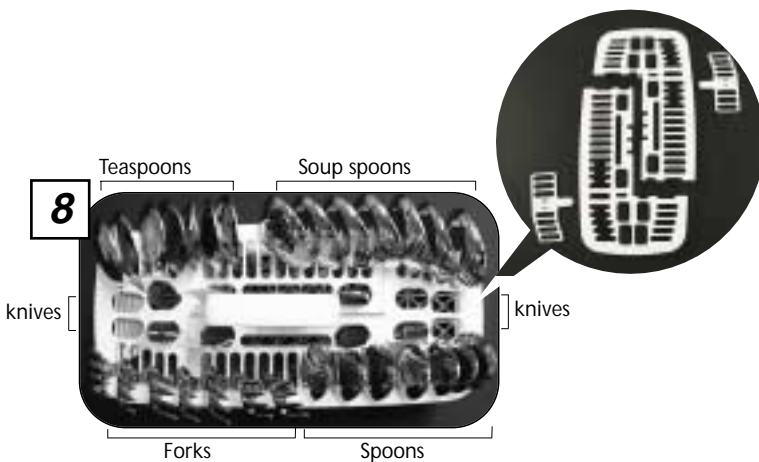
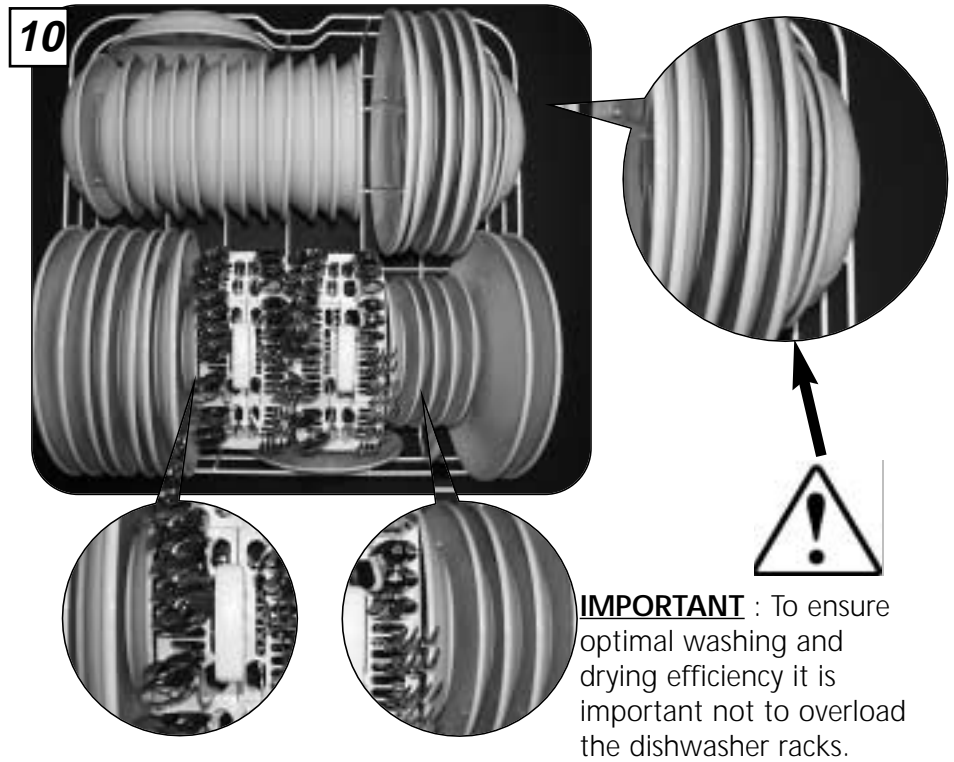

WARRANTY AND SERVICE

DOMESTIC WARRANTY - FULL FIVE YEAR WARRANTY

In addition to all statutory rights which you, the Consumer, have under the relevant laws in respect of this appliance, during the first five years of ownership as the original purchaser of this Kleenmaid appliance, we guarantee that any fault caused by faulty material or workmanship becoming apparent will be rectified free of charge for parts and labour, provided that all service is performed during normal working hours by Kleenmaid or their designated Agents. Where the appliance is installed outside the normal servicing area of the above, the Purchaser must pay for the cost of transporting the appliance to and from the Agent or the Agent's travelling cost to and from the Purchaser's home.

COMMERCIAL WARRANTY - ONE YEAR WARRANTY

When this appliance is installed in a commercial application, you, the Consumer, have under the relevant laws in respect of this appliance, during your first one year of ownership as the original purchaser of the Kleenmaid appliance, we guarantee that any fault caused by faulty material or workmanship becoming apparent, will be rectified free of charge for parts and labour, provided that all service is performed during normal working hours by Kleenmaid or their designated Agents. Where the appliance is installed outside the normal servicing area of the above, the Purchaser must pay for the cost of transporting the appliance to and from the Agent or the Agent's travelling cost to and from the Purchaser's home.

WHAT THESE WARRANTIES DO NOT COVER

We are not responsible for any damage or malfunction unless caused by a defect in material or workmanship. This includes but is not limited to abuse, misuse, improper installation and transportation damage. We are not responsible for any consequential damages from any malfunction.

WARRANTY DOES NOT COVER REPLACEMENT OF LIGHT GLOBES OR GLASS BREAKAGE DUE TO IMPACT

In case of fractured glass do not use your appliance.

WARRANTY REGISTRATION

Please complete the enclosed warranty card and retain this as a record of purchase.

SERVICE ASSISTANCE

To assist you when phoning our After Sales Service number to arrange a service call please complete the following details and have them ready when you call.

Model Number : _____ Date of purchase : _____

Kleenmaid Store purchased from : _____ Date of installation : _____

**KLEENMAID AFTER SALES SERVICE
CONTACT NUMBER
1 300 652 100**

***Other products in Kleenmaid's
range of world's best appliances :***

Washers

Dryers

Dishwashers

Ovens

Cooktops

Rangehoods

Sinks

Waste Disposals

Taps

Cookware

Refrigerators

Freezers

Vacuum Cleaners

***For sales informations on the full range of quality
kitchen and laundry appliances, phone 13 13 08***