

DISHWASHER

c o l l e c t i o n



Instructions for Use and Warranty Details

Dishwashers DW25 W - White

DW25 X - Stainless Steel

 **Kleenmaid**

Congratulations on the purchase of your new appliance. **T**his appliance has been designed and manufactured to give you years of reliable performance.

For best results, carefully read the instructions on how to install your new appliance. **C**orrect installation will avoid delays and unnecessary service calls.

Once installation is complete, read this booklet carefully and get to know the controls and the features of your new appliance.

We reserve the right to alter the specifications with no influence on the operation of the appliance. **T**his instruction manual cannot be reason for a claim.

CONTENTS

	Page
Safety advice	4
Installation	5-6
Adding rinse aid	6
Adjusting the water softener	7
Loading the dishwasher	8
Adding washing detergent	9
Choice of programmes	10
Meaning of the symbols	11
The safety systems	12
Options - Settings - information	13
Glassware, Pots and Silverware	14
Cutlery, China and Woodware	14
Installation	15
Technical characteristics	15
Instructions for cleaning and maintenance	16
Troubleshooting	17
Illustrations	18-19
Instructions for laboratory tests	20-21
Warranty and Service	

**BEFORE READING THESE EXPLANATIONS, CONSULT THE ILLUSTRATIONS
ON THE PAGES 18-19 OF THIS INSTRUCTION MANUAL**

SAFETY ADVICE

Please read the instructions in this booklet carefully. You will find instructions necessary for security, installation and using your machine as well as the guarantees. We advise you to keep the booklet and pass it on if you sell the machine.

We cannot accept responsibility if the instructions below are not followed :

- Please destroy the packaging in an appropriate way and in compliance with environmental protection legislation.
- If the machine is visibly damaged, do not connect it and contact your dealer.
- It should be placed in a frost-free area. In case of frost, the hydraulic systems may be damaged.
- The water supply and evacuation pipes must be connected according to instructions. Incorrect connections may cause damage.
- To ensure proper stability, built-in machines should be installed below a continuous work surface fixed to the adjoining cabinets.
- You should not stand or lean on the open dishwasher door. The machine could tip over or be damaged.
- The machine is intended to wash dishes and should not be put to other uses.
- Using solvents to clean or maintain your machine is highly unsuitable.

You should store dishwasher products as well as other cleaning products out of the reach of children. These products have a corrosive effect on the mouth and pharynx if they are swallowed.

- If the machine malfunctions due to other causes than those mentioned in this booklet, disconnect the machine (remove the plug) or break the circuit concerned and contact our after-sales service.
- The machine complies with applicable safety regulations. Any repairs should only be carried out by qualified technicians. Repairs or changes that do not conform may be dangerous for the user. In case of replacement, only use original parts.
- Broken machines should be taken to the closest recycling centre. Destroy the door closing system so it no longer works (children may close themselves in whilst playing and suffocate). Cut the electric cable after having removed the plug from the socket.
- You are strongly advised to disconnect the machine after use and turn off the water supply.
- Do not let children play with the machine or touch it.
- The water inside the machine is not suitable for drinking.
- When the machine is running, do not open the door. This may provoke steam leakage or splattering of water.

This appliance is not intended for use by young children or infirm persons unless they have been adequately supervised by a responsible person to ensure that they can use the appliance safely.

Dishwasher detergents are strongly alkaline. They can be extremely dangerous if swallowed. Avoid contact with the skin and eyes and keep children away from the dishwasher when the door is open. Check that the detergent receptacle is empty after completion of wash cycle

INSTALLATION

IMPORTANT ! :KLEENMAID RECOMMENDS THAT YOUR DISHWASHER BE INSTALLED BY AN AUTHORISED Kleenmaid INSTALLER OR SERVICE AGENT !!

Before you start :

- 1 . These instructions are intended as a guide only. It is the responsibility of the Plumber and Electrician to ensure that each installation complies with local by-laws.
- 2 . Connection to cold water is recommended.
- 3 . This Dishwasher must not be connected to a water supply where the temperature of the water exceeds 65 °C. If this Dishwasher is to be connected to a system where there is no temperature control, a temperature control valve, limiting the water temperature must be fitted.
- 4 . When installing the Dishwasher, check that the drain hose does not become restricted or kinked.

Levelling : Adjusting the feet :

Make sure that the machine is properly upright and stable. The four feet may be altered, adjust them if necessary using a wrench or a screwdriver. Badly adjusted feet may move the door off centre and make the machine unstable.

IMPORTANT : Do not connect the dishwasher to the power or water supply before completing installation.

If you are installing your dishwasher on carpet, adjust the feet so that you leave space for air to circulate underneath the machine.

Poor adjustment of the levelling feet can cause the dishwasher to leak.

Fitting your machine into your kitchen :

The building in sizes for the machine are given in the "technical characteristics" chapter on page 15.

Glue the steam protector supplied with your machine underneath your worktop.

To maintain stability and proper alignment, **you should attach** your machine to the work surface using a bracket.

Plumbing :

1 . Water Connection

- This Kleenmaid "Super Silent System" Dishwasher can be connected to cold water or hot water not exceeding 65 °C.
- We recommend that the Dishwasher is connected to a cold water supply.

NOTE : Connection to a hot water supply will change the length of the wash cycles and can reduce the drying efficiency of the dishwasher.

2 . Water Supply (Fig. 2)

- a . The water supply to the Dishwasher should not be less than 12 mm domestic water pipe. A readily accessible tap must be installed in the supply pipe.
- b . The inlet connection hose supplied is fitted to a 3/4" BSP male thread, which must have an adequate sealing face for the washers supplied.
- c . If the Dishwasher is connected to a hot water supply, then the water temperature at the Dishwasher must never exceed 65 °C.
- d . The water supply pressure is to be between 0.2 MPa (3.0 psi) minimum and 0.7 MPa (100 psi) maximum.

If pressure is greater 100 psi, it is recommended to fit a pressure limiting valve to prevent damage from rises and increased pressure of peak demand.

INSTALLATION CONTINUED

Protection against water damage :

Your machine is equipped with systems that protect you from flooding.

- **Anti-overflowing mechanism.** This system activates the waste pump if the water level in the tub reaches an abnormal level.
- **Anti-leakage device.** This system interrupts the water supply if a leak is detected underneath the machine.

If one of these mechanisms is started, contact the after-sales service to put it back into working order.

Your machine is equipped with a anti-bursting pipe.

Evacuating waste water (Fig. 3)

Connect the waste pipe

- A. Either to the ventilated siphon. The waste pipe must be free in the siphon and should be no deeper than 20 cm.
- B. Or on the sink siphon. Be careful not to forget to remove the siphon cover.

Be careful to fix the waste pipe down with a tie to avoid any flooding. In any case, the end of the pipe must be between 60 cm and 1 m high. Avoid folding the pipe when installing.

- Horizontal drain lines should not exceed 5 m length.

- Ensure that the drain hose is fully extended and not restricted in any way.

NOTE : Do not connect drain hose directly to a waste disposal unit as blocking with food waste will occur.

Connecting to the power supply :

You should use an earthed plug to connect to the power supply. In case of a direct connection, the main switch terminal should be at least 3 mm apart.

The electric plug should remain accessible. Do not use an extension lead or multiple plug.

• **We cannot be held responsible for any incident caused by the machine being badly earthed.**

In any case, the machine must be fitted in compliance with the applicable regulations in your state as well as any extra instructions from the Electricity Company. The machine's approval and model are indicated on the sticker fixed to the left-hand side of the door. The machine must be turned off when connecting to the electric circuit.

Replacing the electric lead

WARNING : In the interests of safety, the electrical supply lead should **ONLY** be replaced by the manufacturer's after-sales staff or a similarly qualified person.

ADDING RINSE AID

Rinse aid is necessary as it avoids stains on the dishes and makes drying easier.

IMPORTANT ! Only use products intended for dishes and NOT detergents intended for hand washing !

Filling and adjusting the rinse aid container (Fig. 5-6) :

Put the door in a horizontal position when filling the container and unscrew the cap in the door counter clockwise.

Fill to just below the adjusting lever.

If the product overflows on filling, remove the excess with a sponge to avoid any foam forming.

If you experience stains or bad drying after several cycles, you may adjust the dosage using the selector :

Soft water : level 1 to reduce the dose

Hard water : level 3 to increase it.

For child safety :

Dishwashing detergent and rinse aid should be treated as poisons and stored where they are not accessible to children.

ADJUSTING THE WATER SOFTENER

The water softener must be adjusted correctly to ensure no streaks after washing and drying. Your dishwasher is fitted with a water softening system that operates using regenerating salt. You must set the water softener according to the hardness of the water in your area.

① - Measuring the water hardness

To do this: contact your local water supplier to find out the water hardness level

OR measure the water hardness at the tap using the "Aqua-test" testing strip supplied with your dishwasher and refer to the table below to find out the setting to select according to the water hardness.

② - Setting on the control panel

Testing strip	Water hardness	Salt required	Water softener setting
	0 - 10°F	NO	C0 Ca
	10 - 18°F	YES	C1 Ca
	18 - 25°F	YES	C1 Ca
	25 - 40°F	YES	C2 Ca
	40 - 55°F	YES	C3 Ca
	55 - 70°F	YES	C4 Ca
	> 70°F	YES	C5 Ca

Hold down the "Heavy wash" button and turn the Programmes knob: the display then shows the water softener setting.

The display shows the water hardness according to the table above.

To change the setting, turn the Programmes knob while holding down the "Heavy wash" button.

When the machine is first switched on, the setting is 10°F>25°F (displayed as C1 Ca).

You must fill the salt reservoir with water before using the machine, even if the water softener setting selected does not require any regenerating salt.

If you move house and take the dishwasher with you, you will need to check the water hardness and adjust accordingly.

For good wash results it is very important to set the dishwasher to the correct level of water hardness and to set the correct level of rinse aid (see page 6)

③ Filling the regenerating salt reservoir

You must fill this, with water just before starting your first wash then add the salt:

Filling with salt is essential to obtain a **good wash with no streaks**. The salt regenerates the resins, which soften the water by removing its limestone content unless the water is already sufficiently soft (see "Adjusting the water softener").

Salt reservoir



Never put detergent in this reservoir: this will ruin the water softener.



- Unscrew the salt reservoir's stopper and remove it.
- Use the funnel to introduce the salt. available from the after-sales department under reference : 31X3964.
- Fill the reservoir with **regenerating salt** specially designed for dishwashers.
- **On the first time, add water until it reaches the edge of the reservoir.**
- Screw the salt reservoir's stop back in fully.

Do not use kitchen salt.

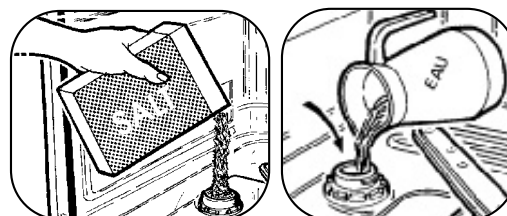

Should any regenerating salt overflow when filling, we recommend that you remove the loose salt crystals to avoid oxidising the tub.

LOADING THE DISHWASHER

For best washing results, be careful before loading dishes to remove food residue. Any burned or stuck leftovers should be removed.

Your dishwasher has two baskets for 12 place settings (132 pieces) according to AS 2007 (Fig. A-B-C see page 20). Always turn the inside of the dishes towards the bottom. Be sure that no dish hides others and the spray jet is not obstructed. Check that the spray arm is free to rotate.

Lower basket (Fig. 7-9-10)

Place the dishes so that water may circulate freely and spray all the utensils. (Avoid attaching and piling dishes up).

This basket is especially intended to hold: plates, cutlery, dishes, frying pans, saucepans. Dishes and frying pans can be placed on the right-hand side or even in the front.

Avoid mixing plates and soup dishes. You should preferably place same-sized plates together. Place soup dishes at the back, in the high pin area.

Make sure nothing obstructs the rotation of the lifting arm (saucepan handles, cutlery or large dishes).

Collapsible racks on the front and back of the basket facilitate storing large recipients.

The cutlery baskets are sliding and can be placed in any area of the lower basket meaning that you can change the layout according to the type of dishes you are washing.

Removable grids are adaptable to cutlery baskets allowing you to arrange cutlery, especially small spoons, as you wish.

For optimum washing, you can use the separation grids.

Cutlery (Fig. 8)

- Place handles downwards.
- It is preferable to place small spoons in the separating grids.
- Avoid washing wooden, bone or hollow handled cutlery in the machine.
- Separate silverware from other metals using the separating grid.
- Dropping knives point first will cause damage to the basket and will not be covered under warranty.

Important note : For reasons of safety, we recommend you place sharp-ended table knives

blade down in the cutlery basket.

Long-bladed cutlery and other sharp utensils should be placed flat in the upper basket.

Upper basket (Fig. 10-11)

This basket is particularly intended to hold glasses, cups, ramekins, small salad bowls, bowls, saucers etc...

Place glasses so that they do not touch and tip them sufficiently so that they do not retain any water. **Place the hollow end of glasses, cups and bowls facing downwards.** Arrange the dishes methodically to gain space (rows of glass, cups, and bowls).

You can also stack cups, ladles, etc. on the racks.

You can place a cutlery basket in the upper basket.

If your cutlery or your plates are too large, adjust the height of the upper basket

The **"Mezzanine"** (Fig. 12) wire shelf enables you to load cutlery of any size. You can place it either in the upper or lower basket.

The upper basket should be adjusted to the HIGH position when loading large plates in the lower basket.



Setting the HIGH POSITION

Slowly lift the basket until you hear a **click** on each side.



Setting the LOW POSITION

Lift the basket completely on both sides (**click**) and then follow it downwards.

Make sure that the two runners are adjusted to the same level.

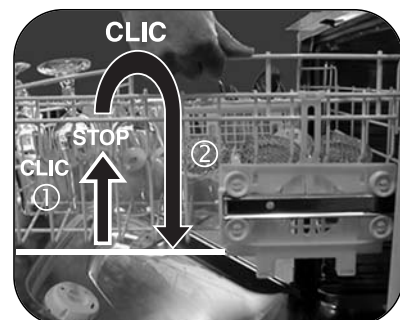

ADDING WASHING DETERGENT

The washing product dispenser has been placed in front of the upper basket to make the machine easier to fill. This means that you can load the washing powder without bending down or completely opening the door. Use washing products specifically designed for dishwashers, either tablets, powder or liquid detergent.

We recommend using the Finish range of Dishwasher detergents.

Before running a programme :

- Put the tablet in the outside compartment. Using tablets is particularly recommended for the Eco programme and for full loads of dishes.

OR

- Pull the dispenser out to fill with powder, liquid or tablet. Minimum and maximum levels are marked on the inside of the dispenser and represent approximately 5-25 grams or 2-5 teaspoons. Amount required to be used for each load may vary according to the conditions such as dirtiness of the dishes, water hardness and detergent type. Close the dispenser.

See the manufacturers' recommendations on the packet as well as the advice for use below.



tablet



powder or liquid

For child safety

Warning - Dishwasher detergents are strongly alkaline. They can be extremely dangerous if swallowed. Avoid contact with skin and eyes and keep children away from the dishwasher when the door is open.

Check that the detergent dispenser is empty after completion of the wash cycle !

CHOICE OF PROGRAMMES

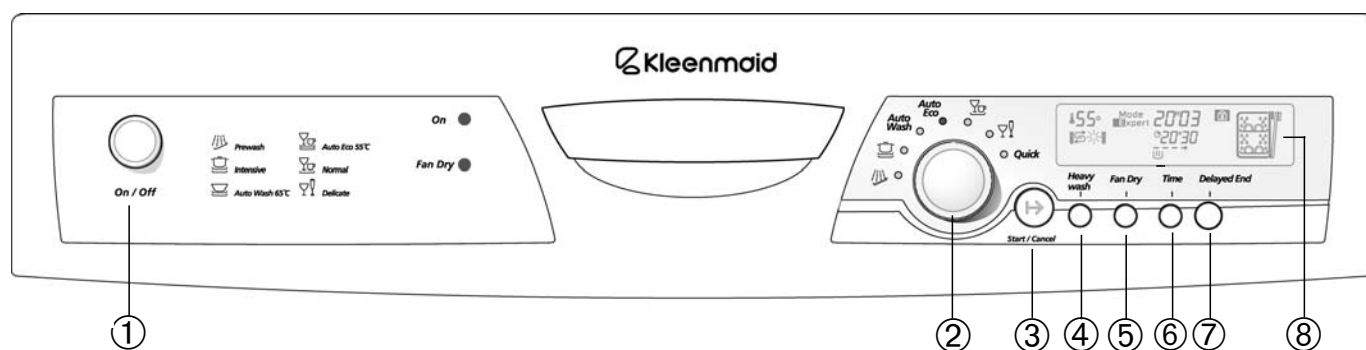

Your dishwasher has been specially designed to make life easy for you with a simplified range of programmes adapted to the most delicate china to the dirtiest pans.

- | | |
|-------------------------|---|
| ① ON/OFF BUTTON | Press this button to power your machine. |
| ② PROGRAMMES BUTTON | Turn this knob to choose your programme. |
| ③ START / CANCEL BUTTON | Press this button to start or cancel the programme. |
| ④ HEAVY WASH | Press this button for "Special Pots" programme. |
| ⑤ FAN DRY | Press this button for prolonged fan drying. |
| ⑥ TIME | Press the "Time" button and turn the "Delayed End" knob to select the current time. |
| ⑦ DELAYED END | Turn the "Delayed end" knob to select the time for the programme to finish |
| ⑧ DISPLAY | A display providing information and for viewing the programme. |



Prewash

This very short cycle, used without detergent, rinses dishes waiting to be washed the next day or the day after.



Intensive

Recommended for very dirty dishes with large quantities of dry or resistant stains : fat, sauce, cooking and frying stains. Every day and cooking dishes.

Auto wash 60°C

An automatic programme adapted to the quantity of items and any amount of residue. Your dishwasher optimises the results by **prioritising the length of the programme.**

Auto eco 50°C

An automatic programme adapted to the quantity of items and any amount of residue. Your dishwasher optimises the results by **prioritising the power consumption.**



Normal 45°C

Recommended for normal soiled load. Less consuming in energy.



Delicate 45°C

A gentle programme perfect for fragile, delicate glassware and dishes with a small degree of resistance to stains. Is also suitable for china that does not resist high temperatures.

Quick 40°C

A rapid wash programme recommended for slightly dirty, non greasy but fragile dishes.

Heavy wash "Special Pots programme": to select this specific programme, press the button and **"Start / Cancel"**. This programme cancels any other programme selected.

Advantages: this programme enables you to clean pots and plates with dried-on, sticky residue perfectly by washing them under high pressure with a cross-jet spraying system.

For information purposes :

	Duration	Water	Electricity
 Normal	100 mins	15L	0.58 kWh

These values refer to normal conditions of use. They may vary depending on the load, the temperature, the hardness of the water or the supply voltage.

MEANING OF THE SYMBOLS

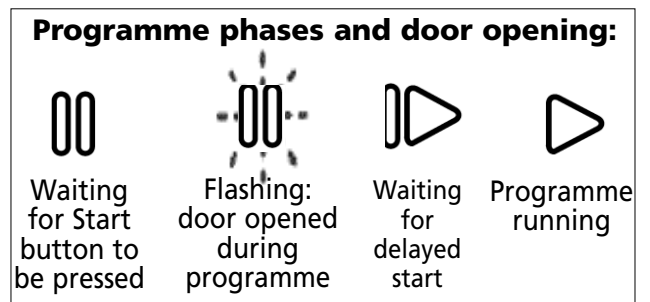
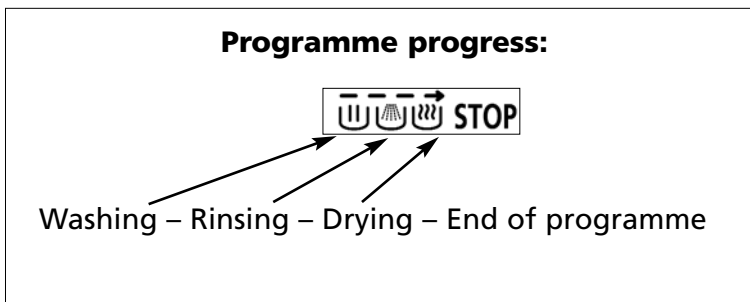
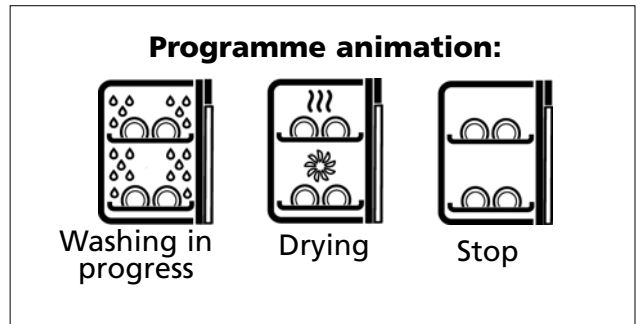
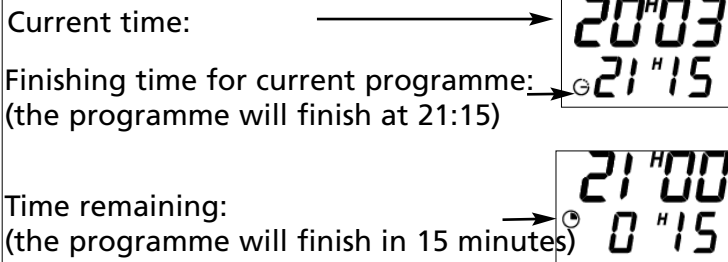
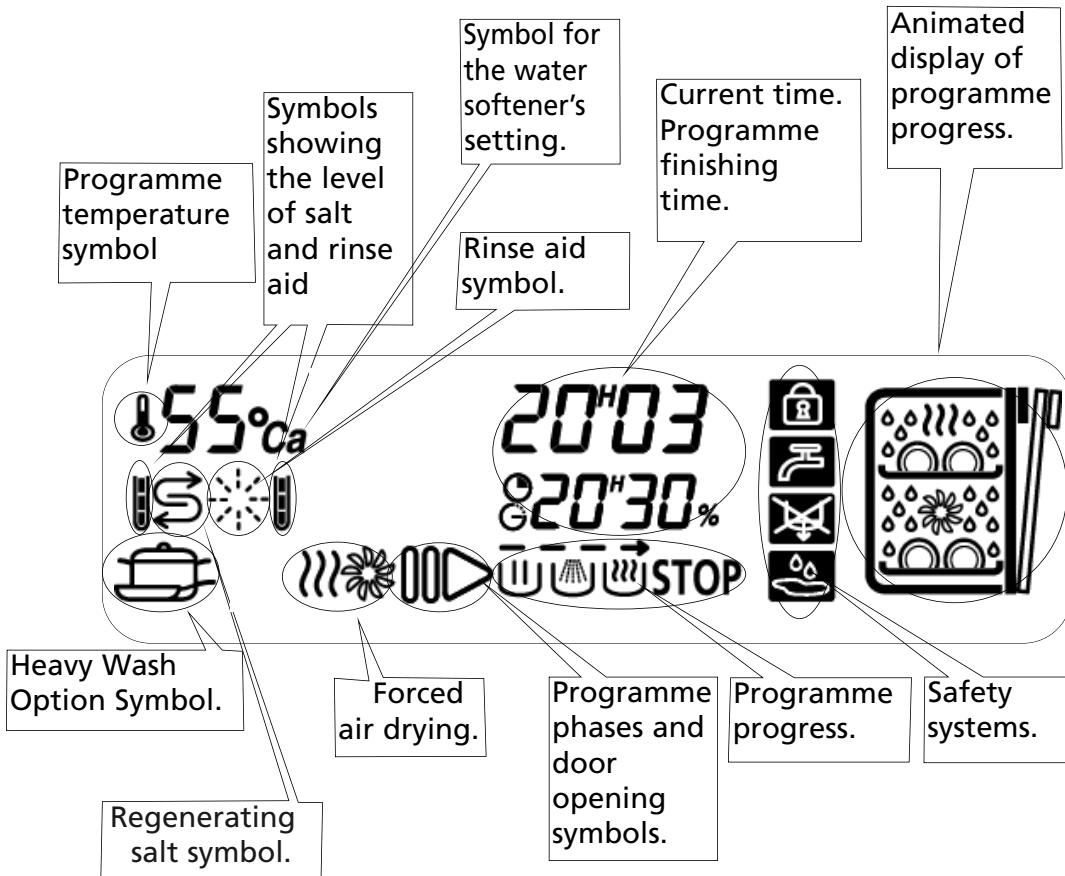

THE SAFETY SYSTEMS

Door poorly closed:

The light for the selected programme and the Door Open symbol both flash.

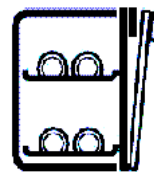

Keypad locking:

While the programme is running, the keypad is automatically protected against any activities. It unlocks automatically when the programme finishes or if it is cancelled.



Regenerating salt



Filling level:

Full Almost full Almost empty Empty (symbol flashing)

Rinse aid



Safety systems

The water tap is closed.

The drain or the drain hose is blocked.

Anti-leak system: intervention by the After-Sales Service required!



Filter cleaning warning

Approximately once a month, your machine will advise you to service the filters (see page 16).

F I L T

Setting your dishwasher

Setting the time:

When the machine is first switched on, the current time is shown as 0:00. Hold down the **"Time"** button and turn the **"Delayed End"** knob to the time desired.

Selecting a washing programme

Consult the Programmes table on Page 10, to determine the programme you need for the type of items, the quantity and the amount of food residue.

Press the **"On / Off"** button to switch the machine on.

Turn the Programmes knob; your selection is shown by the indicator light that is lit.

Press the **"Heavy Wash"** button for special pot programme.

Press **"Start / Cancel"**. The display shows the programme. Please refer to the previous pages for more details.

The last programme used is retained in memory.

Immediate start, programme's progress

Note: The machine automatically selects your most frequently used programme when turned on.

Select your programme and press **"Start / Cancel"**. The programme starts and the display shows you the programme's various phases until it reaches **"STOP"**.

Selecting a delayed programme end:

Turn the **"Delayed End"** knob to the time you wish the programme to finish.

Press **"Start / Cancel"** to confirm your programme.

Once the programme has started, the display shows the time the programme will finish.

Cancelling the programme

Hold down the Start button for 2 seconds; the programme light goes out and you can then re-programme.

Cutting off the regenerating salt and the rinse aid

If the water is especially soft and does not require the use of any regenerating salt or if you use "2 in 1" or "3 in 1" products, you can cancel the display of the salt and rinse symbols: press the "Fan dry" button and turn the programme knob. Repeat the operation if you wish to reactivate this function.

Checking the water softener setting

Press the **"Heavy Wash"** button and turn the Programmes knob one notch.

To change the setting, turn the Programmes knob while holding down the **"Heavy Wash"** button.

Fan drying

Your machine is factory set with the fan-drying system running for at least 5 hours.

If you press the **"Fan drying"** button, the fan system is reactivated for 5 minutes every hour until the door is opened.

Your washing-up and your machine interior will be perfectly dry.

Ensure that you do not leave anything in front of the door (bags, cloths), which could block the ventilation grill.

Economical and ecological washing

Do not prewash you dishes by hand.

Use your dishwasher to the full. Washing will be economical and environmentally friendly.

Always choose the programme best adapted to the type of dishes and according to the degree of dirt.

Avoid overdosing detergents and rinsing liquid. Observe the recommendations in this manual (pages 6-7-9) as well as the instructions on the product packaging.

GLASSWARE, POTS AND SILVERWARE

Glassware

Most glassware is dishwasher safe. We do not recommend washing crystal items in the dishwasher, as crystal is not dishwasher safe.

Pots and Saucepans

- Pots and saucepans can be washed in the dishwasher. Scrape off food scraps and put items in the baskets upside-down.
- Stainless steel can be washed in the dishwasher.
- As when hand washed, aluminium is dulled by being washed in the dishwasher.

Silverware

- All silverware should be rinsed immediately after use to prevent discolouration caused by some foods. The "Prewash" programme is useful for this situation.
- Old silverware and hollow handle knives with adhesives securing the handles should be washed by hand.

CUTLERY, CHINA AND WOODWARE

Cutlery

- Stainless steel and silver should not be allowed to come into contact with each other, as this can stain the silver.
- Remove sterling and silver plated cutlery from the dishwasher and hand dry it immediately after the programme has finished.
- Wooden, bone and plastic handles can be sensitive to higher water temperatures. The appearance of these items may change over time if washed in the dishwasher.

Decorated China and Tableware

- Most current china patterns are dishwasher safe. However, we advise checking with the manufacturer.
- Older items with the design over the glaze, ie. gold rims and hand-painted China may be more sensitive to machine washing. If in doubt, wash these items by hand.

Woodware

Generally wooden items are sensitive to heat and water. Regular use in the dishwasher may alter their appearance. We suggest you wash wooden items by hand.

Remember, if in doubt about any aspect concerning materials washed in the dishwasher, follow manufacturer's instructions or wash the item by hand.

INSTALLATION

Building the free-standing machine in

If you install the dishwasher built-in under an existing worktop, **you must attach it with the front bracket to a fixed worktop**. If installing in this way, proceed as follows:

- Remove the worktop by unscrewing the 2 screws under the edge of the upper plate.
- Fit the dishwasher into its housing.
- Adjust the height of the feet if necessary (fig. 4).
- Use two screws to fasten the front bracket to the kitchen worktop, so as to make your dishwasher fast.

For safety reasons Kleenmaid recommends that your dishwasher is not installed directly below a cooktop. If installation is carried out in this manner your warranty may be void.

NOTE : These measurements are shown without worktop fitted. If installing with worktop fitted :

- 1 - To overall height add 32mm
- 2 - To overall width add 4mm
- 3 - Overall depth of worktop from rear to front corners = 581mm
- 4 - Overall depth of worktop from rear to centre front 600mm

**Soundproofing apron (Fig 15)
See page 18**

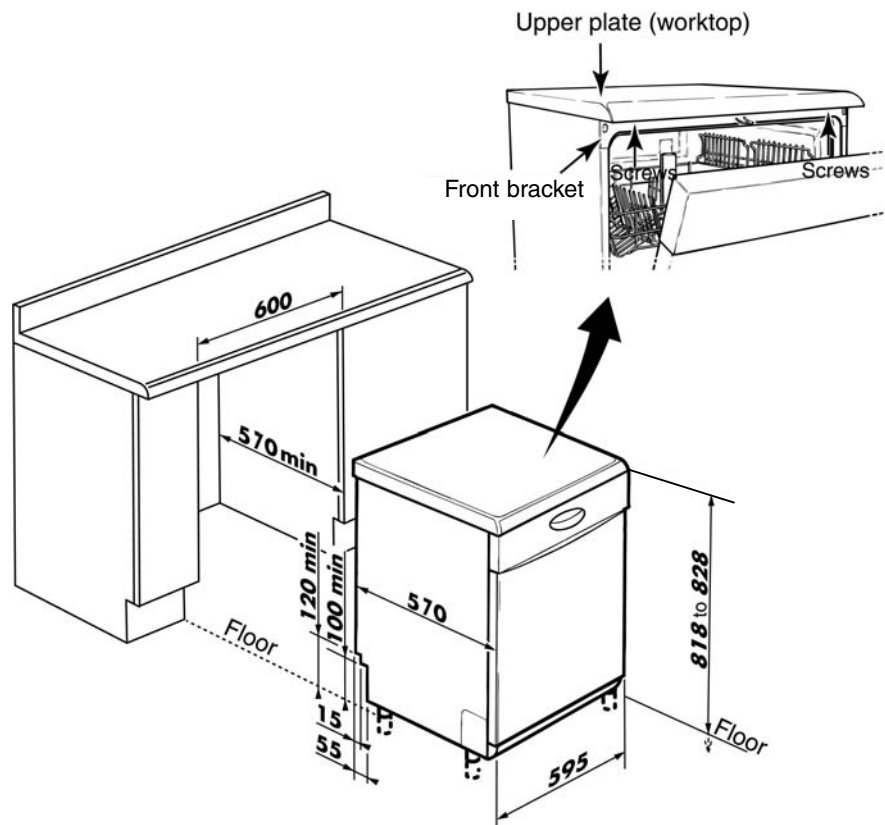

TECHNICAL CHARACTERISTICS

Voltage : 230-240 V – 50 Hz – Fuses : 10 A
Power : 2150-2300 W
Capacity : 12 place settings

Water pressure : 3 psi/0.2MPa min
100 psi/0.7 MPa max
Water evacuation pipe height : 60 cm - 1 m
Connection to cold water is recommended.
The dishwasher can use hot water pipe up to 65°C.

INSTRUCTIONS FOR CLEANING AND MAINTENANCE

Cleaning the waste filters

The filtration system consists of several components:

A – The two-part waste filter

B – The main filter

C – The micro-filter

- ① Before removing the filters, remove any waste from the main filter with a sponge to avoid the waste blocking the sprinkling arms.
- ② Unscrew the waste filter a quarter turn and remove it.
- ③ Remove the main filter
- ④ Remove the micro-filter.

A - Two-part waste filters.

- ⑤ Carefully clean all the filters under running water.

To re-insert the filters

Follow the above instructions in reverse.

 **Important: Do not forget to lock the waste filter by turning it a quarter turn.**

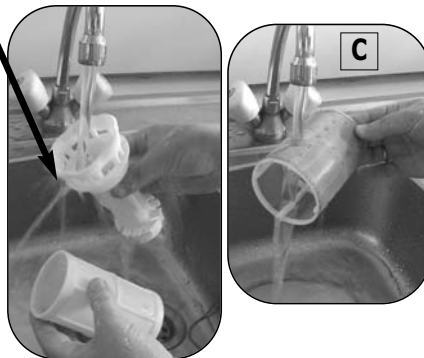

The filters are located in the middle of the tub and must be cleaned regularly to ensure optimum washing results.

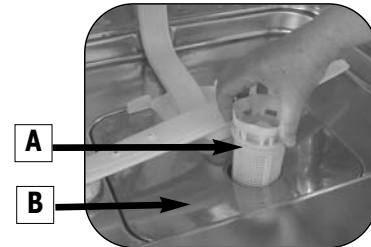

Clean as necessary

- Underneath the filters, around the door and the door joint with a damp sponge to remove any deposit.
- Use only soap and water for the body and control panel.
- Do not clean with abrasive powders, scouring pads, spirit-based products or solvents. Preferably use a cloth or a sponge.
- If you have a stainless steel door you may use products adapted for stainless steel. See the manufacturer's instructions for advice on their use.

We recommend using CSSPP - Stainless Steel Liquid Pump cleaner. Please contact our After Sales Service on 1300 652 100 or your nearest store on 13 13 08.

Every year

To maintain your machine in perfect working order you should clean it once or twice a year. Run on "Heavy Wash" programme with the machine empty and a special dishwasher cleaning product available from any reputable dealer.

Prolonged period of non-use

Clean your machine completely then unplug the electricity supply and close the water tap.

TROUBLESHOOTING

Problems	Causes
The dishwasher will not start	<ul style="list-style-type: none"> - Is it plugged in ? - Is the door properly closed ? - Is the water connected ? - Check that the delay button is not depressed
The dishes are not properly washed	<ul style="list-style-type: none"> - Programme choice. Choose the programme best adapted to the type of wash - Make sure nothing is blocking the circulation of the water - Check the dishes are properly arranged. - Only use specially designed washing products - Check the waste well, filters, arms, joints and door rim are clean - Clean the filter - Check that the washing arm can freely rotate - Check the amount of dishwasher detergent being used and adjust to recommended dose. See page 9.
Greasy stains	<ul style="list-style-type: none"> - Increase the dose of washing product - Use a new packet of washing product - Choose a better adapted programme
Limescale deposits on the dishes	<ul style="list-style-type: none"> - Check it is limescale (clean with vinegar). If yes : - Check the hardness of the water
The dishes are dull	<ul style="list-style-type: none"> - Too soft water is aggressive for glasses. - Check the hardness of the water
Blackened or marked silverware	<ul style="list-style-type: none"> - Remove food residue immediately after use - Separate silverware from other metals - Choose detergent recommended for silverware
Traces of rust on knife blades	<ul style="list-style-type: none"> - Use knives suitable for dishwashers
The dishwasher does not empty	<ul style="list-style-type: none"> - Check the drain pipe is not bent or crushed - If connected to the 'S' trap spigot under the adjacent sink, remove hose and check for blockages in the spigot.
The salt light remains lit	<ul style="list-style-type: none"> - If the water is especially soft and does not require the use of any regenerating salt. <p>This machine complies with all applicable safety standards. Any repairs should be carried out by a qualified technician. Repairs carried out by unqualified technicians may be dangerous for the user.</p>

If you have problems not covered by these remarks, contact Kleenmaid After Sales Service on phone 1 300 652 100.

ILLUSTRATIONS

1

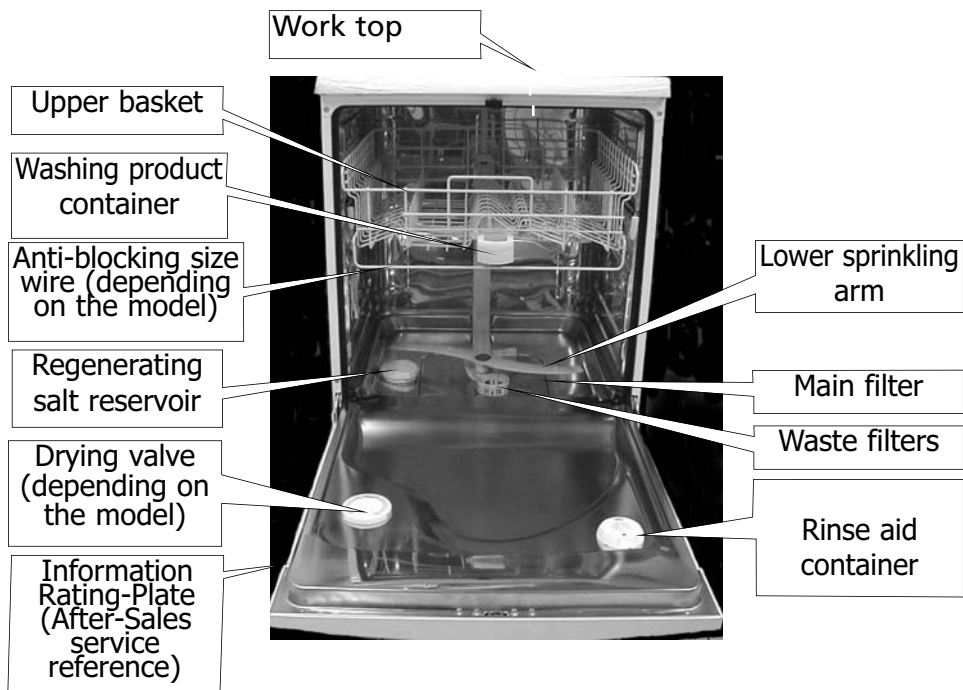

The photograph above, with lower basket removed, shows you the main parts described in this instruction manual.

Soundproofing apron

For optimum soundproofing, make sure the apron delivered with the machine is correctly installed. Having adjusted the feet for height :

- ① - Tilt the dish-washer backwards slightly so as to clip the apron onto the bottom of the plinth. Make sure it is correctly clipped at both ends and the centre.
- ② - Adjust the height of the apron; snip the end with a pair of scissors and cut one or more strips off it by hand. The apron should touch the floor.

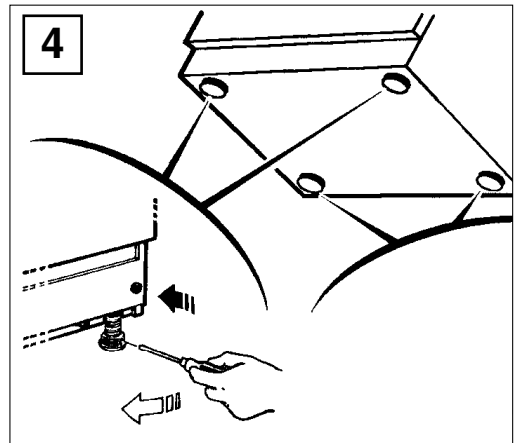
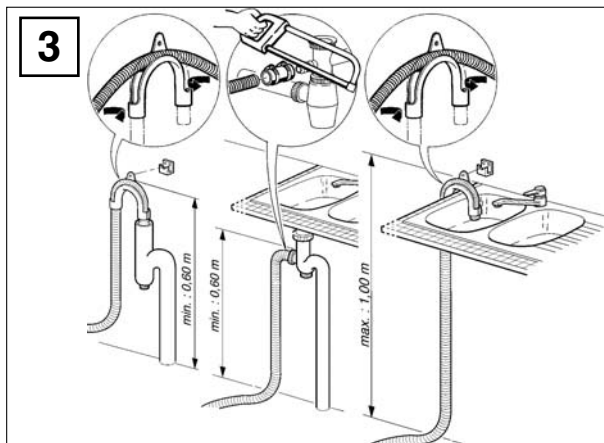
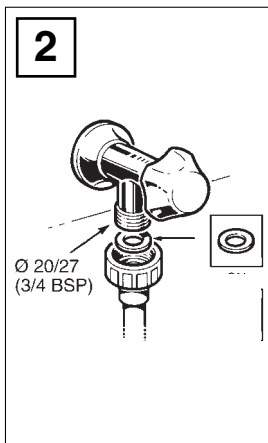
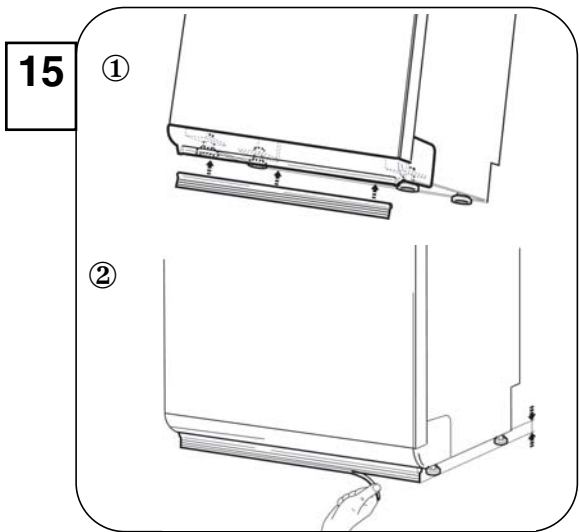

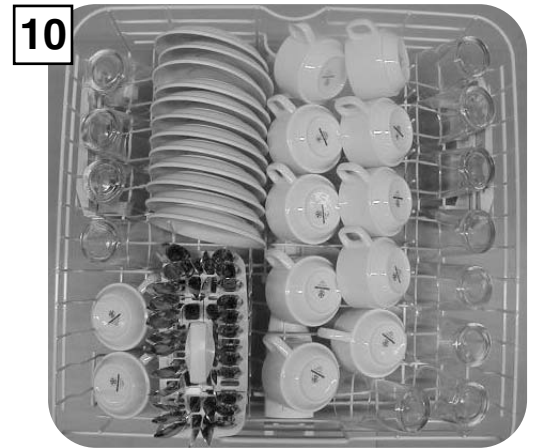
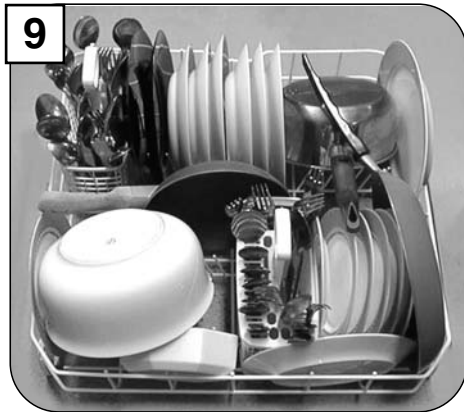
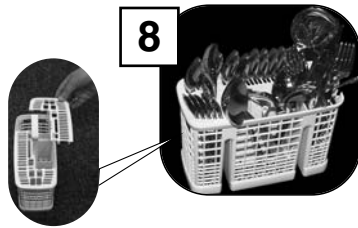
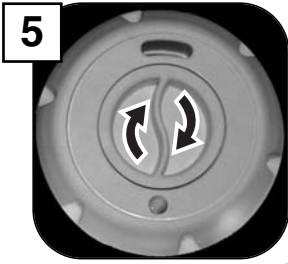

To make loading easier, move the tray to position ❶ and then return it to position ❷.

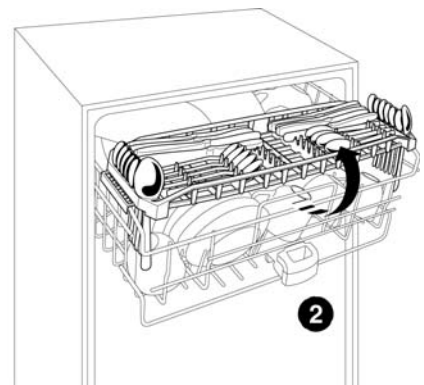
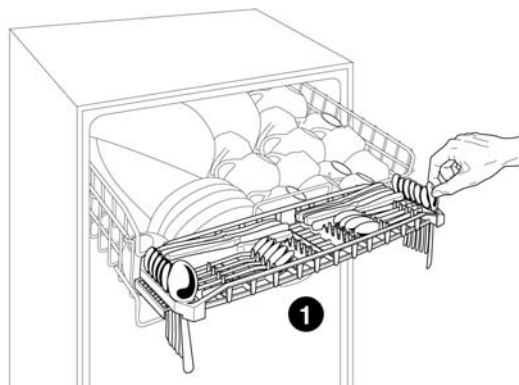

INSTRUCTIONS FOR LABORATORY TESTS

ENERGY EFFICIENCY TESTS ACCORDING TO AS/NZS 2007 PROGRAMME : NORMAL

Arrange items as shown in Figures **A – B – C**

Washing capacity : 13 standardised place setting

Detergent dose : 5+26,25 g of detergent

Detergent dispenser : 3

Setting of upper basket : *Low position*

The water softener MUST be set to \square (see page 7) to deactivate the device. No salt is required.
For more information on the comparison tests in accordance with AS/NZS 2007, please contact the manufacturer of the machine before commencing testing.

INSTRUCTIONS FOR LABORATORY TESTS : IEC LOAD

A

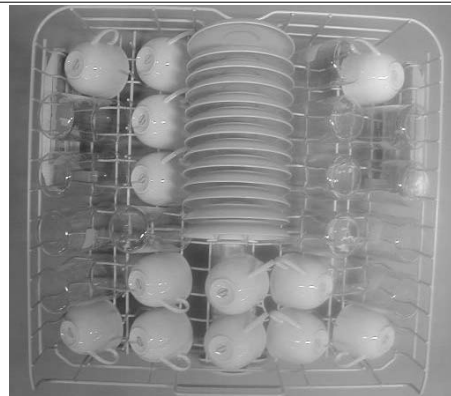

B

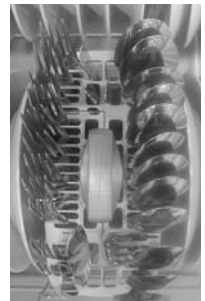
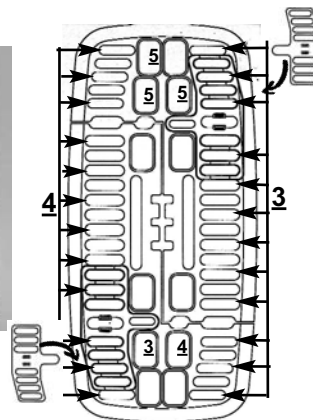
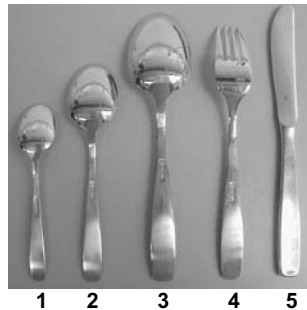
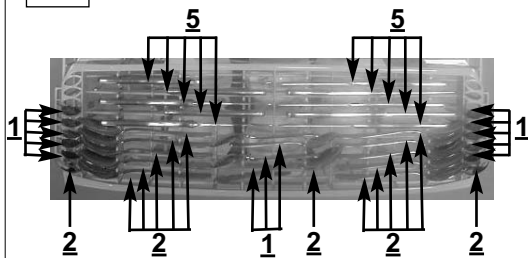

C

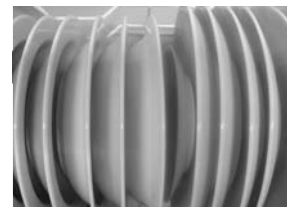
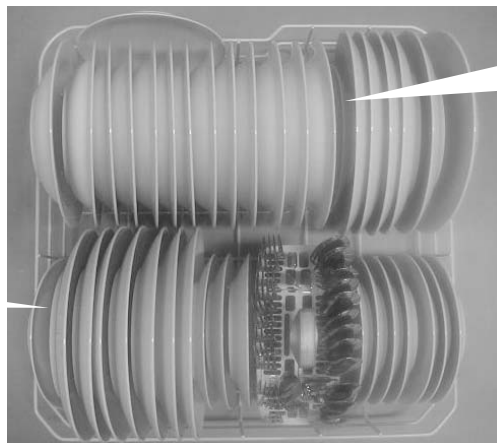

INSTRUCTIONS FOR LABORATORY TESTS : AS/NZS LOAD

A

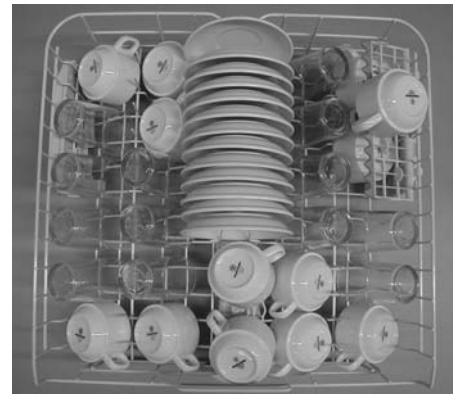
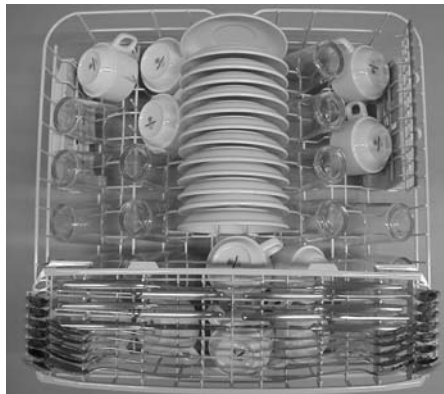

B

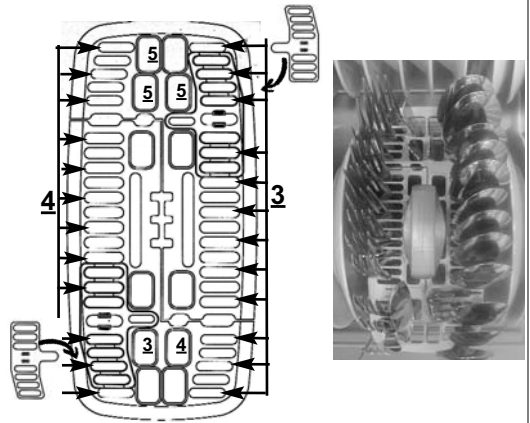
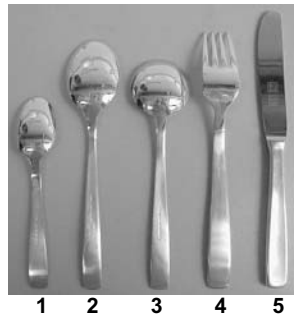
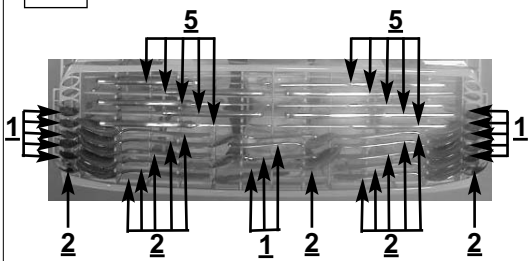

C

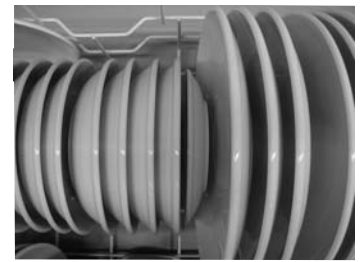
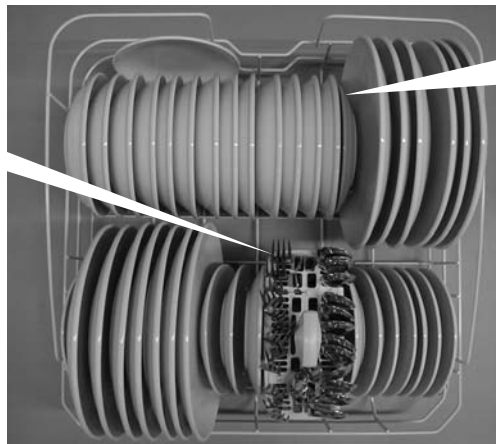
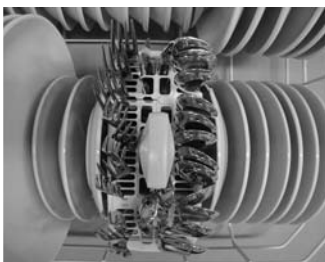

YOUR NOTES

WARRANTY AND SERVICE

DOMESTIC WARRANTY - FULL FIVE YEAR WARRANTY

In addition to all statutory rights which you, the Consumer, have under the relevant laws in respect of this appliance, during the first five years of ownership as the original purchaser of this Kleenmaid appliance, we guarantee that any fault caused by faulty material or workmanship becoming apparent will be rectified free of charge for parts and labour, provided that all service is performed during normal working hours by Kleenmaid or their designated Agents. Where the appliance is installed outside the normal servicing area of the above, the Purchaser must pay for the cost of transporting the appliance to and from the Agent or the Agent's travelling cost to and from the Purchaser's home.

COMMERCIAL WARRANTY - ONE YEAR WARRANTY

When this appliance is installed in a commercial application, you, the Consumer, have under the relevant laws in respect of this appliance, during your first one year of ownership as the original purchaser of the Kleenmaid appliance, we guarantee that any fault caused by faulty material or workmanship becoming apparent, will be rectified free of charge for parts and labour, provided that all service is performed during normal working hours by Kleenmaid or their designated Agents. Where the appliance is installed outside the normal servicing area of the above, the Purchaser must pay for the cost of transporting the appliance to and from the Agent or the Agent's travelling cost to and from the Purchaser's home.

WHAT THESE WARRANTIES DO NOT COVER

We are not responsible for any damage or malfunction unless caused by a defect in material or workmanship. This includes but is not limited to abuse, misuse, improper installation and transportation damage. We are not responsible for any consequential damages from any malfunction.

The Consumer, must make the appliance available for servicing and shall bear any costs incurred for any de-installation and/or re-installation required to make the appliance available for servicing. Kleenmaid are not liable for any consequential damage incurred during de-installation or re-installation.

WARRANTY DOES NOT COVER REPLACEMENT OF LIGHT GLOBES OR GLASS BREAKAGE DUE TO IMPACT

In case of fractured glass do not use your appliance.

WARRANTY REGISTRATION

Please complete warranty details below and retain together with your proof of purchase document. These documents will need to be viewed by our Service Representative should you request in warranty service.

SERVICE ASSISTANCE

To assist you when phoning our After Sales Service number to arrange a service call please complete the following details and have them ready when you call.

Model Number : _____ Date of purchase : _____

Kleenmaid Store purchased from : _____ Date of installation : _____

KLEENMAID AFTER SALES SERVICE
CONTACT NUMBER
1 300 652 100

**Other products in Kleenmaid's
range of world's best appliances :**

Washers

Dryers

Dishwashers

Ovens

Cooktops

Outdoor Cooking Centres

Built-In Coffee Machines

Rangehoods

Sinks

Waste Disposals

Taps

Cookware

Refrigerators

Freezers

Wine Cellars

Vacuum Cleaners

Free-Standing Ranges

**For sales informations on the full range of quality
kitchen and laundry appliances, phone 13 13 08**