

Cooking collection

Instructions for fitting and using your mixed induction-ceramic and Warranty Details

IVK60 - 600mm Induction-ceramic Cooktop



REF CONSTRUCTEUR 214

9962 9641 05/03

Congratulations on the purchase of your new appliance.
This appliance has been
designed and manufactured to give you years
of reliable performance.

For best results, carefully read the instructions on how to
install your new appliance. Correct installation will avoid
delays and unnecessary service calls.

Once installation is complete, read this booklet
carefully and get to know the controls and the
features of your new appliance.

We reserve the right to alter the specifications
with no influence on the operation of the
appliance. This instruction manual cannot be
reason for a claim.

List of contents

Using your hob in complete safety.....	4
Containers.....	6-7
Installing your hob in complete safety.....	8
Using your hob in all simplicity.....	10
Preserving and maintaining your hob.....	12
Small problems and solutions.....	13
Cooking	14-15

In this Manual,



*displays safety
instructions*



displays tips and hints

We have designed this hob for domestic use only.

With a view to constantly improving our products, we reserve the right to make technical and programming changes or modify the appearance.

This hob is designed solely for cooking food. No asbestos has been used in its manufacture.

We suggest that you should periodically check that there are no objects (glass, paper, etc.) that could obstruct the air inlet under your induction hob (See fitting).

Using your hob in complete safety

We have designed this hob for private use in homes.

With a view to constantly improving our products, we reserve the right to make any changes to their technical, program or aesthetic features connected with their technical evolution.

These hobs are exclusively designed for cooking and contain no asbestos based components.

We suggest that you should periodically check that there are no objects (glass, paper, etc.) that could obstruct the air inlet under your induction hob (See fitting)

HOB safety

- A sensor continuously monitors the temperature of the components of your hob. The power output by the hob will automatically be reduced if this temperature becomes excessive.

Induction safety area

- You only have to remove the pan from the hob to stop power instantaneously. Touch the "Off" touch control to turn off the heating zone completely.

• SAUCEPAN safety

Each unit is equipped with a sensor that continuously monitors the temperature of the bottom of the pan, so that overheating is impossible (empty saucepan, etc.).

• METALLIC OBJECT safety

A small object such as a fork, spoon or a ring placed on your induction hob **by itself** is not detected as a pan. The display flashes and there is no output power.

Residual heat indicator

The display shows **H**.

After a prolonged power cut, a light display may appear.

key for a while. However, the temperature of the cooking areas may remain high.

WARNING

Do not touch these areas, risk of burns.

Automatic-Stop

Automatic stop is a safety function for your hob. It starts up automatically if ever you forget to turn off your cooking.

Power consumed	The heating zone goes out automatically after
Between 1....4	8 hours
Between 5....7	2 hours
Between 8....9	1 hour

The letter **A** is displayed for the heating zone concerned and the hob will beep for about 2 minutes. The **A** will continue to be displayed until any control of the zone in question is touched. The hob will then beep twice to confirm your action.

WARNING!

The appliance is not intended for use by young children or infirm persons without supervision.

⚠ If your hob is placed above your oven (see "Choice of Installation") thermal protectors prevent it being used when the oven is being pyro-cleaned.

Your induction hob in complete safety

The principles of induction

When your induction hob is switched on and a heating power has been selected, the electronic circuits produce induced currents that instantaneously heat the bottom of the pan that transfers this heat to the food.

Thus cooking takes place with **practically no energy loss** between the induction hob and the food.

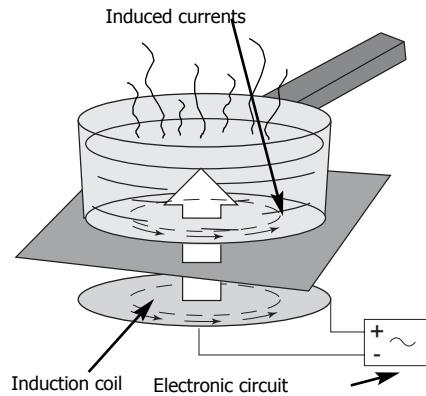

For the attention of wearers of pacemakers or other active implants:

The hob complies with all current standards on electromagnetic interference. Your induction hob is manufactured perfectly in keeping with legal requirements (89/336/CEE directives). It is designed not to create interference on any other electrical apparatus being used on condition that the apparatus in question also complies with this legislation.

Your induction hob generates short-range magnetic fields.

To avoid any interference between your induction hob and a pacemaker, the latter must be designed to comply with relevant regulations.

In this respect, we can only guarantee our own product conformity. Please consult the pacemaker manufacturer or your doctor concerning its conformity or any possible incompatibility.



If a crack appears in the glass surface, disconnect the appliance immediately to avoid any risk of electric shock. For disconnecting, remove the fuses or use the cutout switch.

Do not re-use your hob until the glass surface has been changed.



Your hob must never be used as a storage space or cutting surface for any products whatsoever.

When cooking never use aluminium foil and never place products wrapped in aluminium foil or products deep-frozen in aluminium packs on the hob.

The aluminium will melt and damage your appliance irreparably.

Do not leave empty pans on your hob in case of residual heat or if the hob is turned on by mistake.



Do not connect electrical appliances on plugs close to the hob. Make sure that the power cable is not in contact with any heating zones.

Induction pan area

You probably already have some suitable pans.

Your induction hob is able to recognise most types of pans.

Pan test: Place your pan on a zone, for example at position 4; you know that your pan is **compatible** if the display does not flash, but if it does flash then you cannot use this pan for induction cooking. You can also test it with a magnet: if the magnet "sticks" to the base of the pan, then you can use it for induction cooking.

Pans compatible with induction are:

- pans made of enamel coated steel with or without a non-stick coating.
- cast iron pans with or without enamel coated base.

An enamelled coated base will prevent the glass top of your hob from getting scratched.

- stainless steel pans designed for induction cooking.
- Most stainless steel pans (saucepans, stewpans, frying pans, deep frying pans, etc.) are suitable for induction cooking if they pass the pan test.

- aluminium pans with special base. Pans which do not have a flat base may be suitable, however they must not be badly deformed. Choose a pan marked with the **CLASS INDUCTION** logo on its base or packaging to be sure that it is perfectly suitable for use on your induction hob under normal conditions of use.

- Note
Glass, ceramic, aluminium pans (without a special base) and copper pans, and some non-magnetic stainless steel pans are incompatible with induction cooking. You will be informed by the flashing display.

You should choose pans with a thick flat base for uniform cooking (heat is better distributed).

Using the cooking zones according to the pan (depending on the model)

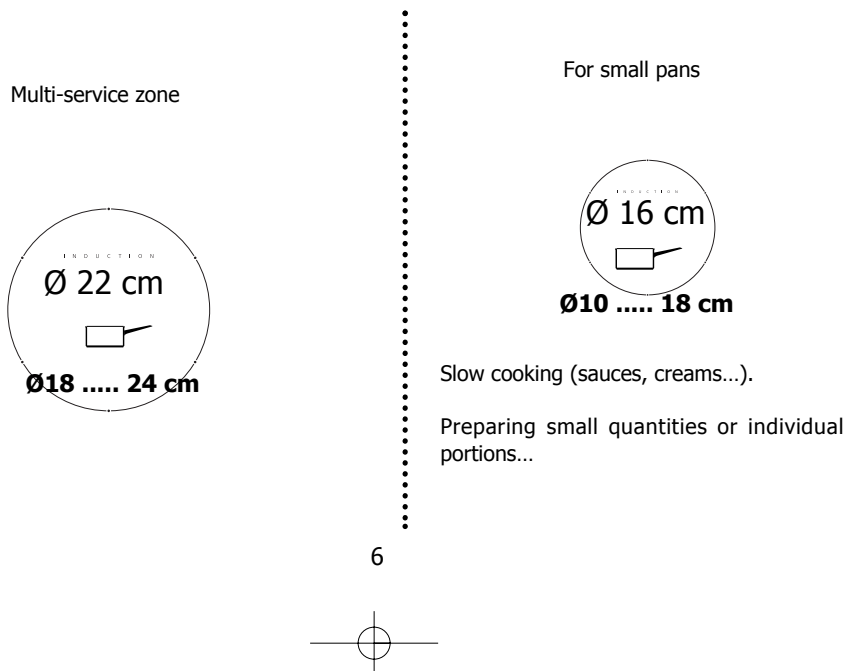

Vitroc ceramic pan area

Pans and casseroles must be designed for use with electric hobs.

Use pans with flat bases that have good surface contact with the cooking zone surface. They must be made out of:

- Stainless steel with a thick tri-metal or "sandwich" bottom.
- In aluminium with a thick smooth bottom.
- In enamelled steel.

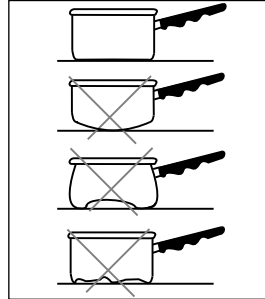

The best way to use your ceramic hob

For easy use, we have provided cooking zones specially adapted to your needs.

However, higher temperatures may be required for:

- Large quantities
- Cooking with a non-covered casserole.
- Using a glass or ceramic casserole.

And lower temperatures are required for:

- Cooking food products that tend to burn easily (start with a low temperature that can always be increased if possible).
- In case of overflowing (take the lid off, or remove the pan from the heat, then lower the temperature).

Energy saving:

To finish off cooking touch the control and reduce back to **0**. Leave the pan in place to use up all the accumulated heat (which saves energy).

Use a lid whenever possible to reduce any loss of heat through evaporation.

Automatic cooking zone temperature adjustment

The radiant cooking zone is self-regulating, it switches itself on and off so as to remain at the programmed power. Under these conditions the temperature remains constant and is correctly adapted to the food you are cooking. The frequency of self-regulation depends on the power being used.

Installing your hob in complete safety

Always ensure that the air vents beneath the hob are kept clear.
Your induction hob must always be adequately ventilated.

Above a cupboard or drawer unit

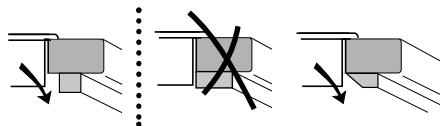
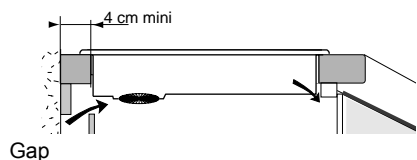

Ensure that the unit crossbar does not block the air passage, make a bevel if necessary.

Above an oven

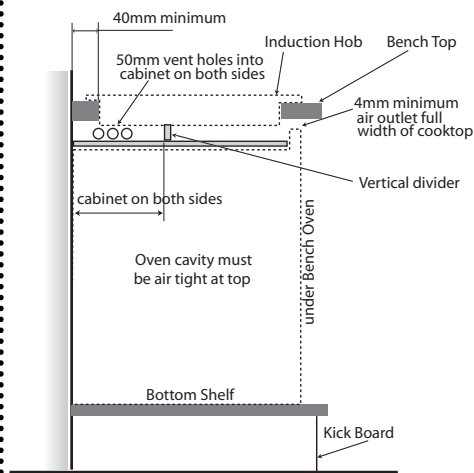

When installing induction hob above any oven the following ventilation requirements must be observed:

- * Divider shelf separating the hob from the oven to be positioned at least 50mm below hob.
- * Cooktop must be isolated from any oven cavity ie. under bench.
- * A vertical division to be positioned between the divider shelf and the underside of the hob approximately 300mm from the back of the cupboard.
- * Ventilation holes must be drilled into side of adjoining cupboards to allow supply of fresh air to cooktop. Incorrect installation may result in premature failure of cooktop and will void warranty.

WARNING: The installation instructions must be followed or warranty will be void.

Installing your hob in complete safety

Fitting

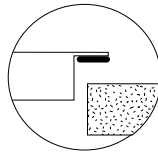
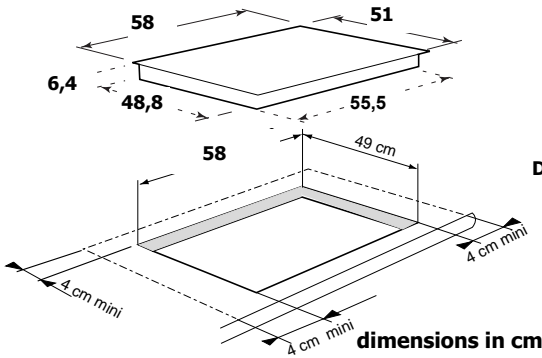

A seal exists for preventing any humidity getting under the hob.
 -Stick the seal under the rim of the hob and lower the hob into position on the worktop.
 -This seal is supplied in the sachet; stick it in place beneath the hob.

Depending on the clip model provided in the bag:

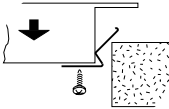

Fix the clips into position (supplied in the sachet).

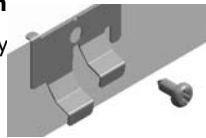

Screw the clips into position as shown below

The unit must be installed so that the mains plug is easily accessible.

Connection

These hobs are delivered with type H 05 VVF power cable (1.5mm²) with 5 conductors (including a green/yellow earth wire), which must be connected to the power supply via a plug that complies with publication CEI 60083 or an all-pole cut-out unit with contacts that open by at least 3mm.

If the cable is damaged, it must be replaced by an authorised Kleenmaid Service Agent or similarly qualified person for avoiding any possible risk of accident.

When the power is switched on, or after a long power failure, a light code appears on the control panel. This disappears automatically after about 30 seconds or as soon as any touch control is touched on the panel. This is normal, as the display is for use by the after-sales service when required. The user must not take this into account under any circumstances. If the unit has a 3 phase 400 V2N connection, and is not working correctly, check that the neutral wire is correctly connected. This precaution should also be taken for all your other electronic apparatus.

- 220-240 V monophase fuse 32

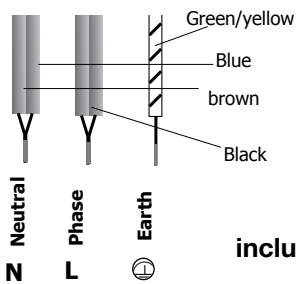

6 kW
including 2.8 kW for induction

- 400 V 2N three-phase fuse : 16 Amp

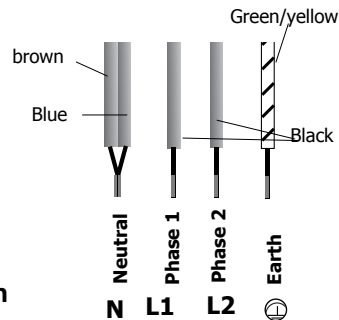

Separate the 2 phase wires L1 and L2 before connecting

What your hob looks like?

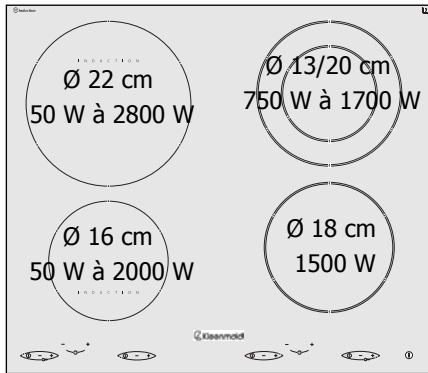

IVK60

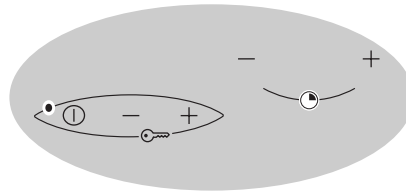

Start/Stop

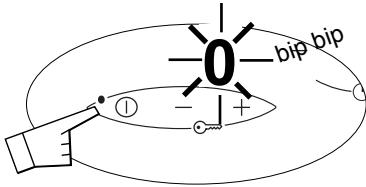

Setting manual power

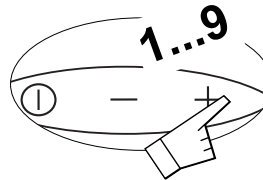

The hob beeps and a **0** blinks to indicate that the zone concerned has been turned on; you can then select the power you require. If you do not request any power the heating zone will turn itself off automatically.

⚠ The two induction zones have a **total power of 2800 W, which is divided up automatically** between them.

This implies, for example, that using maximum power in one zone will lead to the other zone's power being reduced automatically which will be shown on the power display.

The last instruction always has priority.

Using your hob in all simplicity

Setting the timer*

depending on the model

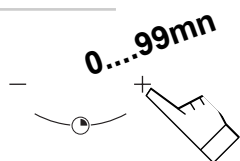

Operates when cooking zones concerned are working. You can modify cooking times at any time.

manual stopping

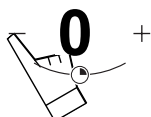

automatic stopping

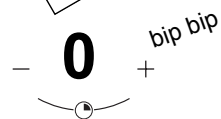

To stop the beep touch any control key in the cooking zone concerned. It will stop by default after about 1 minute.

Additional zone

To start it up:

Turn on your main cooking zone.

Press down on the "extra" touch control. A light will come on and the hob will beep to confirm that the extra zone has been turned on.

Adjust the zone to the heat you require.

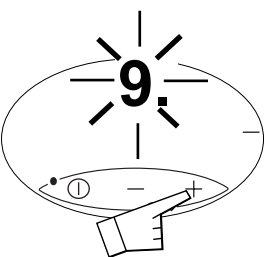
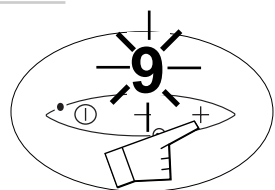

To turn it off:

Press down on the on / off touch control, then set the power you require.

Cutting off power to the main zone automatically cuts off the extra zone.

Child safety

Locked

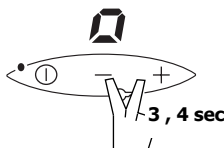

Controls can be locked:

- Either when turned off for cleaning.
- Or during use (the operations in progress continue and the settings displayed stay active).

However when in the locked position, the "STOP" touch control has priority and cuts off the power to the hob. The display turns off after a few seconds. It can be reactivated by touching any touch control.

Remember to switch back on again before use.

Unlocked

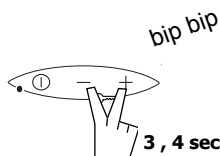

General stop button

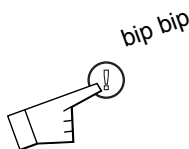

The general stop button turns off all cooking zones

Preserving and maintaining your hob

● **You must:**

Avoid any shocks with pans:

The glass surface is highly resistant but not unbreakable.

Avoid rubbing with any abrasive cleaners or with base of pans etc. as in time this will deteriorate the markings on the top of your ceramic hob.

Avoid using pans with rough or dented bases:

They may hold and transport matter liable to stain or scratch the hob.

Any such faults, which are not the cause of breakdowns nor make the hob impossible to use, are not included in the warranty conditions.

Place your pan **in the middle** of the heating zone.

Use a pan of the **right size**. The diameter of the base must be as big as, or bigger than the cooking zone surface area marked on the ceramic plate.

● **You must not**

Leave metal cooking utensils, knives and forks, or metal objects on the hob. They will get hot if left close to any heating zone that is in use.

Store ***MAINTENANCE*** or ***INFLAMMABLE*** products in the cupboard under your hob.

Leave an empty pan on a heating zone.

Heat up a closed can. It may burst; this recommendation applies to all methods of cooking.

Preheat at maximum temperature when using pans with non-stick inside surfaces (Teflon type). Use very little or no fat at all.

The maximum heating position is for boiling and frying only.

It is very easy to clean your hob, especially if you follow these few recommendations:

TYPE OF STAIN	WHAT TO DO	ACCESSORIES EMPLOYED
Minor	Soak the area to be cleaned with hot water, then wipe it.	Clean sponges
Accumulated burnt-on stains	Soak the area to be cleaned with hot water, use a special ceramic hob scraper to remove the worst, finish off with the rough side of a cleaning sponge, then wipe it clean.	Clean sponges special ceramic hob scraper
Rings and traces of limescale	Apply hot white spirit vinegar on the stain, leave to act then wipe off with a soft cloth. Use a commercial cleaner.	Special ceramic hob cleaner
Burnt-on stains following sugar spillage, melted aluminium or plastic.	Apply a special ceramic hob cleaner on the surface, preferably one which contains silicone (protective action).	Special ceramic hob cleaner



powder



abrasive-backed sponge



cream



ordinary sponge or special sponge for delicate items

Minor troubleshooting

You have doubts about whether your hob is working correctly this does not necessarily mean there is a breakdown. Nevertheless, check the following points

IF YOU REALIZE THAT	POSSIBLE CAUSES	WHAT SHOULD YOU DO?
When you switch on, the display lights up	The hob is working normally	NOTHING: see chapter Remarks on connections
When you switch on, the fuse blows	Your hob is connected incorrectly	Check the connection and make sure it complies with requirements.
When you switch on, only one side of the hob works	Your hob is connected incorrectly	
The fan keeps going for a few minutes after the hob has been switched off	The electronics are cooling down	This is normal.
The top of the hob is always warm (even when it is switched off).	The electronics are under power as for all other electronic apparatus (TV, transformers, etc.).	This is normal.
The hob does not work. Displays on the keyboard do not come on	The apparatus is not under power. There is a power or connection problem.	Inspect the fuses and the cut-out switch.
The hob has shut down during use, beeps every 10 seconds and  or F7 is displayed	Something has overflowed and/or an object is touching the control panel.	Clean the hob or remove the object in question and start cooking again.
A series of little  (or F7) appears	Electronic circuits have overheated.	See "Fitting your hob".
The hob does not work , another message comes on	The electronic circuit is working badly.	Call the After Sales Service
After having turned on a heating zone, the keyboard displays continue to flash.	The saucepan you use is unsuitable for induction cooking or its diameter is under 12 cm. (10 cm on the 160 mm zone).	See containers.
The pans make a noise during cooking	This comes from vibrations made by energy going from the hob to the pan.	Under high power this phenomenon is normal with certain types of pans. There is no danger for the hob.
The hob gives off a smell when first used for cooking	A new apparatus	Use each heating zone for ½ hour with a pan full of water.

If the slightest break or crack appears in the ceramic glass surface, disconnect the unit immediately and contact your After Sales Service.

DISHES	FRYING BRINGING TO THE BOIL		COOKING/BROWNING BRINGING BACK TO THE BOIL STEADY SIMMERING				COOKING KEEPING SIMMERING WARM		
	9	8	7	6	5	4	3	2	1
SOUPS									
FISH									
SAUCES									
VEGETABLES									
MEAT									
DEEP FRYING									
MISCELLANEOUS									





maximum power is reserved for frying and quick boiling.

- slow cooking
- fast cooking
- boil or fry
- boil with cover
- add food

induction

DISHES	MAXI 9	VERY HOT 8-7	HOT 6	MEDIUM 5-4	SIMMERING REHEATING 3 2	KEEPING WARM 1
SOUPS	BROTH THICK SOUP					
FISH	STOCK FROZEN					
SAUCES	THICK, MADE WITH FLOUR MADE WITH BUTTER AND EGGS (BEARNAISE, HOLLANDAISE)					
VEGETABLES	CHICORY, SPINACH PULSES BOILED POTATOES FRIED POTATOES SAUTE POTATOES DEFROSTING VEGETABLES					
MEAT	THINLY SLICED MEAT FRYING STEAKS GRILLING (CAST IRON GRILL PAN)					
DEEP FRYING	FROZEN CHIPS FRESH CHIPS					
MISCELLANEOUS	PRESSURE COOKER STEWED FRUIT PANCAKES CUSTARD MELTING CHOCOLATE JAM MILK FRIED EGGS PASTA BABY FOOD IN JARS (BAIN MARIE) STEWES CREOLE RICE RICE PUDDING					

maximum power is reserved for frying and quick boiling.

-  slow cooking
-  fast cooking
-  boil or fry
-  boil with cover
-  add food

ceramic hob

WARRANTY AND SERVICE

DOMESTIC WARRANTY - FULL FIVE YEAR WARRANTY

In addition to all statutory rights which you, the Consumer, have under the relevant laws in respect of this appliance, during the first five years of ownership as the original purchaser of this Kleenmaid appliance, we guarantee that any fault caused by faulty material or workmanship becoming apparent will be rectified free of charge for parts and labour, provided that all service is performed during normal working hours by Kleenmaid or their designated Agents. Where the appliance is installed outside the normal servicing area of the above, the Purchaser must pay for the cost of transporting the appliance to and from the Agent or the Agent's travelling cost to and from the Purchaser's home.

COMMERCIAL WARRANTY - ONE YEAR WARRANTY

When this appliance is installed in a commercial application, you, the Consumer, have under the relevant laws in respect of this appliance, during your first one year of ownership as the original purchaser of this Kleenmaid appliance, we guarantee that any fault caused by faulty material or workmanship becoming apparent, will be rectified free of charge for parts and labour, provided that all service is performed during normal working hours by Kleenmaid or their designated Agents. Where the appliance is installed outside the normal servicing area of the above, the Purchaser must pay for the cost of transporting the appliance to and from the Agent or the Agent's travelling cost to and from the Purchaser's home.

WHAT THESE WARRANTIES DO NOT COVER

We are not responsible for any damage or malfunction unless caused by a defect in material or workmanship. This includes but is not limited to abuse, misuse, improper installation and transportation damage. We are not responsible for any consequential damages from any malfunction.

The Consumer must make the appliance available for servicing and shall bear any costs incurred for any de-installation and/or re-installation required to make the appliance available for servicing. Kleenmaid is not liable for any consequential damage incurred during de-installation or re-installation.

WARRANTY DOES NOT COVER REPLACEMENT OF LIGHT GLOBES OR GLASS BREAKAGE DUE TO IMPACT

In case of fractured glass do not use your appliance.

WARRANTY REGISTRATION

Please complete warranty details below and retain together with your proof of purchase document. These documents will need to be viewed by our Service Representative should you request in warranty service.

SERVICE ASSISTANCE

To assist you when phoning our After Sales Service number to arrange a service call please complete the following details and have them ready when you call.

Model Number _____ Date of purchase _____

Kleenmaid Store purchased from _____ Date of installation _____

***KLEENMAID AFTER SALES SERVICE
1300 652 100***

**Other products available in the Kleenmaid
Range of appliances**

Washers

Dryers

Dishwashers

Ovens

Cooktops

Outdoor Cooking Centres

Built In Espresso Coffee Machines

Rangehoods

Freestanding Ranges

Sinks

Waste Disposals

Taps

Cookware

Refrigerators

Freezers

Wine Cellars

Vacuum Cleaners

**For sales information on the full range of quality appliances
Phone 13 13 08**

 **Kleenmaid**
The best you can own.

July 03