

Laundry Collection

Instructions for Use
KED2000

 **Kleenmaid**
The best you can own.

Contents

YOUR KLEENMAID DRYING MACHINE	3
IMPORTANT SAFETY INSTRUCTIONS	4
INSTALLATION INSTRUCTIONS	5
Introduction	5
Information concerning waste disposal	5
Before installing the dryer	5
Exhaust air connection	7
Dryer connection options	7
Accessories	10
Installation – step by step	10
Preparing to transport the dryer – step by step	10
OPERATING INSTRUCTIONS	11
Your new dryer	11
Panel	12
Summary of instructions	13
Safety information	14
Before switching on the dryer	14
Using the dryer	14
Protecting the dryer	14
Protection of the environment	14
Before using the dryer for the first time	15
Temporary disconnection of the dryer	15
Laundry	15
Sorting according to the fabric type	15
Drying tips	15
Program selection	16
Automatic programs	16
Mixed Load	16
Specials	16
Time programs	16
Additional options	17
Options	18
Status indicator	18
Program selection table	19
Operation	21
Using the dryer	21
Using the dryer rack	22
Cleaning and care	25
Cleaning the dryer	25
Cleaning the filter	25
Cleaning the exhaust duct	25
Cleaning the moisture sensor	26
Cleaning the bearing shield	26
Change the light bulb	26
Troubleshooting	27

YOUR KLEENMAID DRYING MACHINE

Congratulations on having selected a Kleenmaid clothes dryer, the choice of those that demand exceptional performance from their clothes dryer.

A distinctive feature of your dryer is low energy consumption.

An easy operation philosophy, a variety of customized drying programs and a solid touch and feel make this appliance a user-friendly assistant in your household.

The Kleenmaid dryer offers the following standard features:

- High efficiency precision drying system
- Large stainless steel drum with a capacity up to 10 kg
- Large port hole, door lock with automatic drum stop function
- Sensor controlled auto cycles
- Timed cycles from 10 to 150 minutes.

Each dryer which leaves our factory has undergone a thorough performance test and is in full working condition.

Further information and a selection of our products can be found on our web site:

www.kleenmaid.com

Information

Please read and follow these operating and installation instructions and all other information enclosed with the dryer.



This symbol is used to inform the user of safety issues.



This symbol is used to draw the user's attention to important matters.



IMPORTANT SAFETY INSTRUCTIONS

- Emergency** – Pull out the mains plug immediately or disconnect the fuse.
- Use dryer ONLY ...** – in the house.
– for drying textiles.
- NEVER use dry ...** – for purposes than those described above.
– modify the technology or properties of the dryer.
- Hazards** – Children and uninstructed persons must not use the dryer.
– Do not leave children unsupervised near the dryer.
– Keep pets away from the dryer!
– Take all objects out of the pockets.
Look out for cigarette lighters → risk of explosion!
– Do not lean or sit on the door → risk of dryer tipping over!
– Open the door carefully. Hot steam may escape.
- Installation** – Frost damage possible below 0 °C.
– Attach loose cables or hoses, otherwise risk of tripping.
– Observe the safety instructions in the installation instructions for the exhaust air duct!
- Mains** – Connect the dryer to an a.c. earthed socket, otherwise safety cannot be ensured.
– Cable cross-section must be adequate.
– Only use a residual-current-operated circuit breaker with this symbol: 
– Mains plug and socket must match.
– Do not use multiple plugs/couplings or extension cables.
– Do not take hold of the mains plug with damp hands.
– Never pull the mains plug out of the socket by tugging the cable.
– Do not damage the power cord.
- Operation** – Load the drum with *washing only*. Check the contents before switching on the dryer.
– Do not use the dryer if the washing has been previously treated using cleaning agents containing solvents (such as stain remover/benzine) or has come into contact with wax, grease or ink (e.g. setting lotion, nail varnish remover) → risk of fire/explosion!
– Dust hazard (e.g. coal dust, flour): do not use the dryer → risk of explosion!
– Do not use the dryer if the washing contains foam/rubber → The elasticity may be impaired and the dryer may be possibly damaged through the deformed pieces.
– Make sure the dryer is well ventilated while it is in operation.
– Switch off the dryer at the end of the program.
- Defect** – Do not use the dryer if it is defective or is considered to be defective.
Repairs by customer service only.
– Do not use the dryer if the power cord is defective.
To prevent hazards, only allow customer service to replace a defective power cord.
– Before changing the interior light bulb, always pull the mains plug out of the socket.
- Spare parts** – For reasons of safety use original spare parts and accessories only.
- Disposal** – Dryer: pull out the mains plug, **then** sever the power cord from the appliance.
Dispose of it at a public waste disposal centre.
– Packaging: Do not let children play with packaging parts → risk of suffocation!
– All packaging materials are environmentally friendly and can be reused.
Dispose of it at a public waste disposal centre.

INSTALLATION INSTRUCTIONS

Introduction

Read these installation instructions completely and carefully. They will save you time and effort and help to ensure optimum dryer performance. Be sure to observe all listed warnings and cautions.

Information concerning waste disposal

Disposal of packaging

All packaging materials are environmentally friendly and can be reused. Please dispose of packaging in an environmentally friendly manner.

Please ask your dealer or inquire at your local authority about the current means of disposal.

Disposal of the old appliance

To prevent children from locking themselves in the appliance, remove the door.

Old appliances are not worthless rubbish! Valuable raw materials can be reclaimed from environmentally friendly recycling.

Please ask your dealer or inquire at your local authority about the current means of disposal.

-  Do not leave children unattended near the dryer!
Keep pets away from the dryer!

WEEE

 This appliance has been identified in accordance with the European Directive 2002/96/EG on Waste Electrical and Electronic Equipment (WEEE). The Directive specifies the framework for an EU-wide valid return and recycling of waste appliances.

Before installing the dryer

Unpack the dryer.

- Check dryer for damage which may have been caused in transit!
- The dryer is heavy. Do not lift it by yourself.
- Beware of sharp edges.
- Do not operate the dryer if there is a risk of frost! Freezing water may result in damage!
- If in doubt, have a technician connect the appliance!
- Do not lift the dryer by projecting components (e.g. door) – risk of breakage!
- It is recommended to install an exhaust air duct.
- Do not connect a dryer which is visibly damaged. If in doubt, contact your dealer.
- Never use a damaged dryer! Notify customer service!

Standard accessories

The dryer is delivered as a complete unit. The operating instructions and supplied accessories can be found in the drum.

-  Take all accessories out of the drum. The drum must be empty!

Mains Connection

-  Only touch the mains plug with dry hands!
Only touch the mains plug!
- Connect correctly to an a.c. earthed socket. If in doubt, have the socket checked by an electrician!
 - The mains voltage must correspond with the voltage specification on the appliance rating plate (see Page NO TAG). The wattage and required fuse are indicated on the appliance rating plate.

This appliance is made to be used in a power distribution system which has an impedance of 0.2 ohm (max.) at the transfer point between the power distribution system and the residence site.

The user has to insure that the appliance will only be operated in a power distribution system that fulfills this requirement. Please ask your power supply company if you are unsure about the system impedance.

Installation location

⚠ Installation

- The power supply plug must remain accessible at all times!
- The installation surface for the dryer must be clean, level and firm.
- Keep the area around the dryer clean.
- Align the dryer with the heightadjustable feet. Use a spirit level.
- Never remove the height-adjustable feet!
- Do not install the dryer behind a lockable door, a sliding door or a door with a hinge facing the dryer.
- Install the exhaust air duct. Follow the exhaust air duct installation instructions.

⚠ Do not operate the dryer if there is a risk of frost!

The installation room must be well ventilated, otherwise the dryer will operate below optimum performance.

Do not operate the dryer at temperatures above 40 °C and below 5 °C. Low temperatures affect the automatic program sequence and may prolong the drying times.

Do not install the appliance on carpets! Compensate for uneven floors with the height-adjustable feet.

The size of the installation area depends on the dimensions of the dryer. Ensure that there is adequate room for the swivel range of the door!



	Dimension	Weight
a	686 mm	56 kg
b	808 mm	with packaging
c	945 mm	64 kg
d	500 mm	
angle	170 – 180°	

If installing the dryer in a closet, observe the minimum distances according to the following table:

Minimum Installation Clearances

	Closet
Sides	0 mm
Top	305 mm
Rear*	0 mm

* as close to wall as venting will allow.

Important information concerning minimum distances:

- Depending on the location of the exhaust air connection, an additional minimum distance of 14 cm must be provided on this side for pipes/brackets (see Page 7).
- Distances above the indicated minimum dimensions reduce the risk of mold formation behind the appliance.
- Additional distances reduce noise transmission.
- Additional distances facilitate installation and service.
- If the dryer is installed in a small room, the doors of the room must be fitted with vents of a specified minimum size.

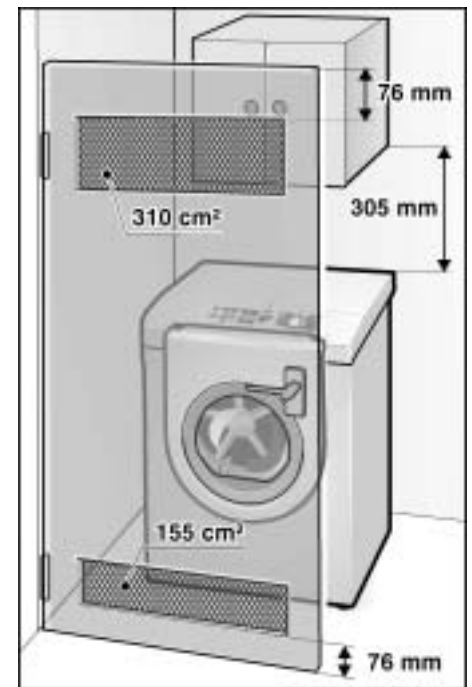

The dryer door is delivered with hinges on the right. If required, the door hinges can be switched to the left side.

If the door hinges are to be changed over, please contact your dealer or our customer service-team (see Page NO TAG).

Exhaust air connection

Safety Information

- It is recommended that exhaust air is conducted directly into the open air through an exhaust air duct.
- A non-return valve must be fitted in order to ensure that exhaust air is conducted directly into the open air (so that air is prevented from flowing back)
- The exhaust air system should only be installed as described in these instructions.
- The stated pressure losses must not be exceeded.
- Use only parts and materials mentioned in the instructions.
- The exhaust air duct should be cleaned regularly, at least once a year.
- Shift the exhaust air such, so that the dryer cannot draw the damp air which is blown out, back in again.
- Design and/or shift the exhaust air duct such, so that there is no possibility of additional counter-pressure (e.g. through direct incidental wind) arising for the exhaust air which flows out.

When the dryer is operated without an exhaust air duct, pay attention to the following:

- Make sure there is good room ventilation → risk of damage caused by moisture. e.g. to walls, furniture.
- Do not obstruct the exhaust air vent (free space around exhaust air vent of approx. 1 m).
- Remove any lint accumulation around the dryer.

The Kleenmaid dryers are intended to be vented outdoors. To prevent build-up of moisture and accumulation of lint indoors, as well as to maintain maximum drying efficiency, it is recommended that the dryer is vented outdoors.

Be sure to observe the following if connecting via a wall box in a chimney or ventilation shaft:

- You should not connect the exhaust air outlet to chimneys where gas-fired or coal-fired ovens and/or cookers or gas-fired heating is connected,
- When connecting to a damp-proof ventilation shaft, inform the appropriate chimney sweep and/or obtain permission from the local planning office/owner
- If additional appliances are operated in the room where the dryer is set up or in neighbouring rooms, such as gas heaters, gas-fired instant water heaters, coal-fired ovens with a chimney connection or open fireplaces, a sub-pressure can arise which leads to the effect of gases being drawn back → **risk of intoxication.**
- In every event, confirm with the appropriate chimney sweep that the installation is safe to operate!

Dryer connection options

Rear panel connection

The dryer provides exhaust outlets to the right-hand side and to the rear. The dryer is delivered with the exhaust air outlet on the rear of the appliance open.

The exhaust outlet on the right-hand side of the dryer is closed and covered.

Connection on right side

The dryer exhaust can be switched between the side and rear exhaust ports.

Follow these steps to change between the exhaust ports.

1. The dryer is shipped with the side exhaust port closed and covered.
2. Remove the cover from the side panel.
3. Remove the bayonet ring from the rear panel and attach it to the side panel port.
4. Close off the rear panel with the cover.

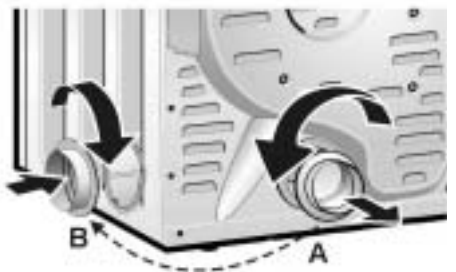

Ductwork

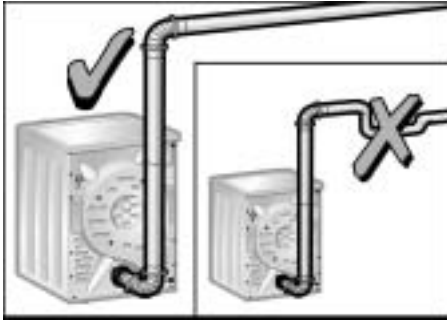

To ensure optimum performance, the ducting system of the dryer should be as short as possible with a minimum number of elbows. Your dryer will work best when the venting system has as few air flow restrictions as possible. Exhaust ducting which is longer than recommended may extend drying time, cause lint to accumulate and affect dryer performance and dryer life-time.

Where possible, smooth, rigid ducts should be used with a diameter of at least 100 mm.

DO NOT assemble the ductwork with screws or fasteners that extend into the duct. They will serve as an accumulation point for lint.

Joints should be secured with aluminum tape.

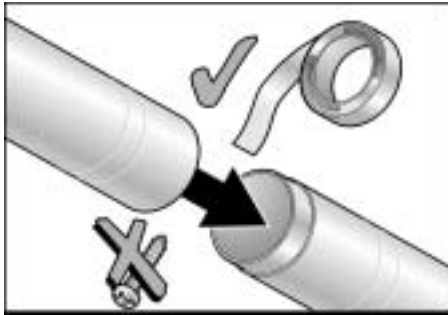

All joints should be tight to avoid leaks. The male end of each duct section must point away from the dryer.

Whether connecting to an existing venting system or a new venting system, make sure that all ducting is clean and free of lint.

Pressure drops

The length and type of exhaust air duct used can impede air flow, especially angle elbows with a small radius. → Diameter reductions and pressure drops (resistances) should be kept to a minimum.

The following should be avoided

- Long exhaust air ducts.
- Exhaust air ducts with a small cross-section.
- Exhaust air ducts with many bends and angle joints

Pressure drops due to friction

Air flow is influenced by frictional resistances in the duct and/or tube, ie. by friction on the inside of the exhaust air duct, and can be effected in the following ways:

- the smoother the internal wall
- the larger the diameter of the internal wall
- the shorter the tube

The lower the frictional resistance.

Pressure drops due to fittings

Exhaust air is subject to additional resistance from fittings, e.g. from bypass adapters (elbows, bends, angle joints), wall boxes fitted with a grill or a oneway flap.

Installation with tube connection – inside diameter – 100 mm

To ensure the minimum air flow requirement, a specific pressure drop (resistance) must not be exceeded.

The total permissible pressure drop for an exhaust air duct must not exceed a specific numerical value. It is calculated from the sum of all the individual pressure drop values taken both from the straight sections and from the fittings in the exhaust air duct.

Enlarge the inside diameter of the duct connection when connecting a duct connection with an inside diameter of 100 mm and a total pressure drop of 50*.

** To determine the total pressure drop value see the table on Page 9.*



The numerical value for the maximum permissible total pressure drop in an exhaust air duct is 50 (see chart below).

Individual pressure drop values – calculate your system's total pressure loss using these values

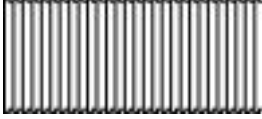
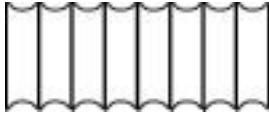
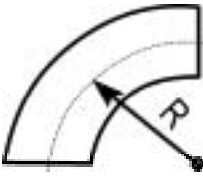
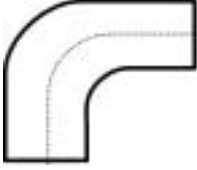
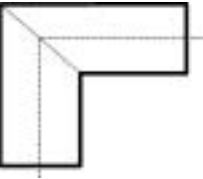
	Smooth tube	Grooved flexible tube	Corrugated flex. tube
Inner Wall			
Type			
straight section (per 1 m)	4	6	12
fittings			
 elbows R = 300 mm R = 200 mm R = 100 mm	3	5	7
	4	7	8
	6	9	10
 bend	10	16	17
 angle	19	22	24
Telescope – wall box with grille		14	
Wall box with one-way flap		6	

Total pressure drop values

Permissible pressure drop	Duct connection – inside diameter in mm
0 – 50	100
0 – 80	110
0 – 124	120
0 – 186	130

Accessories

The parts required for the exhaust air system can be obtained from customer service or your local dealer. Please follow the installation instructions supplied by the appropriate manufacturer!

Left hinge kit

part no. **WTZ1260**

The door catch can be reversed if necessary. The door is hinged on the right at the factory.

Pedestal Mounting Kit

Part no.: **WMZ20400**

If mounting the dryer on the pedestal, follow the instructions supplied with the pedestal.

Installation – step by step

1. Unpack the dryer.
2. Remove all objects from the drum.
3. Check the dryer for visible damage.
4. Position the dryer near the installation location.
5. If required, change the door hinges to the left (see Page 10).
6. If required, have customer service install the exhaust air outlet on the dryer (see Page 7)
7. Install exhaust duct, if necessary. Follow the installation instructions supplied by the appropriate manufacturer!

i If space is very restricted, it is recommended to fit the initial parts of the exhaust duct to the dryer before the dryer is moved to its final installation location.

8. Move the dryer to its final location and align.

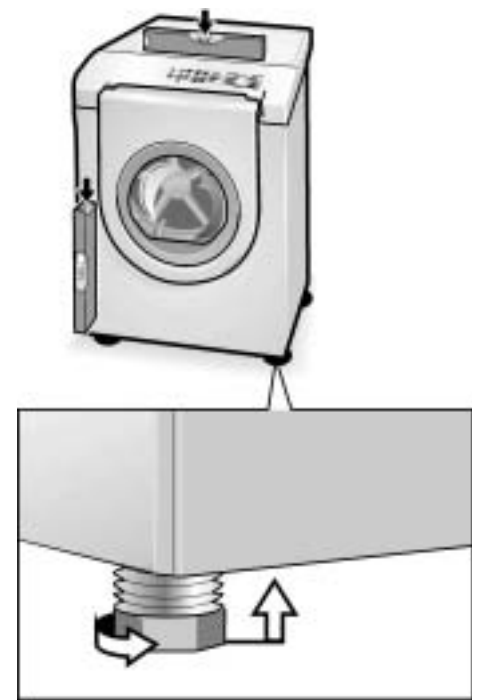

The dryer should be level with all four feet firmly on the ground. The dryer must not wobble. Adjust the height-adjustable feet until the dryer does not rock and is level, both front-to-back and side-to-side.

9. Connect the exhaust duct to the exhaust air outlet on the dryer.
10. Insert the mains plug into the socket.

Preparing to transport the dryer – step by step

1. Rotate the program selector to **Off**.
2. Pull out power supply plug.
3. Disconnect the exhaust duct from the exhaust air outlet on the dryer.
4. Place any accessories in the drum.
5. Close the door and secure with adhesive tape.
6. Screw the height-adjustable feet of the dryer into the housing to prevent them from being damaged during transportation.

OPERATING INSTRUCTIONS

Your new dryer

Open the door ... (colored marking)



... and close the door.

Filter



Panel

Start/Pause button

Starts, interrupts and ends the drying process.

Buttons for Options (in addition to the program if required). See Page 18.

Low Heat

Press for temperature-sensitive textiles (e.g. acrylic fibers). The temperature of the drying process is reduced, the drying time is extended correspondingly.

Reduced Ironing

Extends the **Anti crease** function to 3 hours (standard 1 hour).

Display

Indicates the settings of the additional options and the estimated remaining time of programs.

Indicator light (LED) Filter

indicator flashes if the filter is clogged indicating need to clean the filter (see Page 25)



Program selector

Selects a program. See Page 16.

Can be rotated in either direction.

To switch off the dryer, rotate the program selector to **Off**.

Indicator lights (LED)

Indicate the current moisture state of the drying process.

Buttons for additional options

See Page 17.

Menu

Selects one of the additional options.

Select

Changes the settings of the additional options.

Summary of instructions

Preparing the dryer

i Check the filter. The filter should be cleaned after and before every drying process.



Selecting a program



Change the settings of additional options



Choose an option ...

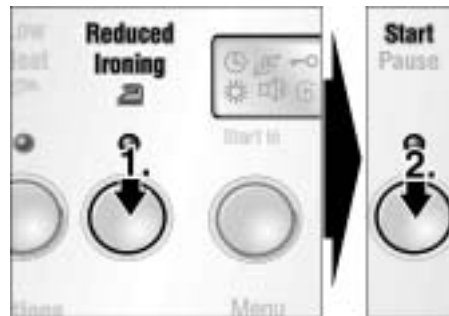

... and start the dryer

Switch off the dryer



Using the dryer basket

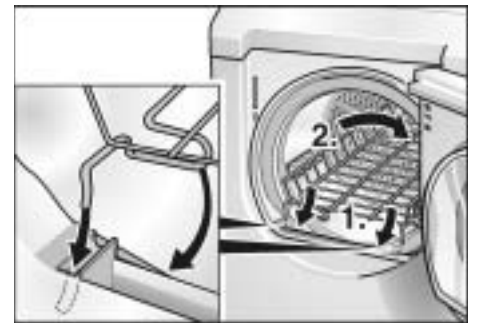

Safety information

 Do not dry the following textiles in the dryer:

- Airtight textiles (e.g. rubberised).
- Delicate fabrics (silk, synthetic curtains) → creases will form!
- Dripping wet washing → high energy consumption!
- Oilcontaminated washing.

Use the dryer only in the house or the garage for drying normal amounts of laundry for the household.

Use only for drying textiles which were washed with water.

Before switching on the dryer

Install the dryer in accordance with the installation instructions (from Page 5).

Do not use a dryer which is visibly damaged. If in doubt, contact your dealer.

Using the dryer

Do not leave children unattended near the dryer!

Keep pets away from the dryer. Before closing the door, check the contents of the drum.

Remove all objects from pockets. Lighters are particularly hazardous.

Risk of explosion!

Switch off the dryer at the end of the program.

Protecting the dryer

Do not climb on the dryer.

Do not lean or sit on the door.

Risk of dryer tipping over!

Do not store or use solvent detergent boosters or stain remover in the vicinity of the dryer.

The dryer could be damaged.

Do not lift the dryer by projecting components. **Risk of breakage!**

Protection of the environment

Tips on saving energy

To save energy, money and time, Kleenmaid recommends the following:

- **Drain the laundry thoroughly!**
Before drying, spin the laundry thoroughly in the washing machine. Use the highest possible spin speed for the type of laundry! Higher spin speeds reduce the drying time and the energy consumption.
- **Use optimum load!**
Use maximum recommended loads. However, do not exceed loads.
- **Clean filter!**
Clean the filter before and after each drying process (see Page 25).
- **Ventilate the room!**
During the drying process provide an adequate supply of fresh air.
- **Do not dry unsuitable materials!**
Do not dry rubberized or air-tight items.
- **Do clean and inspect the exhaust system on a regular basis!**
Restrictions can prolong the duration of the drying process.

Before using the dryer for the first time

Before you use the dryer for the first time:

1. Read these operating instructions carefully.
2. Check that the supply voltage corresponds with the voltage specifications on the rating plate of the dryer, see picture Page NO TAG.
3. Remove all objects from the drum.
4. Check the dryer for visible damage. If damages found contact your dealer.
5. Wipe the inside of the drum with a damp cloth.
6. If the dryer does not work, switch the dryer to **Off**.
Look in the **Troubleshooting** section (see Page 27) of the operating instructions and find the fault.

Temporary disconnection of the dryer

Operate your dryer only when you are at home. If you intend going on vacation or are not using your dryer for an extended period of time, you should:

1. Pull out the mains plug.
2. Clean the filter.

Laundry

Sorting according to the fabric type

Observe the care information or symbols on the textiles. They provide valuable information as well as limitations about the drying process.

Do not dry the following textiles in the dryer:

- Air-tight textiles (e.g. rubberized).
- Delicate fabrics (silk, synthetic curtains).

i Dry woolen or wool-rich textiles with dryer basket only!

i Use the time program **Short Programme** to dry articles containing foam rubber or similarly textured rubber-like materials.

Drying tips

In principle, the following applies to all drying programs:

- To ensure a uniform drying result, sort the laundry according to the fabric type and the drying programme.
- Fasten zippers, hooks and eyes. Fasten loose belts, apron strings, etc..
- Do not overdry easycare laundry – risk of wrinkling! Leave laundry to dry in the air.
- Do not iron laundry immediately after drying. Place the laundry in a pile for a short while. Residual moisture will then be distributed uniformly.
- Knitted textiles (e.g. T-shirts, cotton jersey laundry) often shrink when dried for the first time. Do not use the **Very Dry/Extra Dry** program.

Program selection

For optimum drying results your dryer offers several program groups and additional options.

Select the required drying program from the program table according to the examples (see Page 19).

Automatic programs

There are automatic programs for different types of textiles (Cottons, Easy-Care, Mixed Load).

Cottons



Easy-Care



The program sequence of automatic programs is controlled via sensors. The duration of the program depends on the measured degree of moisture in the laundry and on the selected degree of dryness (e.g. **Iron Dry** or **Extra Dry**).

Mixed Load



There are mix-programmes (**Very Dry**, **Cupboard Dry**) for different types of fabric

- i If you choose an automatic or mixed-load programme, the display immediately shows the estimated time remaining.

Specials



The programs **Woollens Finish**, **Woollens** and **Short Programme** are made for special application cases. The duration of the Woollens program must be adjusted via the **Select** button. Possible Settings: 0:00–2:30 h in 10 min. steps.

- i Dry woolen or wool-rich textiles with dryer basket only!

Time programs



Time programs run at specific temperatures

- **Sportswear**
for temperature insensitive textiles.
- **Warm**
for temperature sensitive textiles.
- **Cold**
for extreme temperature sensitive textiles.

The duration of the drying process must be adjusted via the **Select** button. Possible Settings: 0:00–2:30 h in 10 min. steps.







- i If you choose a programme with variable time, (**Timed Programmes**, **Woollens**), the display starts to flash. You have to set the time.

- i It is necessary to use the drying basket when the **Woollens Drying Basket** programme is selected.

Additional options

- i** Before setting additional options, choose a program with program selector!



Sym- bol	Function	Possible setting
	Sets the delay start time of the dryer (Start in .. hours!)	0–12 h (0.5 h steps)
	Extra care (more gentle than Low Heat )	On/Off
	Child-proof lock (only effective while the program is running)	On/Off
	Precision setting of the desired degree of dryness	0, 1, 2, 3
	Volume of the end signal and the Iron Dry signal.	Off, continuous, maximum see table on Page 18
	Coordinates the remaining time display to the spin speed at which the laundry was previously spun in the washing machine	400 600 800 1000 1200

Select the option to be changed with the **Menu** button. Press the button to jump to the next option on the display. The active symbol starts flashing.

The current active option setting is displayed on the right.



These settings can now be changed with the **Select** button. Press the button to jump to the next possible setting.

- i** Pressing the **Menu** button again, saves the previously settings. If you don't press any button for 10 seconds the settings are saved automatically.

Start Delay

- i** If you have chosen the additional option **Start Delay** the symbol  is displayed.

Extra Care

- i** If you have chosen the option **Extra Care**, the **Low Heat**  indicator light illuminates. Pressing the **Low Heat**  button cancels the additional option **Extra Care**.

- i** If you have chosen the additional option **Extra care** the symbol  is displayed.

Safety guard

This additional option allows you to lock your settings to prevent unintended use of the dryer.

To start the dryer when the Safety guard is active:

- Press and hold the **Start/Pause** button for 4 seconds.

To unlock this additional option when the dryer is running:

- Press and hold the **Start/Pause** button for 4 seconds.



- i** When the dryer is running and the **Safety guard** is active, the dryer can be stopped by pressing the **Start/Pause** button for 4 seconds.

- i** If you have chosen the additional option **Safety guard** the symbol  is displayed.

Degree of dryness

The residual moisture can be individually reduced in 3 steps.

1, 2, 3: programs are lengthened

- i** If you have chosen the steps 1 to 3 of the additional option **Degree of dryness** the symbol  is displayed. **0** is standard setting – symbol  is not displayed.

Volume of the signal

Your dryer outputs different signals.

Signal	Type	Comment
Start	Short tone	Adjustable volume
Iron Dry	Sequence of medium length tones	Adjustable volume
End	Sequence of short tones	Adjustable volume
Mal-operation	Sequence of long tones	Adjustable volume
Warning of mal-function	Sequence of long tones	Maximum volume

You can change the volume of the adjustable signals:

 Press and hold the **Select** button.



 off

 increasingly

 maximum

Spin Speed

To optimize the remaining time display, the spin speed at which the laundry was previously spun in the washing machine can be entered.

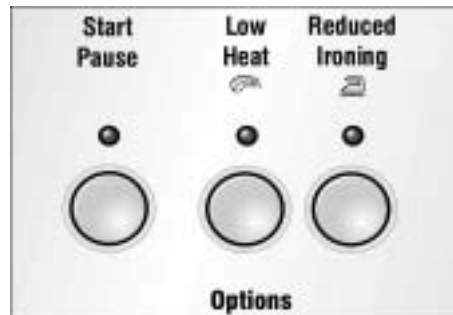

 The  symbol is only displayed for adjustment.

Options



Low Heat

Press the **Low Heat**  button for temperature-sensitive textiles. Observe the care information or symbols on the textiles. The temperature of the drying process is reduced, the drying time is extended.

 For textiles which are especially temperature sensitive (e.g. foundation garments and trousers) press the **Low Heat**  button and set the additional option **Extra Care** (see Page 17), to further reduce the temperature of the drying process.

Reduced Ironing

To prevent the laundry from creasing, the dryer drum rotates at specific intervals following the drying program. Standard setting for this function is 1 hour.

If the **Reduced Ironing**  button is pressed, this function is extended to 3 hours.

The laundry remains loose and fluffy until it is removed. The laundry should be removed at the latest after this time has elapsed.

Status indicator

The dryer uses an electronic system for all programmes except the time programmes and the special **Woollens** programme. A moisture sensor continuously checks the moisture in the laundry. Drying ends automatically as soon as the selected degree of dryness has been reached.





The drum continues to rotate at specific intervals for one hour to prevent creasing.

The current state of the process and the level reached during the programme sequence is indicated via indicator lights (**Drying, Iron Dry, Cupboard Dry, Anti Crease/end**).



 If the indicator light **Anti Crease/end** illuminates when the programme selector is in **Off** position – pull the mains plug out and inform the customer service.

Program selection table

Automatic programs		
For Cottons and coloreds made of cotton or linen. Press Low Heat  button for temperature-sensitive textiles.		 Cottons up to 10 kg
Bed linen and table linen, towels	For laundry, which is to be ironed	Iron Dry *
Bed linen and table linen, towels, T-shirts, sports shirts, overalls		
T-shirts, sports shirts, dresses, trousers, overalls, underwear		
Terry towels, kitchen towels, hand towels, bed linen, underwear, cotton socks	which is not to be ironed	Cupboard Dry *
Terry towels, kitchen towels, hand towels, bed linen, underwear, cotton socks	which is not to be ironed, thick multi-ply	Very Dry
Terry bathrobes and terry bed linen	which is particularly thick or multi-ply	Extra Dry
Easy-care (drip-dry) laundry made of synthetic and blended fabric, cotton e.g. polyester Press the Low Heat  button for very temperature-sensitive textiles.		 Easy-Care up to 5 kg
	For laundry,	
Trousers, dresses, skirts, shirts, blouses, leggings, sports clothing with synthetic-rich fibers, lingerie	which is not to be or only lightly ironed	Iron Dry
Shirts, blouses, sports clothing	which is not to be ironed	Cupboard Dry
Bed linen and table linen, track suits, anoraks, blankets	which is not to be ironed, thick multi-ply	Very Dry
Mix programs		Mixed Load up to 5 kg
	For laundry,	
Mixed loads (regular, cottons, easy-care)	which is not to be ironed	Cupboard Dry
	which is not to be ironed, thick multi-ply	Iron Dry

Specials	
Suitable for woolens (machine washable). Laundry is softened but not dried Remove the laundry as soon as the programme has finished and hang it up.	Woolens Finish
To dry washable woolen textiles (e.g. sweaters, woolen pullover, skirts)	Woolens – Drying Basket + required drying time
Loads, which only need a short drying time, e.g. sportswear, (made from synthetics, cotton or mixed fabrics)	Short Programme
Breathable waterproof fabrics (Load should not exceed 1–2 pairs of trousers or 1 jacket)	Sportswear
Time programs	up to 5 kg
Pre-dried textiles with low moisture content, individual small items, e.g. bath towels, bathing suits, dish cloths. For small amounts between 100 g and 200 g (e.g. a small hand-towel), you should select a Timed Programmes . Press the Low Heat  button for temperature-sensitive textiles. – Cottons and colored garments made of cotton or linen. – Temperature sensitive textiles.	Sportswear + required drying time Warm + required drying time
Freshening or airing little worn items of clothing and drying of extreme sensitive textiles. For all textile types inclusive foam rubber (e.g. pillows, stuffed toys), plastic (e.g. shower curtains, table clothes), rubber (e.g. backed rugs), sheer nylon, polypropylene.	Cold + required drying time

* Calculated from test programmes pursuant to EN 61 121 and IEC 61 121

Operation

Using the dryer



1. Open the dryer door.



2. Check filter.

The filter should be cleaned after and before every drying process. Cleaning the filter reduces the drying time and saves energy.



3. Rotate program selector to the desired program. Select the program which corresponds to the laundry in the dryer from the program selection table (see Page 19). The dryer light turns on inside the drum.

i The estimated remaining time will be indicated.



4. Select **Additional Options** on the display. More detailed information on the individual additional options can be found on Page 17.

5. If required, select **Options** by pressing the button. The **Options** are explained on Page 18.

i The estimated remaining time will be updated.



6. Place laundry in the empty drum. Put each piece of laundry into the machine separately.

For best results the laundry to be dried must be sorted according to type of laundry and desired degree of drying. For further information see Page 15.

i Observe drying symbols of the laundry manufacturer. If drying woolen clothing and shoes, see the information on Page 18 and Page 22.

Ensure that there is only laundry in the drum. Check that all items are completely in the drum.

7. Close the door. The **Start/Pause** indicator light continues to flash.

i If you have chosen a time program don't forget to select a time. Otherwise the **Start/Pause** indicator light will not flash and the dryer will not start.

i If the door has not been closed properly, the dryer will not start.



8. Press **Start/Pause** button. The **Start/Pause** indicator light illuminates.

i The program starts with an acoustic signal (if set). If an automatic program has been selected, the indicator lights indicate the progress of the program sequence.

i At the end of the **Anti Crease/end** programme sequence, an acoustic signal is emitted (if set).

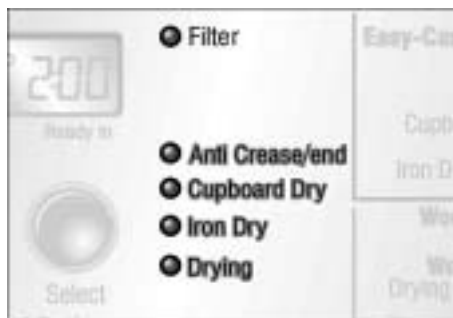

i At program end an acoustic signal is emitted (if set) and the LED **Anti Crease/end** illuminates.

i When the drying process is complete (program or selected time program ended), the drum rotates at specific intervals. This prevents the laundry from creasing (see **Reduced Ironing** ☞, see Page 18).



9. Open the dryer door.

! Drum and door may be hot!

10. Take the laundry out of the dryer.



11. Rotate the program selector to **Off**. The dryer light goes out.

12. Clean the filter. The filter should be cleaned after and before every drying process. Cleaning the filter reduces the drying time and saves energy.

13. Close the door.

Using the dryer basket

Use the dryer basket to dry washable woolen textiles (e.g. sweaters) and shoes. The dryer basket remains stationary while the drum rotates. Damp wool should not be moved, as it has a tendency to matt. Drying shoes without a basket could damage the drum. You have to use the dryer basket if you use the **Woollens Drying Basket** program.

Inserting the dryer basket

1. Open the dryer door.
2. Check that the drum is empty.



3. Remove the filter.



4. Lift the dryer basket horizontally into the drum.

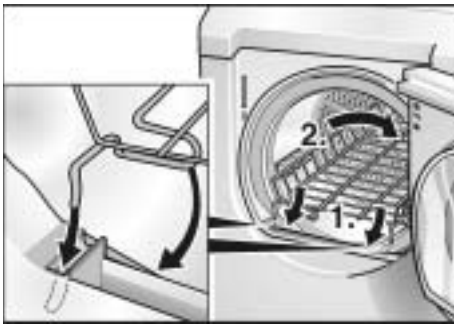

5. Place the dryer basket so that the catches are inserted at the front in the locating holes.



6. Insert the filter.
The filter must be inserted flush with the drum edge!

Drying laundry items on the dryer basket

1. Fold laundry to fit the dryer basket.



2. Place laundry loosely on the basket. Do not crush! Laundry must not touch the drum! Do not allow items to hang over the dryer basket!

3. Close the door.

4. Follow directions for time program on Page 16.



5. Rotate program selector to **Woolens Drying Basket**.

6. Select the required drying time with the **Select** button.
Select the drying time from the following table according to the laundry type.

Laundry type	Required drying time
Thin woolen pullover	80 min. (e.g. 60 + 20 min)
Thick woolen pullover	90–120 min.
Skirt	60–90 min.
Trousers	60–90 min.
Small items (e.g. gloves)	30 min.

7. If the item of clothing still contains residual moisture after the indicated drying time:

- Fold the item of clothing so that the damp parts are on the outside.
- Restart the program and reduce the drying duration depending on the degree of residual moisture.

8. After drying, spread out the laundry at air for approx. 15 min.

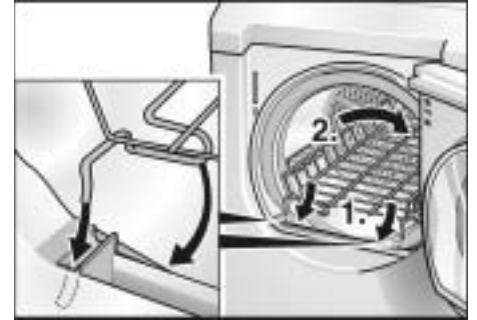

9. Take the dryer basket out of the drum.



10. Re-insert the filter.

Drying shoes on the dryer basket

1. Prepare shoes.

- Clean shoes to prevent the drum from becoming soiled.
- If preparing sports shoes, extend the tongue.
- Loosen or remove shoe-laces.
- Remove insoles and heel pads.

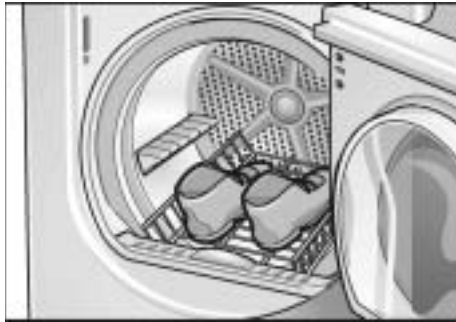

2. Place shoes on the basket.

- Directly on the dryer basket
- or

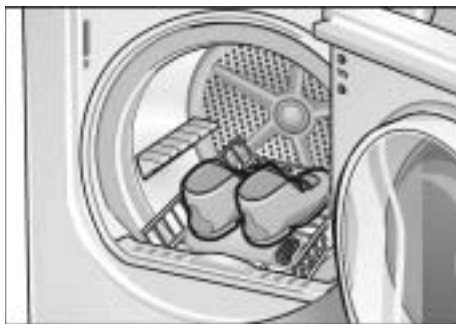

- Roll up a towel and place the heels of the shoes on the towel. This will ensure a more uniform drying result.



3. Close the door.



4. Program selector to **Timed Programmes**.

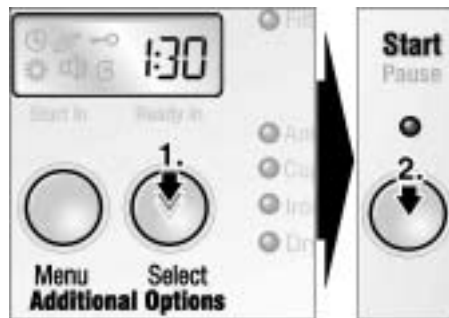

5. Select the required drying time with the **Select** button.
6. If there is still residual moisture at the end of the drying time, repeat the program.
7. At the end of the drying time take the shoes out of the dryer and leave to air for approx. 30 min.
8. Remove the filter.
9. Take the dryer basket out of the drum.
10. Re-insert the filter.

Cleaning and care

Cleaning the dryer

 The appliance must be switched off!

Only wipe the housing and the fascia with a damp cloth and soapy water. Do not use strong detergents or solvents.

Wipe the drum, door seal and inside of the door with a damp cloth only.

Cleaning the filter

A dirty filter extends the drying time and increases energy consumption.

The filter should be cleaned after and before every drying process.

If a warning signal and an E01 warning message are emitted during a drying program, or the **Filter** indicator light flashes, clean the filter immediately and check the exhaust duct.

 The program interrupts automatically.

1. Switch off the dryer. Program selector to **Off**.

 Drum and door may be hot!

2. Open the dryer door.



3. Remove the filter.



4. Remove lint by stroking your hand over the filter.

The filter should be lightly scrubbed twice a year with warm soapy water. The filter is cleaned when it no longer holds water. The filter must be dried thoroughly before being replaced.



5. Insert the filter.

6. Close the door.

Cleaning the exhaust duct

Inspect and clean the exhaust ducting at least once a year to prevent clogging. A partially clogged exhaust can lengthen the drying time.

- Turn the programme selector to the Off position.
- Pull out power supply plug.
- Disconnect the duct from the dryer.
- Vacuum and reconnect the duct.

Cleaning the moisture sensor

The moisture sensor has to be cleaned because a fine layer of transparent build-up is deposited on the sensors.

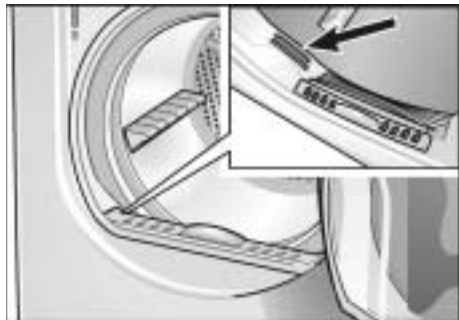

This deposit can easily be removed by wiping the sensors (the two bars next to the filter) with a cloth and a little white vinegar.

Use white vinegar only!

Clean the moisture sensor once a month.

 Do not use steel wool or abrasive materials.

Cleaning the bearing shield

Over time, fluff from the drying process collects in the bearing shield.



This fluff can be easily removed using your vacuum cleaner, at least once a month.

Change the light bulb

The dryer light turns on inside the drum when you open the door.

To change the light bulb:

- Set program selector to **Off**.
- Pull out power supply plug.
- Open the dryer door. The light is located on the upper left side of the door opening



- Loosen the screw of the cover and open the cover.
- Turn bulb counterclockwise. Replace the bulb with a new appliance bulb (only obtainable through customer service).
- Replace the cover and secure with the screw.
- Replace the mains plug into the socket.

Troubleshooting

Before calling the customer service, check whether you can rectify the fault yourself by means of the following table.

If a fault cannot be rectified or a repair is required:

1. Set program selector to **Off**.
2. Turn off the circuit breaker.
3. Pull the mains plug out of the socket.
4. Call customer service (see Page NO TAG).

Problem	Possible cause	Remedial action
Dryer does not start. Start/Pause indicator light does not illuminate.	Main plug not inserted at all or not inserted correctly.	Insert main plug correctly.
	A fuse of power supply has tripped.	Replace/switch on fuse.
	Start/Pause button not pressed.	Press Start/Pause button.
	No program selected.	Select program.
	Door not closed.	Close door.
	In Time-Programs duration not chosen.	Chose time via Select button.
	Ambient temperature below 5 °C.	Increase room temperature.
Program has been interrupted. A warning signal is emitted and the display shows E:01 and/or the Filter indicator light flashes.	Filter dirty.	Clean filter as described on Page 25. Switch off/switch on again.
	Exhaust air duct is blocked.	Clean exhaust air extraction. Switch off/switch on again.
	Fault in program sequence or malfunction.	Switch off dryer, leave to cool down for 30 min. Switch on again. Restart program.
	The room/cabinet is not adequately ventilated.	Provide an adequate supply of fresh air. Switch off/switch on again.
Drum light does not function.	No program selected.	Select program.
	Light bulb defective, light bulb burned out.	Change light bulb, see Page 26.
	No power supply.	Guarantee power supply.
	Light bulb is loose.	Tighten light bulb. Remove and reinstall the cover as directed on Page 26.
Start/Pause indicator light does not illuminate. Anti Crease/end indicator lights. The display shows 0:00 .	Fault in program sequence or malfunction.	Switch off dryer, leave to cool down for 30 min. Switch on again. Restart program.

Degree of drying has not been reached or the drying time is too long. Display may indicate E:03 .	Moisture sensor dirty.	Clean moisture sensor as described on Page 26. Switch off/switch on again.
	Exhaust air duct is blocked or too long.	Clean exhaust air extraction. Reduce exhaust air duct to maximum length as described on Page 7. Switch off/switch on again.
	Filter dirty.	Clean filter as described on Page 25. Switch off/switch on again.
	Laundry was too wet.	Spin laundry at higher speed in the washing machine. Switch off/switch on again.
	Unsuitable program selected.	Select program with aid of the Program selection table (see Page 19). Switch off/switch on again.
	Maximum drying time was exceeded.	Clean filter (see Page 25). Check exhaust air extraction. Spin laundry at a higher speed in your washer.
	Motor limit temperature was exceeded.	Switch off dryer, leave to cool down for 30 min. Switch on again. Start program.
	Degree of dryness not correct set.	Change settings for degree of dryness, see Page 17.

appliances available in the Kleenmaid range

the best products we can find.

We search the globe for products that meet our high standards of functionality, style and quality and are proud of our innovative range sourced from countries throughout the world.

Washing Machines
Dryers
Dishwashers
Ovens
Cooktops
Outdoor Cooking Centres
Built-In Coffee Machines
Rangehoods

Freestanding Ovens and Cooktops
Sinks
Waste Disposals
Taps
Cookware
Refrigerators
Wine Cellars
Vacuum Cleaners

To find your nearest Kleenmaid Showroom telephone 13 13 08
or visit www.kleenmaid.com

Warranty and Service

Warranty Registration

Please complete warranty details below. Please retain together with your proof of purchase document. These documents will need to be viewed by our Service Representative should you request in warranty service.

Service Assistance

To assist you when phoning our After Sales Service number to arrange a service call please complete the following details and have them ready when you call.

Model Number _____ Date of purchase _____

Kleenmaid Store purchased from _____ Date of installation _____

KLEENMAID AFTER SALES SERVICE

Phone: 1300 652 100

Postal: PO Box 5560

Spare Parts: 1800 025 139

Maroochydore BC, QLD 4558

Email: service@kleenmaid.com

 **Kleenmaid**
The best you can own.

9000 315 744 aus (8712)
630N