

Side by Side Refrigerators

Safety Instructions2-4
For Australia and New Zealand ...35

Operating Instructions

Additional Features11
Automatic Icemaker13
Care and Cleaning15, 16
Crispers and Pans12
CustomCool™6, 7
Ice and Water Dispenser14, 15
Refrigerator Doors11
Replacing the Light Bulbs17
Shelves and Bins9, 10
Temperature Controls5
Water and FreshSaver™ Filters ...8

Installation Instructions

For Australia and
New Zealand36-38
Preparing to Install
the Refrigerator24, 25
Removing and Replacing Doors ...23
Trim Kits and Panels18-22
Water Line Installation26-30

Troubleshooting Tips32-34
Normal Operating Sounds31

Owner's Manual and Installation

Models 21, 23, 25, 27, and 29

Côte à Côte Réfrigérateurs

Manuel d'utilisation et d'installation

La section française commence à la page 40

Lado a Lado Frigoríficos

Manual del propietario e instalación

La sección en español empieza en la página 74

Write the model and serial numbers here:

Model # _____

Serial # _____

Find these numbers on a label inside
the refrigerator compartment at the
top on the right.

IMPORTANT SAFETY INFORMATION. READ ALL INSTRUCTIONS BEFORE USING.

⚠ WARNING!

Use this appliance only for its intended purpose as described in this Owner's Manual.



SAFETY PRECAUTIONS

When using electrical appliances, basic safety precautions should be followed, including the following:

- This refrigerator must be properly installed and located in accordance with the Installation Instructions before it is used. Also see the *How to Connect Electricity* section.
- Do not attempt to stand on top of the refrigerator. Doing so may result in bodily injury or damage to the refrigerator.
- Do not allow children to play with the refrigerator or tamper with the controls.
- Do not allow children to climb, stand or hang on the shelves in the refrigerator. They could damage the refrigerator and seriously injure themselves.
- Do not touch the cold surfaces in the freezer compartment when hands are damp or wet. Skin may stick to these extremely cold surfaces.
- Do not store or use gasoline or other flammable vapors and liquids in the vicinity of this or any other appliance.
- In refrigerators with automatic icemakers, avoid contact with the moving parts of the ejector mechanism, or with the heating element located on the bottom of the icemaker. Do not place fingers or hands on the automatic icemaking mechanism while the refrigerator is plugged in.
- Installation of the icemaker must be done by a qualified service technician.
- Keep fingers out of the “pinch point” areas; clearances between the doors and between the doors and cabinet are necessarily small. Be careful closing doors when children are in the area.
- Unplug the refrigerator before cleaning and making repairs.
NOTE: We strongly recommend that any servicing be performed by a qualified individual.
- **Before replacing a burned-out light bulb, the refrigerator should be unplugged** in order to avoid contact with a live wire filament. (A burned-out lightbulb may break when being replaced.)
NOTE: Setting either or both controls to **0** (off) does not remove power to the light circuit.
- Do not refreeze frozen foods which have thawed completely.
- Always clean the **CustomCool™** Tray after thawing food.

⚠ DANGER! RISK OF CHILD ENTRAPMENT

PROPER DISPOSAL OF THE REFRIGERATOR

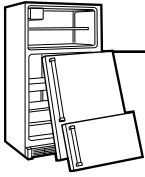

Child entrapment and suffocation are not problems of the past. Junked or abandoned refrigerators are still dangerous...even if they will sit for “just a few days.” If you are getting rid of your old refrigerator, please follow the instructions below to help prevent accidents.

Before You Throw Away Your Old Refrigerator or Freezer:

- Take off the doors and discard separately.
- Leave the shelves in place so that children may not easily climb inside.
- If the refrigerator has a lock, make it unusable.

CFC Disposal

Your old refrigerator may have a cooling system that used CFCs (chlorofluorocarbons). CFCs are believed to harm stratospheric ozone.

If you are throwing away your old refrigerator, make sure the CFC refrigerant is removed for proper disposal by a qualified servicer. If you intentionally release this CFC refrigerant you can be subject to fines and imprisonment under provisions of environmental legislation.

IMPORTANT SAFETY INFORMATION. READ ALL INSTRUCTIONS BEFORE USING.

⚠ WARNING!



HOW TO CONNECT ELECTRICITY

The power cord of this appliance is equipped with an earthing plug which mates with a standard earthed wall outlet to minimize the possibility of electric shock hazard from this appliance.

Have the wall outlet and circuit checked by a qualified electrician to make sure the outlet is properly earthed.

Where an unearthed wall outlet is encountered, it is your personal responsibility and obligation to have it replaced with a properly earthed wall outlet.

The refrigerator should always be plugged into its own individual electrical outlet. This provides the best performance and also prevents overloading house wiring circuits which could cause a fire hazard from overheated wires. Please refer to the rating plate on the refrigerator for the correct voltage, wattage and frequency. If the product plug does not fit your outlet, the product should be fitted with a new plug.

Insure proper earthing exists before using.

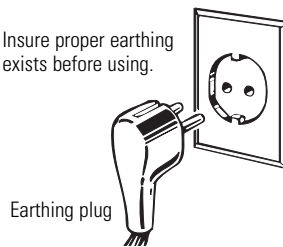

IMPORTANT: The refitting of electric plugs and cables should be done by a qualified technician or service agent. In some countries the refitting of electric plugs and cables is only permitted when the work is completed by a qualified technician.

If the power supply cord becomes damaged, it must be replaced by a qualified service agent in order to avoid a safety hazard.

Never unplug your refrigerator by pulling on the power cord. Always grip plug firmly and pull straight out from the outlet.

Repair or replace immediately all power cords that have become frayed or otherwise damaged. Do not use a cord that shows cracks or abrasion damage along its length or at either end.

When moving the refrigerator away from the wall, be careful not to roll over or damage the power cord.

Mains lead replacement

If the mains lead on your refrigerator needs replacing at any time, it must be replaced by a special lead which is obtainable from your local dealer. A charge will be made for the replacement of the mains lead if you have damaged the lead.

The refrigerator must be positioned so that the plug is accessible.



READ AND FOLLOW THIS SAFETY INFORMATION CAREFULLY.

SAVE THESE INSTRUCTIONS

About the temperature controls on CustomCool™ models.

(for other models, see next page)

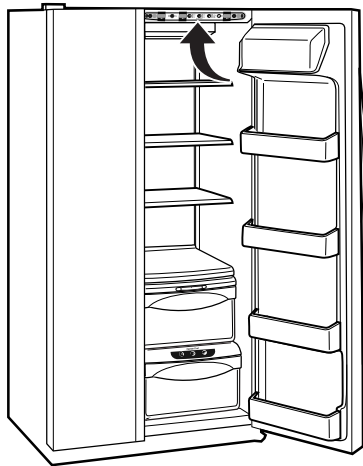
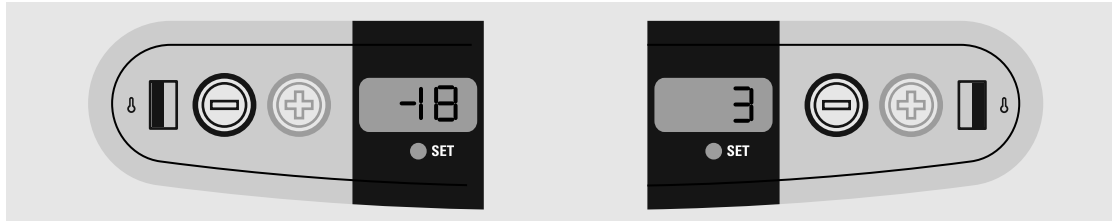

The temperature controls are preset in the factory at **3°C** for the refrigerator compartment and **-18°C** for the freezer compartment. Allow 24 hours for the temperature to stabilize to the preset recommended settings.

The temperature controls can display both the **SET** temperature as well as the actual temperature in the refrigerator and freezer. The actual temperature may vary slightly from the **SET** temperature based on usage and operating environment.

Setting either or both controls to **0** (off) stops cooling in both the freezer and refrigerator compartments, but does not shut off electrical power to the refrigerator.

NOTE: The refrigerator is shipped with protective film covering the temperature controls. If this film was not removed during installation, remove it now.

To change the temperature, press and release the **+** or **-** pad. The **SET** light will come on and the display will show the set temperature. To change the temperature, tap either the **+** or **-** pad until the desired temperature is displayed. Refrigerator temperatures can be adjusted between 1°C and 7°C and the freezer temperatures can be adjusted between -21°C and -14°C.

Once the desired temperature has been set, the temperature display will return to the actual refrigerator and freezer temperatures after 5 seconds. Several adjustments may be required. Each time you adjust controls, allow 24 hours for the refrigerator to reach the temperature you have set.

To turn the cooling system off, tap the **+** pad for either the refrigerator or the freezer until the display shows **0** (off). **To turn the unit back on,** press the **-** pad for either the refrigerator or freezer. The **SET** light will illuminate on the side you selected. Then press the **-** pad again (on the side where the **SET** light is illuminated) and it will go to the preset points of **-18°C** for the freezer and **3°C** for the refrigerator. Setting either or both controls to **0** (off) stops cooling in both the freezer and refrigerator compartments, but does not shut off electrical power to the refrigerator.

Ambient Room Temperature Limits

This refrigerator is designed to operate in ambient temperatures specified by its Temperature Class which is marked on the rating plate.

Temperature Class	Symbol	Ambient Temperature	
		Maximum	Minimum
Extended-Temperate	SN	32°C	10°C
Temperate	N	32°C	16°C
Subtropical	ST	38°C	18°C
Tropical	T	43°C	18°C

NOTE: Internal temperature may be affected by such factors as the location of the refrigerator, ambient temperature and frequency of door openings. Adjust temperature controls as required to compensate for these factors.

About the temperature controls.

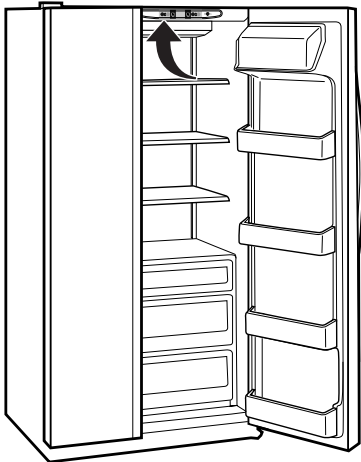

The temperature controls are preset in the factory at **5** for both the refrigerator and freezer compartments. allow 24 hours for the temperature to stabilize to the preset settings.

Several adjustments may be required. Each time you adjust controls, and allow 24 hours after each adjustment for the refrigerator to reach the temperature you have set.

Setting either or both controls to **0** stops cooling in both the freezer and refrigerator compartments but does not shut off electrical power to the refrigerator.

Control settings will vary based on personal preferences, usage, and operating conditions and may require more than one adjustment.

NOTE: The refrigerator is shipped with protective film covering the temperature controls. If this film was not removed during installation, remove it now.

Ambient Room Temperature Limits

This refrigerator is designed to operate in ambient temperatures specified by its Temperature Class which is marked on the rating plate.

Temperature Class	Symbol	Ambient Temperature	
		Maximum	Minimum
Extended-Temperate	SN	32°C	10°C
Temperate	N	32°C	16°C
Subtropical	ST	38°C	18°C
Tropical	T	43°C	18°C

NOTE: Internal temperature may be affected by such factors as the location of the refrigerator, ambient temperature and frequency of door openings. Adjust temperature controls as required to compensate for these factors.

About CustomCool™ (on some models).

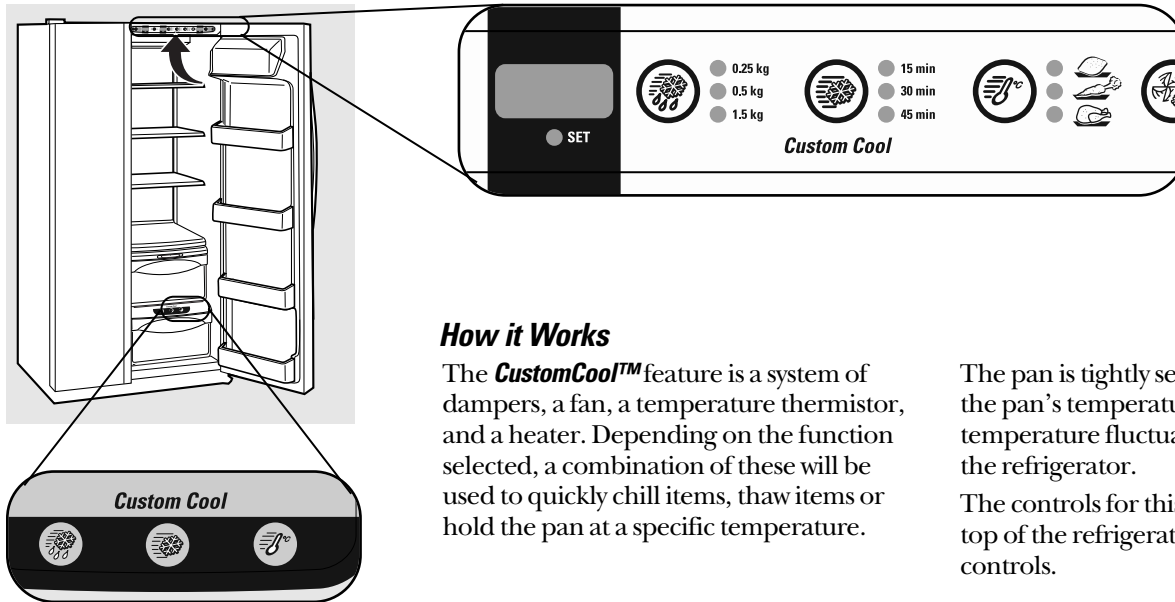

How it Works

The **CustomCool™** feature is a system of dampers, a fan, a temperature thermistor, and a heater. Depending on the function selected, a combination of these will be used to quickly chill items, thaw items or hold the pan at a specific temperature.

The pan is tightly sealed to prevent the pan's temperature from causing temperature fluctuations in the rest of the refrigerator.

The controls for this pan are located at the top of the refrigerator with the temperature controls.

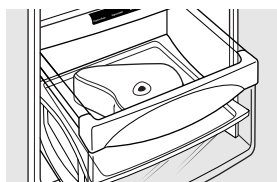

ExpressThaw™

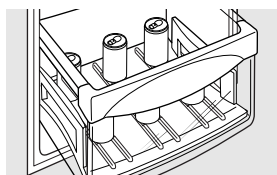

ExpressChill™

How to Use

1 Empty the pan. Place the Chill/Thaw tray in the pan with the metal plate facing down to chill and store items, or with the metal plate facing up to thaw items. Place the items on the tray and close the pan completely.

2 Select the **ExpressThaw™**, **ExpressChill™** or **SelectTemp™** pad. The display and **SET** light will come on. Tap the pad until the light appears next to the desired setting. Use the chart to determine the best setting to use.

- To stop a feature before it is finished, tap that feature's pad until no options are selected and the display is off.
- During **ExpressThaw™** and **ExpressChill™**, the display on the controls will count down the time in the cycle.

- After the **ExpressThaw™** cycle is complete, the pan will reset to the **MEAT** setting (-1°C) to help preserve thawed items until they are used.
- The displayed actual temperature of the **CustomCool** pan may vary slightly from the **SET** temperature based on usage and operating environment.

NOTE: For food safety reasons, it is recommended that foods be wrapped in plastic wrap when using **ExpressThaw™**. This will help contain meat juices and improve thawing performance.

About CustomCool™ (on some models).

CustomCool™ Chart

NOTE: Results may vary depending on packaging, starting temperature, and other food traits.



ExpressThaw

0.25 kg (4 hours)

- Hamburgers (0.2 kg)
- Individually Wrapped Filet Mignon (0.2 kg)

0.5 kg (8 hours)

- Chicken Breasts (0.7 kg)
- Minced Beef (0.7 kg)
- Steak (0.7 kg)

1.5 kg (12 hours)

- Chicken Breasts (1.4 kg)
- Minced Beef (1.4 kg)
- Steak (1.4 kg)



ExpressChill

15 Minutes

- 1 Beverage Can (355 ml)
- 2 Small Juice Boxes (175–240 ml each)

30 Minutes

- 2 to 6 Beverage Cans (355 ml each)
- 2 Plastic 590 ml Bottles of Beverage
- 4 to 6 Small Juice Boxes (175–240 ml each)
- 3 Foil Juice Packets
- Wine (750 ml bottle)

45 Minutes

- 2 Liter of Beverage
- 1.9 Liters of Juice
- Gelatin – 1 package



SelectTemp

Citrus Setting (6°C)

- Oranges, Lemons, Limes, Pineapple, Cantaloupe
- Beans, Cucumbers, Tomatoes, Peppers, Aubergine, Squash

Produce Setting (1°C)

- Strawberries, Raspberries, Kiwifruit, Pears, Cherries, Blackberries, Grapes, Plums, Nectarines, Apples
- Asparagus, Broccoli, Corn, Mushrooms, Spinach, Cauliflower, Kale, Green Onion, Beetroot, Onions

Meat Setting (-1°C)

- Raw Meat, Fish and Poultry

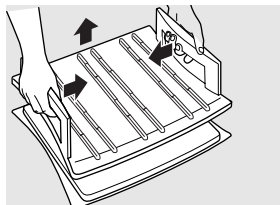

Disassembling the Chill/Thaw tray

About the CustomCool™ Pan Rack and Tray

To clean the Chill/Thaw tray, disassemble the metal tray from the plastic stand by lightly pushing in on the handles of the plastic stand and removing the metal tray. Both the metal tray and the plastic stand are dishwasher safe.

To reassemble the tray, place the plastic stand upside down (handles on bottom) on a solid surface. Place the metal plate on top of the stand matching up the curved side of the plate with the curved side of the stand. Insert one side of the plate into the notches on the stand. Push in on the handle on the other side of the stand while pushing that end of the plate down and into place. You should hear the plate “click” into place.



Turbo Cool

When you need the refrigerator cooled in a hurry, press this pad to cool the refrigerator at the maximum rate. This feature will continue to operate for eight hours after being activated.

About the water and FreshSaver™ filters.

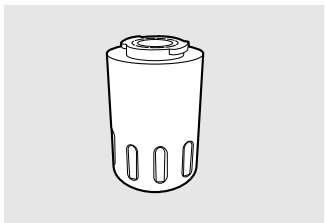

Water Filter Cartridge (on some models)

The water filter cartridge is located in the back upper right corner of the refrigerator compartment.

When to Replace the Filter

There is a replacement indicator light for the water filter cartridge on the dispenser. This light will turn orange to tell you that you need to replace the filter soon.

The filter cartridge should be replaced when the replacement indicator light turns red or if the flow of water to the dispenser or icemaker decreases.

Installing the Filter Cartridge

- 1 If you are replacing the cartridge, first remove the old one by slowly turning it to the left. **Do not** pull down on the cartridge. A small amount of water may drip down.
- 2 Fill the replacement cartridge with water from the tap to allow for better flow from the dispenser immediately after installation.
- 3 Lining up the arrow on the cartridge and the cartridge holder, place the top of the new cartridge up inside the holder. **Do not** push it up into the holder.

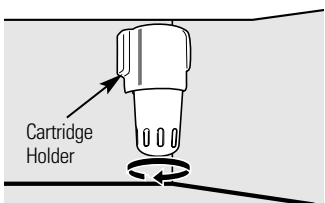

Place the top of the cartridge up inside the cartridge holder and slowly turn it to the right.

Slowly turn it to the right until the filter cartridge stops. **DO NOT OVERTIGHTEN.** As you turn the cartridge, it will automatically raise itself into position. Cartridge will rotate about 1/4 turn.

- 5 Run water from the dispenser for 3 minutes (about six liters) to clear the system and prevent sputtering.

- 6 Press and hold the **RESET WATER FILTER** pad on the dispenser for 3 seconds.

NOTE: A newly-installed water filter cartridge may **cause water to spurt** from the dispenser.

Filter Bypass Plug

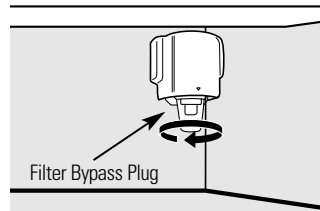

You must use the filter bypass plug when a replacement filter cartridge is not available. The dispenser and the icemaker will not operate without the filter or filter bypass plug.

Replacement Filters:

To order additional filter cartridges, contact your local distributor.

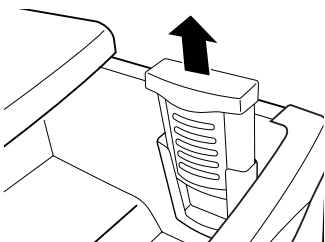

FreshSaver™ Filter (on some models)

This filter is located inside the fresh produce drawer. The filter should last approximately eight years.

About the refrigerator doors.

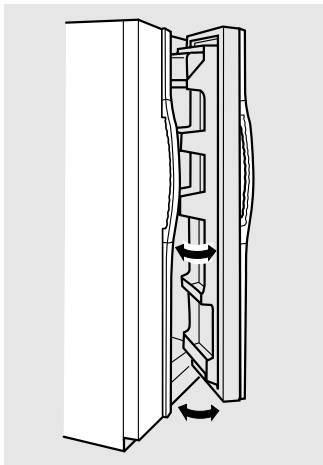

Refrigerator Doors

The refrigerator doors may feel different than the ones you are used to. The special door opening/closing feature makes sure the doors close all the way and are securely sealed.

When opening and closing the door you will notice a **stop** position. If the door is opened past this **stop** point, the door will remain open to allow you to load and unload food more easily. When the door is only partially open it will automatically close.

The resistance you feel at the **stop** position will be reduced as the door is loaded with food.

When the door is only partially open it will automatically close.

Beyond this **stop** the door will stay open.

About the shelves and bins.

Not all features are on all models.

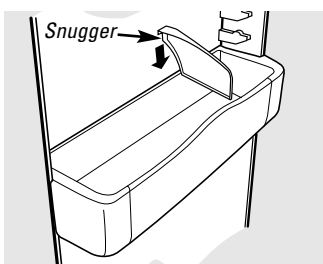

Refrigerator bin

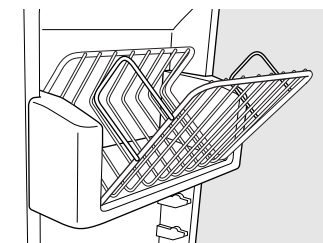

Freezer tilt-out bin

Refrigerator Door Bins and Freezer Door Tilt-Out Bins

Large Bins

The larger refrigerator door bins and freezer tilt-out door bins are adjustable.

To remove: Lift the front of the bin straight up, then lift up and out.

To replace or relocate: Engage the back side of the bin in the molded supports of the door. Then push down on the front of the bin. Bin will lock in place.

Small Bins

To remove: Lift the front of the bin straight up then out.

To replace: Position the bin above the rectangular molded supports on the door. Then slide the bin down onto the support to lock it in place.

The snagger helps prevent tipping, spilling or sliding of small items stored on the door shelf. Place a finger on either side of the snagger near the rear and move it back and forth to fit your needs.

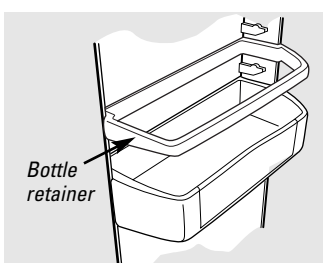

Bottle retainer

Bottle Retainer

The bottle retainers are adjustable and keep tall items from tipping over.

To remove: Lift the front of the retainer straight up, then lift it up.

To replace or relocate: Engage the back of the bottle retainer in the molded supports on the door. Then push down on the front of the bottle retainer.

About the shelves and bins.

Not all features are on all models.

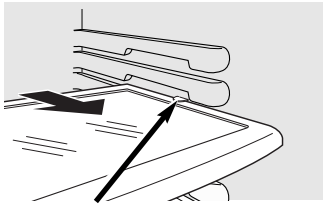

Press tab and pull shelf forward to remove

Slide-Out Spillproof Shelf

The slide-out spillproof shelf allows you to reach items stored behind others. The special edges are designed to help prevent spills from dripping to lower shelves.

To remove:

Slide the shelf out until it reaches the stop, then press down on the tab and slide the shelf straight out.

To replace or relocate:

Line the shelf up with the supports and slide it into place. The shelf can be repositioned when the door is at 90° or more. To reposition the shelf, slide the shelf past the stops and angle downward. Slide shelf down to the desired position, line up with the supports and slide into place.

Make sure you push the shelves all the way back in before you close the door.

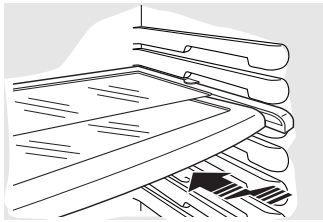
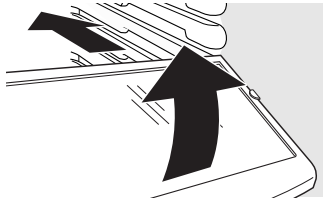

QuickSpace™ Shelf

This shelf splits in half and slides under itself for storage of tall items on the shelf below.

This shelf can be removed and replaced or relocated just like Slide-Out Spillproof Shelves.

On some models, this shelf can not be used in the lowest position.

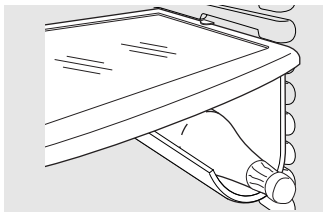

Removable Beverage Rack

The beverage rack is designed to hold a bottle on its side. It can be attached to any slide-out shelf.

To install:

- 1 Line up the large part of the slots on the top of the rack with the tabs under the shelf.
- 2 Then slide the rack back to lock it in place.

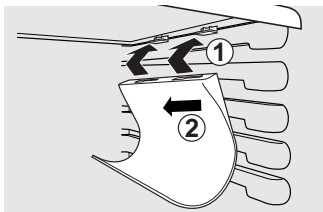

About the shelves and bins.

Not all features are on all models.

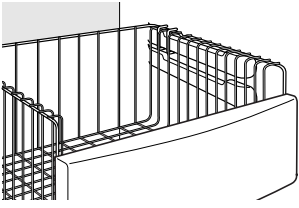

Deep Freezer Baskets

To remove, push the basket all the way to the back of the freezer. Lift up until the back pins are disengaged. Lift the entire basket up and pull out.

Make sure you push the baskets all the way back in before you close the door.

WARNING: Poor performance may occur if freezer baskets are not used. Storage of items in the freezer without using baskets may result in poor temperature performance due to restrictions of air flow within the freezer compartment.

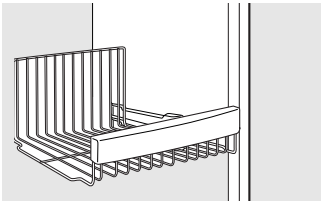

Freezer Baskets

To remove, slide out to the **stop** position, lift the front past the stop position, and slide out.

Make sure you push the baskets all the way back in before you close the door.

WARNING: Poor performance may occur if freezer baskets are not used. Storage of items in the freezer without using baskets may result in poor temperature performance due to restrictions of air flow within the freezer compartment.

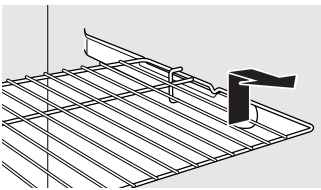

Slide-Out Freezer Shelves

To remove, slide out to the **stop** position, lift the front past the stop position, and slide out.

Make sure you push the shelves all the way back in before you close the door.

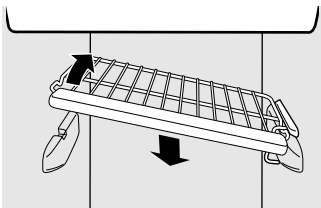

Fixed Freezer Shelves

To remove, lift the shelf up at the left side and then bring the shelf out.

About the freezer compartment.

Loading the Freezer Compartment

Load so that at least 15 mm of space remains clear between stacks of packages and 15 mm to 25 mm of space between the top of any stack and any shelf or basket above it. Packages may hang over the front of shelves but must remain 15 mm from doors.

- Food to be frozen must not be placed in direct contact with food in storage. If food is to be frozen every day, it may be necessary to reduce the quantity to be frozen.
- If a quantity of food needs to be frozen, set the freezer control to its coldest setting. After the food is frozen, reset the freezer control to its initial position.
- Food is most quickly frozen on the middle three shelves of the freezer compartment and most slowly in the freezer door shelves.



- Do not store commercially quick-frozen food longer than the time recommended by the food manufacturers.
- If the power to the appliance is shut off for an extended time or if the refrigerating system fails, do not open the doors unless absolutely necessary. When it is necessary, close them as quickly as possible so the frozen food will stay frozen as long as possible.
- The freezer door storage shelves marked with a two-star label are only appropriate for the storage of previously frozen food.

Effervescent drinks should not be stored in the freezer compartment.

Freezer Performance

This Refrigerator/Freezer has an overall “Four Star”  rating.

Freezer performance is classified by star ratings defined by ISO 8561 STANDARD AND SUMMARY BELOW:

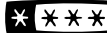
CODE	FREEZING-LOAD TEMP. (FOOD TEMPERATURE)
	Below -6°C.
	Below -12°C.
 or 	Below -18°C.

However, these limited areas have a two star rating as permitted by the standard:

Models	Location of  Freezer Shelves
21, 23 with dispenser	Bottom freezer basket and bottom 2 door shelves, top freezer door shelf.
25 with dispenser	Shelf above the ice bucket, top freezer door shelf and bottom 2 door shelves.
25 without dispenser	Shelf above the ice bucket, top freezer door shelf and bottom 2 door shelves.
27 with dispenser	Shelf above the ice bucket, top freezer door shelf and bottom 2 door shelves.
29 with dispenser	Bottom 2 freezer door shelves.

About the crispers and pans.

Not all features are on all models.

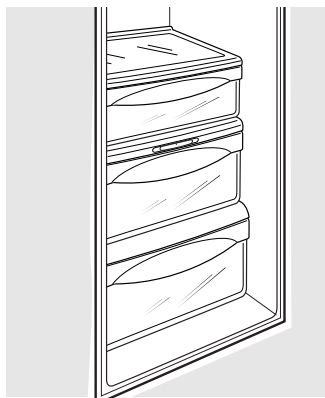

Fruit and Vegetable Crispers

Excess water that may accumulate in the bottom of the drawers should be wiped dry.

On some models the bottom drawer has a cover that slides back as the drawer is opened. This allows full access to the drawer. As the drawer is closed, the cover will slide forward into its original position.

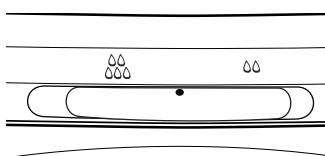

Adjustable Humidity Crispers

Slide the control all the way to the ☉ (high) setting to provide high humidity recommended for most vegetables.

Slide the control all the way to the ☾ (low) setting to provide lower humidity levels recommended for most fruits.

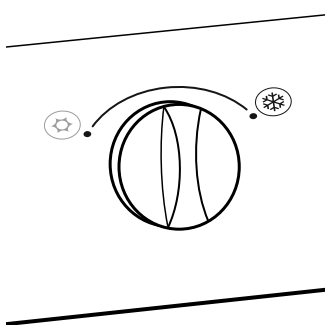

Convertible Meat Pan

The convertible meat pan has its own cold air duct to allow a stream of cold air from the freezer compartment to flow to the pan.

The variable temperature control regulates the air flow from the Climate Keeper™.

Set the control to the ❄️ (coldest) setting to store fresh meats.

Set the control to ❄️ (cold) to convert the pan to normal refrigerator temperature and provide extra vegetable storage space. The cold air duct is turned off. Variable settings between these extremes can be selected.

About crisper removal.

Not all features are on all models.

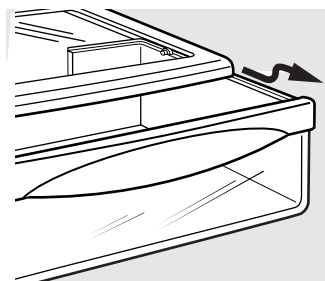

Crisper Removal

Crispers can easily be removed by pulling the drawer straight out and lifting the drawer up and over the **stop** location.

If the door prevents you from taking out the drawers, first try to remove the door bins. If this does not offer enough clearance, the refrigerator will need to be rolled forward until the door opens enough to slide the drawers out. In some cases, when you roll the refrigerator out, you will need to move the refrigerator to the left or right as you roll it out.

About the automatic icemaker.

A newly-installed refrigerator may take 12 to 24 hours to begin making ice.

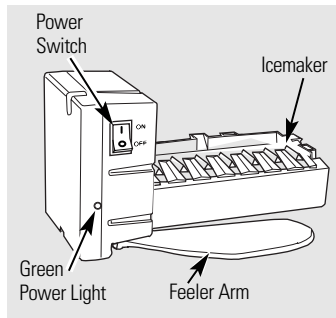

Automatic Icemaker

The icemaker will produce seven cubes per cycle—approximately 100–130 cubes in a 24-hour period, depending on freezer compartment temperature, room temperature, number of door openings and other use conditions.

To access the icemaker: Pull the shelf above the ice drawer straight out. Always be sure to replace the shelf.

If the refrigerator is operated before the water connection is made to the icemaker, set the power switch in the **O** position.

When the refrigerator has been connected to the water supply, set the power switch to the **I** position.

The icemaker will fill with water when it cools to -10°C . A newly-installed refrigerator may take 12 to 24 hours to begin making ice cubes.

Throw away the first few batches of ice to allow the water line to clear.

Be sure nothing interferes with the sweep of the feeler arm.

When the bin fills to the level of the feeler arm, the icemaker will stop producing ice. It is normal for several cubes to be joined together.

If ice is not used frequently, old ice cubes will become cloudy, taste stale and shrink.

If ice cubes get stuck in the icemaker, the green power light will blink. To correct this, set the power switch to **O** and remove the cubes. Set the power switch to **I** to restart the icemaker. After the icemaker has been turned on again, there will be a delay of about 45 minutes before the icemaker resumes operation.

NOTE: In homes with lower-than-average water pressure, you may hear the icemaker cycle multiple times when making one batch of ice.

⚠ WARNING: Connect to potable water supply only. **Installation of the icemaker must be done by a qualified service technician.**

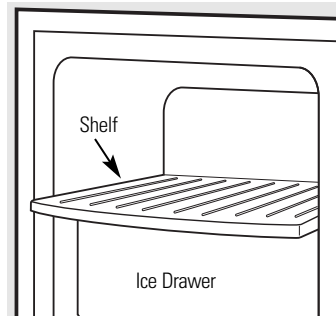

Pull the upper freezer shelf straight out to access the icemaker. Always be sure to replace the shelf. The shelf can be used for storage.

Ice Storage Drawer

To access ice, pull the drawer forward.

To remove the drawer, pull it straight out and lift it past the **stop** location.

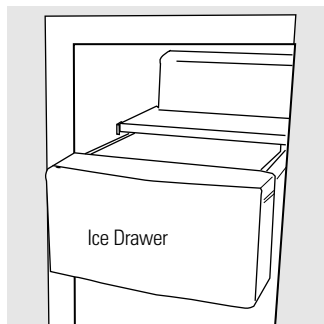

About the ice and water dispenser (on some models).



To Use the Dispenser

Select **CUBED ICE** , **CRUSHED ICE**  or **WATER** .

Press the glass gently against the top of the dispenser pad/cradle.

The spill shelf is not self-draining. To reduce water spotting, the shelf and its grille should be cleaned regularly.

If no water is dispensed when the refrigerator is first installed, there may be air in the water line system. Press the dispenser pad/cradle for at least two minutes to remove trapped air from the water line and to fill the water system. To flush out impurities in the water line, throw away the first six glassfuls of water.

CAUTION: Never put fingers or any other objects into the ice crusher discharge opening.

Locking the Dispenser (on some models)

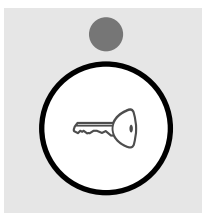

Press the **LOCK CONTROL** pad for 3 seconds to lock the dispenser and control panel. To unlock, press and hold the pad again for 3 seconds.

Dispenser Light (on some models)



This pad turns the **night light** in the dispenser on and off. The light also comes on when the dispenser pad/cradle is pressed. If this light burns out, it should be replaced with a 6 watt 12V maximum bulb.

Door Alarm (on some models)

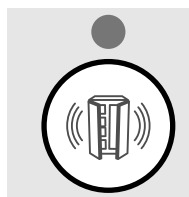

To set the alarm, press this pad until the indicator light comes on. This alarm will sound if either door is open for more than 3 minutes. The light goes out and the beeping stops when you close the door.

Important Facts About Your Dispenser

- Do not add ice from trays or bags to the storage drawer. It may not crush or dispense well.
- Avoid overfilling glass with ice and use of narrow glasses. Backed-up ice can jam the chute or cause the door in the chute to freeze shut. If ice is blocking the chute, poke it through with a wooden spoon.
- Beverages and foods should not be quick-chilled in the ice storage drawer. Cans, bottles or food packages in the storage drawer may cause the icemaker or auger to jam.
- To keep dispensed ice from missing the glass, put the glass close to, but not touching, the dispenser opening.
- Some crushed ice may be dispensed even though you selected **CUBED ICE**. This happens occasionally when a few cubes accidentally get directed to the crusher.
- After crushed ice is dispensed, some water may drip from the chute.
- Sometimes a small mound of snow will form on the door in the ice chute. This condition is normal and usually occurs when you have dispensed crushed ice repeatedly. The snow will eventually evaporate.

CAUTION: Some products such as water ices should not be consumed too cold.

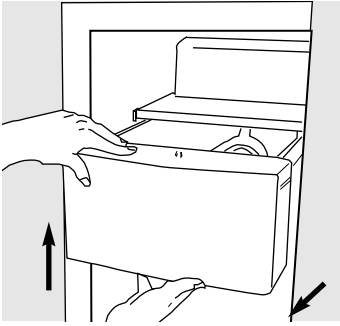

Ice Storage Drawer on Dispenser Models

To remove:

Set the icemaker power switch to the **0 (off)** position. Pull the drawer straight out and then lift past the **stop** position.

To replace:

When replacing the drawer, be sure to press it firmly into place. If it does not go all the way back, remove it and rotate the drive mechanism 1/4 turn. Then push the drawer back again.

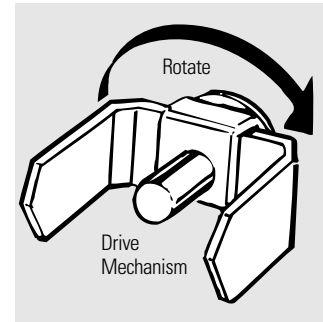

Care and cleaning of the refrigerator.

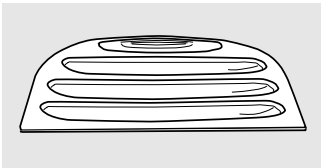

Dispenser drip area.

Cleaning the Outside

The dispenser drip area, beneath the grille, should be wiped dry. Water left in this area may leave deposits. Remove the deposits by adding undiluted vinegar to the well. Soak until the deposits disappear or become loose enough to rinse away.

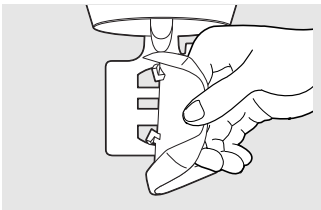

Removing the dispenser pad (on some models)

The dispenser pad/cradle (on dispenser models).

Before cleaning, open the freezer door part way to prevent dispensing of ice or water when cleaning. On models with a dispenser pad, the pad can be removed before cleaning. Simply peel the pad away from the back of the dispenser. Clean the pad/cradle with a warm water and baking soda solution—about 15 ml of baking soda to 1 liter of water. Rinse thoroughly and wipe dry.

The door handles and trim. Clean with a cloth dampened with soapy water. Dry with a soft cloth.

Keep the outside clean. Wipe with a clean cloth lightly dampened with kitchen appliance wax or mild liquid dish detergent. Dry and polish with a clean, soft cloth.

Do not wipe the refrigerator with a soiled dish cloth or wet towel. These may leave a residue that can erode the paint. Do not use scouring pads, powdered cleaners, bleach or cleaners containing bleach because these products can scratch and weaken the paint finish.

Cleaning the Inside

To help prevent odors, leave an open box of baking soda in the refrigerator and freezer compartments.

Unplug the refrigerator before cleaning. If this is not practical, wring excess moisture out of sponge or cloth when cleaning around switches, lights or controls.

Use warm water and baking soda solution—about 15 ml of baking soda to one liter of water. This both cleans and neutralizes odors. Rinse and wipe dry.

Use of any cleaning solution other than that which is recommended, especially those that contain petroleum distillates, can crack or damage the interior of the refrigerator.

Avoid cleaning cold glass shelves with hot water because the extreme temperature difference may cause them to break. Handle glass shelves carefully. Bumping tempered glass can cause it to shatter.

Do not wash any plastic refrigerator parts in the dishwasher.

Care and cleaning of the refrigerator.

Behind the Refrigerator

Be careful when moving the refrigerator away from the wall. All types of floor coverings can be damaged, particularly cushioned coverings and those with embossed surfaces.

Pull the refrigerator straight out and return it to position by pushing it straight in. Moving the refrigerator in a side direction may result in damage to the floor covering or refrigerator.

When pushing the refrigerator back, make sure you don't roll over the power cord or icemaker supply line.

Preparing for Vacation

For long vacations or absences, remove food and unplug the refrigerator. Clean the interior with a baking soda solution of 15 ml of baking soda to 1 liter of water. Leave the doors open.

Set the icemaker power switch to the **0** position and shut off the water supply to the refrigerator.

If the temperature can drop below freezing, have a qualified servicer drain the water supply system to prevent serious property damage due to flooding.

Preparing to Move

Secure all loose items such as shelves and drawers by taping them securely in place to prevent damage.

When using a hand truck to move the refrigerator, do not rest the front or back of the refrigerator against the hand truck. This could damage the refrigerator. Handle only from the sides of the refrigerator.

Be sure the refrigerator stays in an upright position during moving.

Replacing the light bulbs.

Setting the controls to **0** (off) does not remove power to the light circuit.

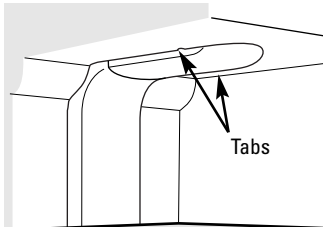

Refrigerator Compartment—Upper Light

- 1 Unplug the refrigerator.
- 2 The bulbs are located at the top of the compartment, inside the light shield. Remove the screw at the front of the light shield.
- 3 To remove the light shield, press in on the tabs on the sides of the shield and slide forward and out.
- 4 After replacing the bulb with an appliance bulb of the same or lower wattage, replace the light shield and screw. When replacing the light shield, make sure that the tabs at the back of the shield fit into the slots at the back of the light shield housing.
- 5 Plug the refrigerator back in.

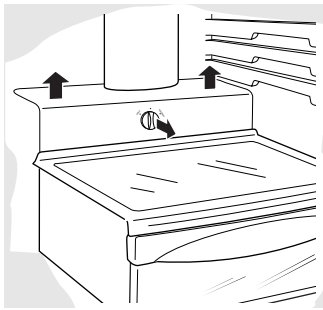

Refrigerator Compartment—Lower Light

This light is located above the top drawer.

- 1 Unplug the refrigerator.
- 2 Remove the convertible meat drawer control knob by pulling straight out.
- 3 Lift the light shield up and pull it out.
- 4 After replacing the bulb with an appliance bulb of the same or lower wattage, replace the shield and the knob.
- 5 Plug the refrigerator back in.

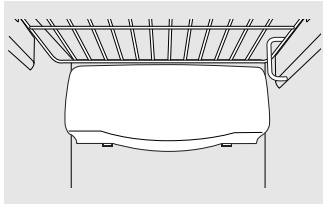

Freezer Compartment

- 1 Unplug the refrigerator.
- 2 Remove the shelf just above the light shield. (The shelf will be easier to remove if it is emptied first.) On some models, a screw at the top of the light shield will need to be removed.
- 3 To remove the light shield, press in on the sides, and lift up and out.
- 4 Replace the bulb with an appliance bulb of the same or lower wattage, and reinstall the light shield. When reinstalling the light shield, make sure the top tabs snap securely into place. Replace the screw (on some models).
- 5 Reinstall the shelf and plug the refrigerator back in.

Dispenser

- 1 Unplug the refrigerator.
- 2 The bulb is located on the dispenser under the control panel. Remove the lightbulb by turning it counterclockwise.
- 3 Replace the bulb with a bulb of the same size and wattage.
- 4 Plug the refrigerator back in.

Trim kits and decorator panels.

For Built-In Style models

Read these instructions completely and carefully.



Before You Begin

Some models are equipped with trim kits that allow you to install door panels.

Panels less than 6 mm thick

When installing wood panels less than 6 mm thick, you need to create a filler panel, such as 3 mm cardboard, that will fit between the face of the door and the wood panel. If you are installing the pre-cut decorator panels, pre-cut filler panels are included in the kit. The combined thickness of the decorator or wood panel and the filler panel should be 6 mm.

Panels 6 mm thick or less

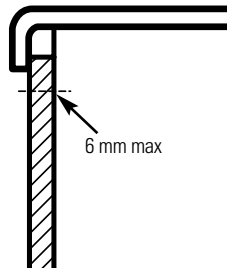

19 mm or Raised Panel

A raised panel design screwed or glued to a 6 mm thick backing, or a 19 mm routed board can be used. The raised portion of the panel must be fabricated to permit clearances of at least 5.1 cm from the handle side for fingertip clearance.

Panels thicker than 6mm, up to 19 mm max, will require that the outer 8 mm of panel perimeter be no thicker than 6 mm.

Weight limitations for custom panels:

Refrigerator Door 17 kg max.

Freezer Door 13 kg max.

Panels thicker than 6 mm

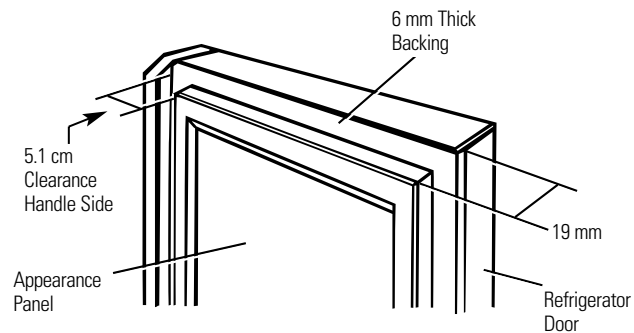
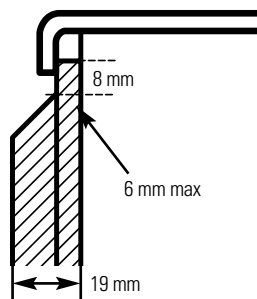

Dimensions for Custom Wood Panels

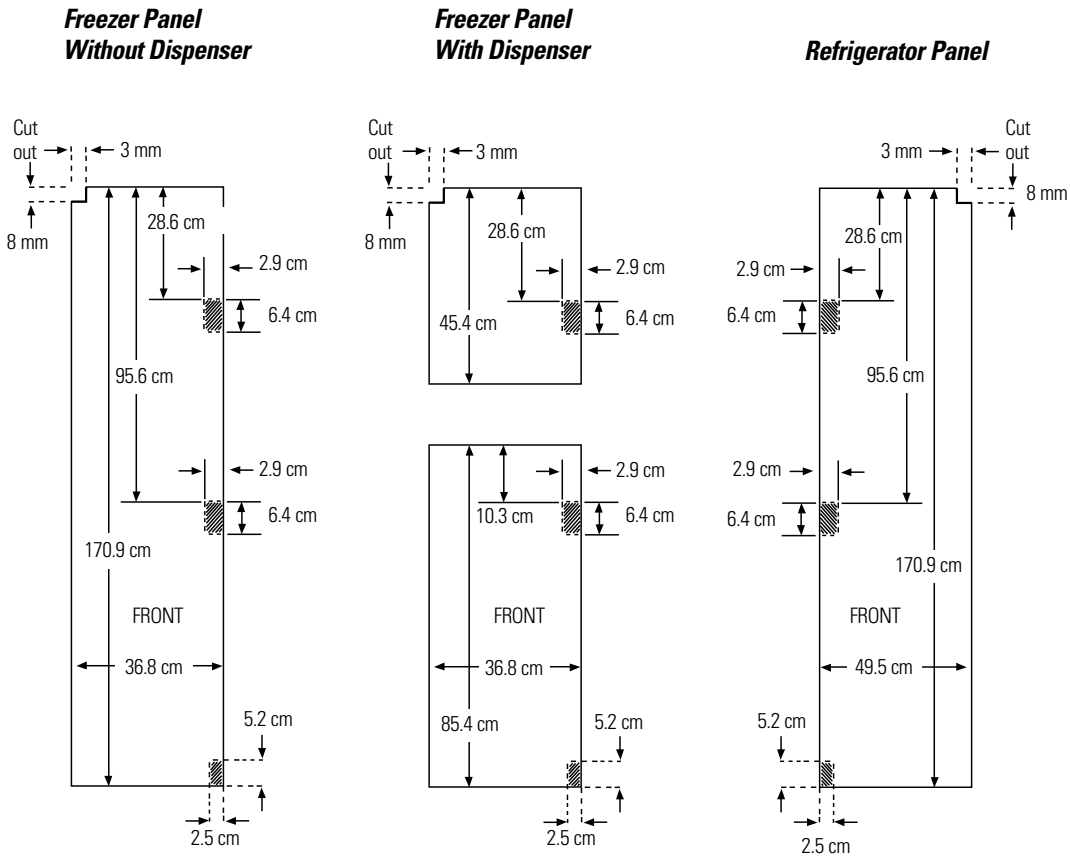

The areas at the top of the panels need to be cut out of the panels. The shaded areas indicate areas that must be routed out about 4 mm on the back side of panels 6 mm thick or more. For panels less than 6 mm thick, these areas can be cut out of the filler panels.

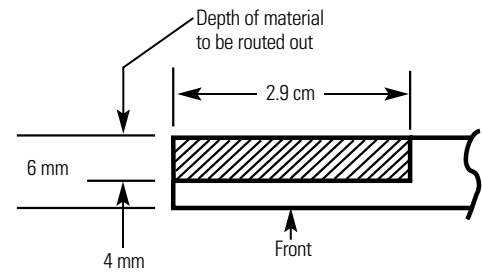

Example of Routing

Inserting the door panels.

Read these instructions completely and carefully.

1 Loosen the Top Trim on the Freezer and Refrigerator Doors.

Using a T-20 Torx driver, loosen the two screws attaching the Top Trim about 6 mm.

2 Insert the Freezer Panel and Refrigerator Panel.

Lift the Top Trim up 6 mm and carefully push the freezer panel in until it slides into the slot behind the door handle. Push the filler panel (required with some door panels) in behind the decorator panel. Repeat for refrigerator panel.

If your model has a dispenser and/or a Refreshment Center, this step only applies to the top panels.

3 Insert the Bottom Panel.

Carefully push the panel in until it slides into the slot behind the door handle. Push the filler panel (required with some door panels) in behind the decorator panel.

4 Hand tighten the two screws on the Top Trim.

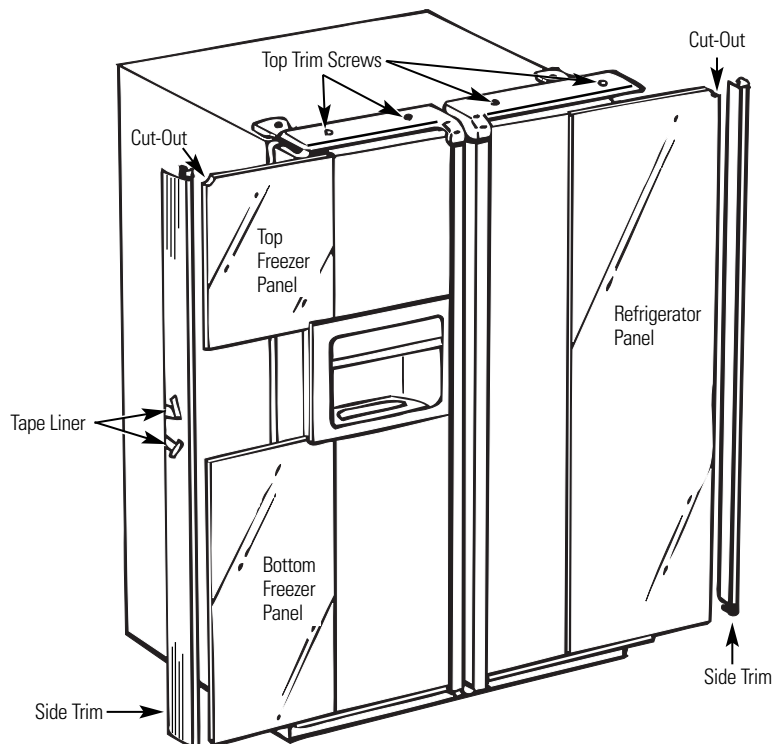

5 Install the Side Trim.

These pieces are tucked inside the refrigerator door handle.

Do not remove the protective film on the outside of the Side Trim until the Side Trim is installed.

Fit the bottom of the Side Trim under the Bottom Trim as illustrated.

Hold the Side Trim against the front face of the decorator panels and fit the Side Trim under the Top Trim. Make sure the Side Trim is fitted correctly and that you are satisfied with the appearance of all the parts before pulling the tape liner.

6 Secure the Side Trim.

Place one hand between the two pieces of tape liner and hold the Side Trim firmly against the panels and the side of the door.

Pull the top tape liner up about 80 mm, pressing the trim with your hand as the adhesive is exposed to the door. Then pull the bottom tape liner down about 80 mm. Follow the tape with your hand, pressing the trim adhesive against the door.

Continue pulling the tape liner loose, alternating between the top and bottom and pressing the Side Trim against the door.

7 Remove the Protective Film From the Outside of the Side Trim.

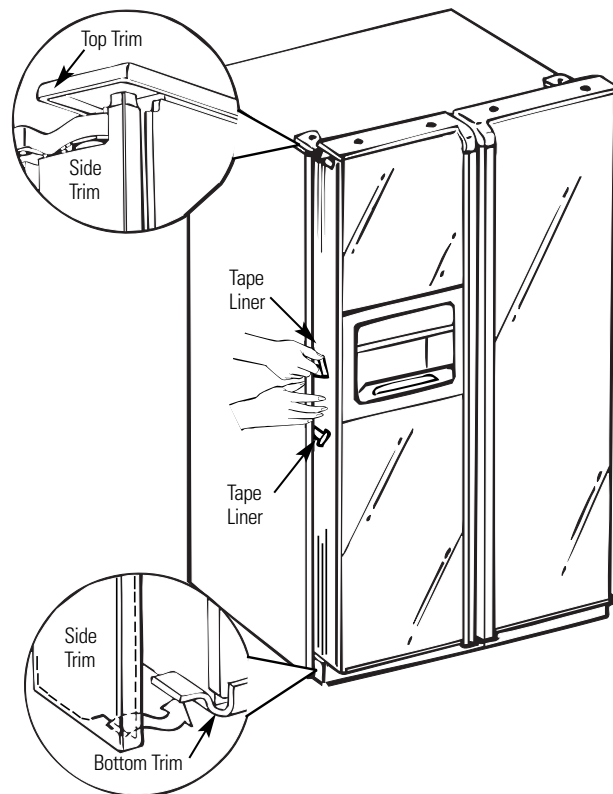

Installing and removing previously installed decorator panels.

Read these instructions completely and carefully.

Removing the Handles

In order to remove the decorator panels and replace with new panels you need to remove the handles. A T-20 Torx driver is needed.

- 1 Loosen and remove the 2 screws in the Top Trim.
- 2 Loosen and remove the 2 screws in the bracket that attaches the Handle to the top of the Door.
- 3 Grip the Handle firmly and slide upwards. The keyhole slots on the Handle slide off the buttons on the door.
- 4 Open the door and slide out the decorator panels.

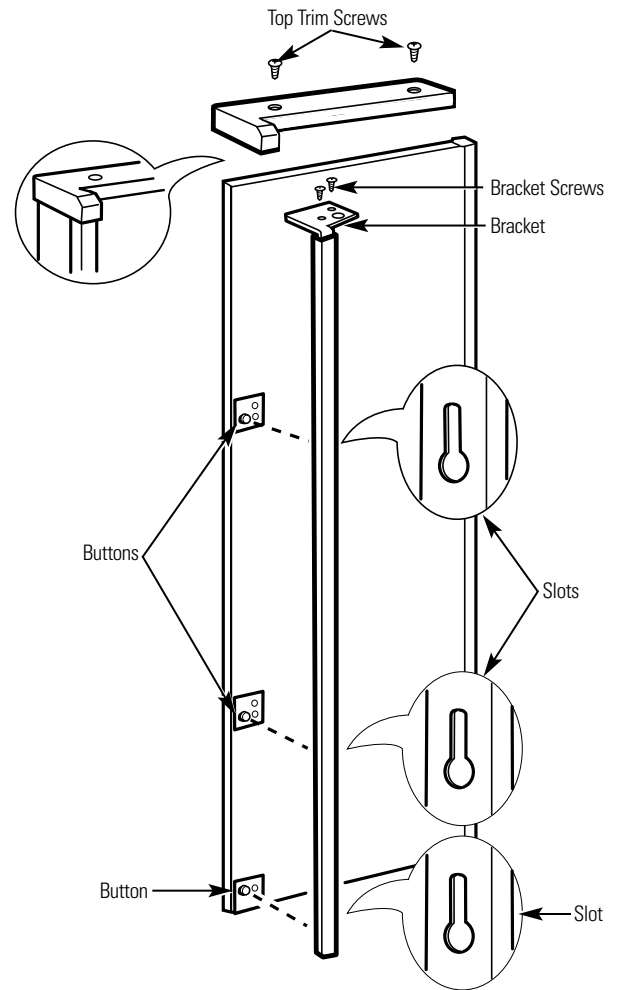

Inserting the Door Panels

Before installing the decorator panels, make sure they have been routed out in the proper areas as shown in the beginning of this section. Slide in the panels to perform a trial fit before fastening down the Handle and Top Trim.

Installing the Handles

Once the panels are fitted properly, install the Handle and Top Trim.

- 1 Slide the keyhole slots on the Handle down onto the buttons mounted to the face of the door. Slide the Handle downward until the bracket at the top of the Handle fits flush on the top of the door.
- 2 Replace the two screws in the bracket that attach the Handle to the top of the Door and tighten the screws to 5.1 N-m torque.
- 3 Replace the Top Trim making sure it fits over the Side Trim and that the locating tabs fit the inside of the Handle profile.
- 4 Replace the Top Trim screws and tighten to 3.4 N-m torque.

Removing and replacing the doors.

When installing or moving the refrigerator, the doors may need to be removed in order to fit the refrigerator through a doorway.

Removing the Doors

Make sure the doors are closed and the refrigerator is unplugged.

1 Disconnect water line and wiring harness.

Near the lower hinge on the freezer side, push in on the collars at each end of the coupling, and pull the water line tubing from the coupling. Also, disconnect wiring harness. Pull the water line and the harness through the lower rail.

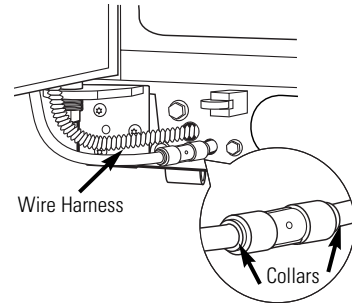

2 Remove the hinge covers and the hinges.

In order to access the hinges, the hinge covers need to be removed. Remove the cover by grasping it on the sides, near the back of the cover. Push back on the cover and lift up at the back, then the front.

NOTE: DO NOT use a screwdriver to remove the cover. BE CAREFUL not to break the rear retaining tab on the hinge cover. Remove the hinges using a Torx T-20.

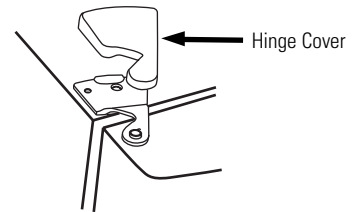

3 Remove the doors.

Carefully rotate the door to 90°. Guiding the disconnected water line and wiring harness, lift the door straight up.

NOTE: Not lifting the door straight up may damage the bottom hinge. Place doors on a protected surface.

NOTE: Be careful not to pinch the water tubing and the wire harness at the bottom of the door.

NOTE: Do not allow the connector to contact the floor. Hard contact can damage the connector. See "Replacing the Doors."

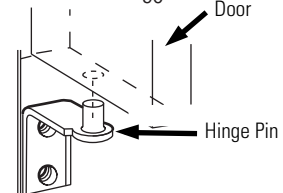
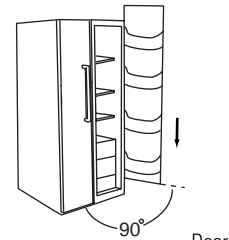

Replacing the Doors

1 Place doors on bottom hinges.

With the door at 90°, lower the door straight down onto the bottom hinge. Carefully close the door.

NOTE: Not lowering the door straight down onto the bottom hinge may damage the hinge.

NOTE: Do not allow the connector to contact the floor. Hard contact can damage the connector.

2 Replace top hinges and hinge covers.

Reinstall the top hinges using a Torx T-20. Replace the hinge covers. If the doors are not level, adjust the bottom right hinge with a 7/16" open ended wrench.

3 Reconnect water line and wiring harness.

Insert water tubing back into coupling, making sure the tubing is pushed far enough into the coupling so that you no longer see the mark on the tubing. Reconnect the wiring harness.

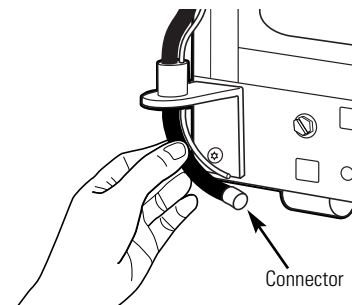

4 Turn on the water supply and plug the refrigerator back in.

Installation Instructions

Refrigerator

Models 21, 23, 25, 27 & 29

BEFORE YOU BEGIN

Read these instructions completely and carefully.

- **IMPORTANT** – Save these instructions for local inspector's use.
- **IMPORTANT** – Observe all governing codes and ordinances.
- **Note to Installer** – Be sure to leave these instructions with the Consumer.
- **Note to Consumer** – Keep these instructions for future reference.
- **Skill level** – Installation of this appliance requires basic mechanical skills.
- **Completion time** – Refrigerator Installation 15 minutes
- Proper installation is the responsibility of the installer.
- Product failure due to improper installation is not covered under the Warranty.

WATER SUPPLY TO THE ICEMAKER (ON SOME MODELS)

If the refrigerator has an icemaker, it will have to be connected to a cold water line. An approved water supply kit is available at extra cost from your local distributor.

Maximum permissible inlet water pressure—8.3 bars.
Minimum permissible inlet water pressure—1.4 bars.

Installation of the icemaker must be done by a qualified service technician.

REFRIGERATOR LOCATION

- Do not install the refrigerator where the temperature will go below 16°C because it will not run often enough to maintain proper temperatures.
- Do not install the refrigerator where the temperature will go above 37°C because it will not perform properly.
- Install it on a floor strong enough to support it fully loaded.

CLEARANCES

Allow the following clearances for ease of installation, proper air circulation and plumbing and electrical connections:

	21' and 23'	25', 27', and 29'
• Sides	4 mm	4 mm
• Top	25 mm	25 mm
• Back	13 mm	25 mm

DIMENSIONS

	29	27	25	23	21
A*	1733 mm	1733 mm	1733 mm	1733 mm	1733 mm
B	908 mm	908 mm	908 mm	908 mm	908 mm
C**	912 mm	879 mm	879 mm	738 mm	738 mm
D	1261 mm	1271 mm	1271 mm	1156 mm	1156 mm
E	1273 mm	1255 mm	1247 mm	1232 mm	1214 mm
F	1051 mm	1093 mm	1099 mm	989 mm	986 mm
G	1386 mm	1381 mm	1381 mm	1361 mm	1355 mm
H	1140 mm	1150 mm	1149 mm	1023 mm	994 mm

*Height does not include hinge.

**Depth includes handle.

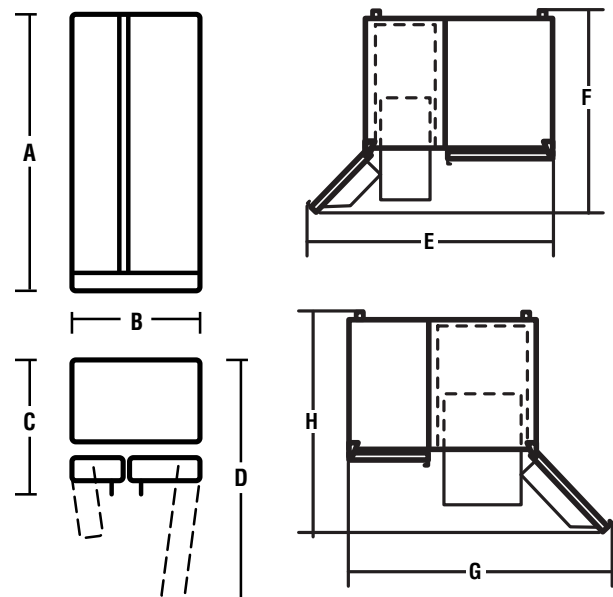

Installation Instructions

ROLLERS

The rollers have 3 purposes:

- Rollers adjust so the door closes easily when opened about halfway. [Raise the front about 5/8" (16 mm) from the floor.]
- Rollers adjust so the refrigerator is firmly positioned on the floor and does not wobble.
- Rollers allow you to move the refrigerator away from the wall for cleaning.

Final leveling adjustments should be made after the refrigerator has been installed.

To adjust the rollers on 25', 27', and 29' models:

- Turn the roller adjusting screws **clockwise to raise** the refrigerator, **counterclockwise to lower** it. Use a 3/8" hex socket or wrench, or an adjustable wrench.

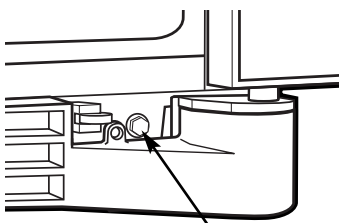

Roller adjusting screw

To adjust the rollers on 21' and 23' models:

- 1 Remove the base grille by opening the doors, removing the screws at each end, and pulling it straight out.
- 2 Turn the front roller adjusting screws **clockwise to raise** the refrigerator, **counterclockwise to lower** it. Use a 3/8" hex socket or wrench, or an adjustable wrench.
- 3 These models also have rear adjustable rollers so you can align the refrigerator with your kitchen cabinets. Use a long-handled 5/16" socket wrench to turn the screws for the rear rollers—**clockwise to raise** the refrigerator, **counterclockwise to lower** it.
- 4 Replace the base grille.

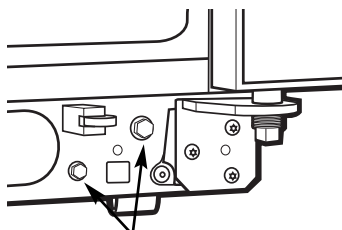

Roller adjusting screws

DOOR ALIGNMENT

After leveling, make sure that doors are even at the top.

To make the doors even, adjust the refrigerator door.

- 1 Using a 7/16" socket wrench, turn the door adjusting screw to the right to raise the door, to the left to lower it. (A nylon plug, imbedded in the threads of the pin, prevents the pin from turning unless a wrench is used.)
- 2 After one or two turns of the wrench, open and close the refrigerator door and check the alignment at the top of the doors.

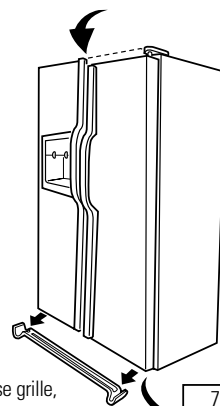

To remove the base grille, open the doors, remove the screw at each end of the base grille and then pull the grille straight out.

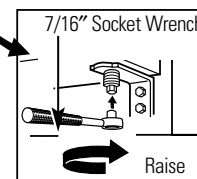

Installation Instructions

DIMENSIONS AND SPECIFICATIONS (for Built-In Style models)

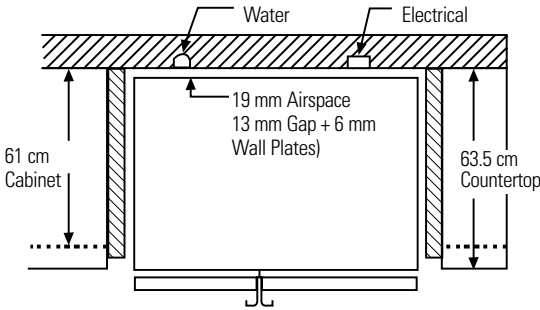
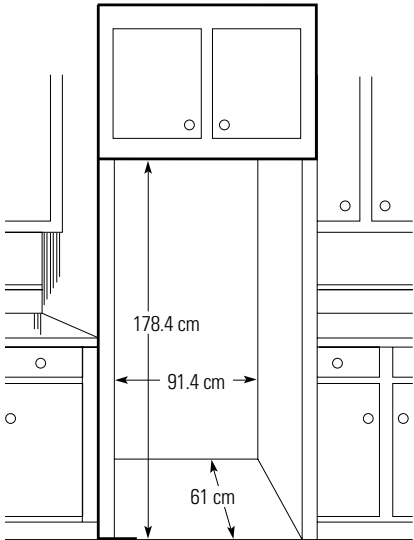

Installation Instructions

INSTALLING THE WATER LINE

BEFORE YOU BEGIN

The water line installation is not warranted by the refrigerator or icemaker manufacturer. Follow these recommendations carefully to minimize the risk of expensive water damage.

Water hammer (water banging in the pipes) in house plumbing can cause damage to refrigerator parts and lead to water leakage or flooding. Call a qualified plumber to correct water hammer before installing the water supply line to the refrigerator.

To prevent burns and product damage, do not hook up the water line to the hot water line.

If you use your refrigerator before connecting the water line, make sure the icemaker power switch is in the **O (off)** position.

Do not install the icemaker tubing in areas where temperatures fall below freezing.

When using any electrical device (such as a power drill) during installation, be sure the device is insulated or wired in a manner to prevent the hazard of electric shock.

All installations must be in accordance with local plumbing code requirements.

Installation of the icemaker must be done by a qualified service technician.

⚠ WARNING! Connect to potable water supply only.

1 CONNECT THE TUBING TO THE REFRIGERATOR

NOTES:

- Before making the connection to the refrigerator, be sure the refrigerator power cord is not plugged into the wall outlet.
- We recommend installing a water filter if your water supply has sand or particles that could clog the screen of the refrigerator's water valve. Install it in the water line near the refrigerator.

1 CONNECT THE TUBING TO THE REFRIGERATOR (CONT.)

Some models have the refrigerator connection at the end of tubing located outside the compressor compartment access cover. On other models the compressor compartment access cover must be removed in order to access the refrigerator connection at the water valve.

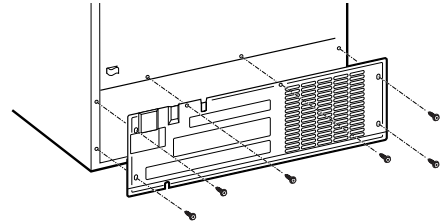

On models using the refrigeration connection at the water valve, remove the plastic flexible cap.

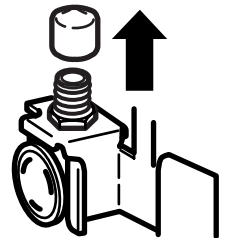

Place the compression nut and ferrule (sleeve) onto the end of the tubing as shown.

Insert the end of the tubing into the water valve connection as far as possible. While holding the tubing, tighten the fitting.

Fasten the tubing into the clamp provided to hold it in a vertical position. You may need to pry open the clamp.

One of the illustrations below will look like the connection on your icemaker.

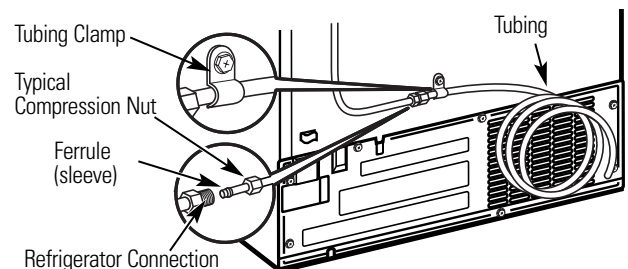
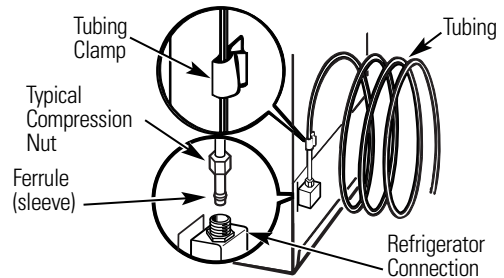

Reattach the access cover.

Installation Instructions

INSTALLING THE WATER LINE (CONT.)

2 TURN THE WATER ON AND PLUG IN THE REFRIGERATOR

Arrange the coil of tubing so that it does not vibrate against the back of the refrigerator or against the wall. Push the refrigerator back to the wall.

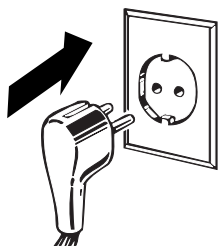

3 START THE ICEMAKER

Set the icemaker power switch to the **I** position. The icemaker will not begin to operate until it reaches its operating temperature of -9°C or below. It will then begin operation automatically if the icemaker power switch is in the **I** position.

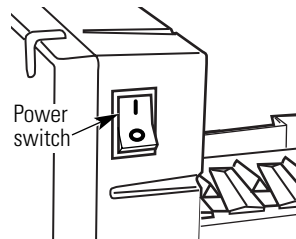

NOTE: In lower water pressure conditions, the water valve may turn on up to 3 times to deliver enough water to the icemaker.

Normal operating sounds.



These sounds are normal and are due mostly to highly efficient operation.

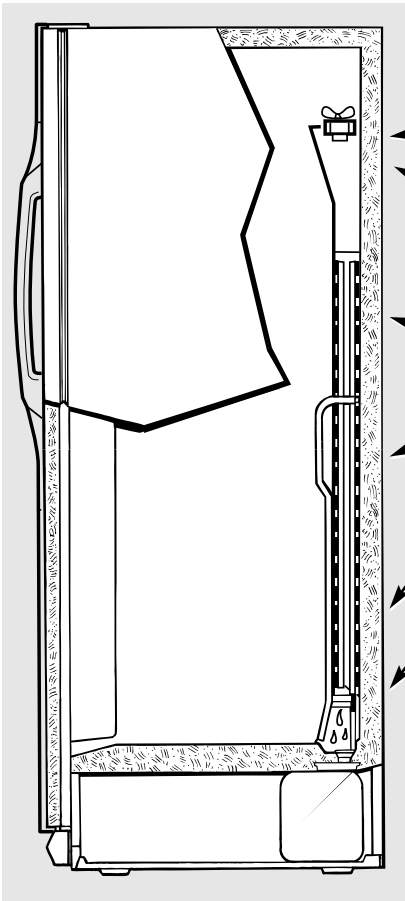

The new high efficiency compressor runs faster and will have a higher pitch hum or pulsating sound while operating.

The fans circulating air inside the freezer and refrigerator compartments which keep the temperatures uniform throughout.

The fans operating at a high speed. This happens when the refrigerator is first plugged in, when the doors are opened frequently, or when a large amount of food is added to the refrigerator or freezer compartments.

Water dropping on the defrost heater causing a sizzling, hissing or popping sound during the defrost cycle.

The flow of refrigerant through the freezer cooling coils sounds like boiling water or a gurgling noise.

Cracking or popping of cooling coils caused by expansion and contraction during defrost and refrigeration following defrost.

Water dripping as it melts from the evaporator and flows to the drain pan during the defrost cycle.

Icemaker

The icemaker water valve will buzz when the icemaker fills with water. If the power switch is in the **I (on)** position it will buzz even if it has not yet been hooked up to water. Keeping the power switch in the **I (on)** position before it is hooked up to water can damage the icemaker. To prevent this, set the power switch to the **O (off)** position. This will stop the buzzing.

The sound of cubes dropping into the bin and water running in pipes as icemaker refills.

Before you call for service...



Troubleshooting Tips
Save time and money! Review the charts on the following pages first and you may not need to call for service.

Problem	Possible Causes	What To Do
Refrigerator does not operate	Refrigerator in defrost cycle.	• Wait about 30 minutes for defrost cycle to end.
	Either or both controls set to 0 (off).	• Set the controls to a temperature setting.
	Refrigerator is unplugged.	• Push the plug completely into the outlet.
	The fuse is blown/ circuit breaker is tripped.	• Replace fuse or reset the breaker.
	The refrigerator is in showroom mode.	• Unplug the refrigerator and plug it back in.
Vibration or rattling (slight vibration is normal)	Rollers need adjusting.	• See <i>Rollers</i> .
Motor operates for long periods or cycles on and off frequently. (Modern refrigerators with more storage space and a larger freezer require more operating time. They start and stop often to maintain even temperatures.)	Normal when refrigerator is first plugged in.	• Wait 24 hours for the refrigerator to completely cool down.
	Often occurs when large amounts of food are placed in refrigerator.	• This is normal.
	Door left open.	• Check to see if package is holding door open.
	Hot weather or frequent door openings.	• This is normal.
	Temperature controls set at the coldest setting.	• See <i>About the controls</i> .
Refrigerator or freezer compartment too warm	Temperature control not set cold enough.	• See <i>About the controls</i> .
	Warm weather or frequent door openings.	• Set the temperature control one step colder. See <i>About the controls</i> .
	Door left open.	• Check to see if package is holding door open.
Frost or ice crystals on frozen food (frost within package is normal)	Door left open.	• Check to see if package is holding door open.
	Too frequent or too long door openings.	
Divider between refrigerator and freezer compartments feels warm	Automatic energy saver system circulates warm liquid around front edge of freezer compartment.	• This helps prevent condensation on the outside.
Automatic icemaker does not work	Icemaker power switch is in the off position.	• Set the power switch to the on position.
	Water supply turned off or not connected.	• See <i>Installing the water line</i> .
	Freezer compartment too warm.	• Wait 24 hours for the refrigerator to completely cool down.
	Piled up cubes in the storage bin cause the icemaker to shut off.	• Level cubes by hand.
	Ice cubes stuck in icemaker. (Green power light on icemaker blinking).	• Turn off the icemaker, remove cubes, and turn the icemaker back on.

Problem	Possible Causes	What To Do
Ice cubes have odor/taste	Ice storage bin needs cleaning.	• Empty and wash bin. Discard old cubes.
	Food transmitting odor/taste to ice cubes.	• Wrap foods well.
	Interior of refrigerator needs cleaning.	• See <i>Care and cleaning</i> .
Small or hollow cubes	Water filter clogged.	• Replace filter cartridge with new cartridge or with plug.
Slow ice cube freezing	Door left open.	• Check to see if package is holding door open.
	Temperature control not set cold enough.	• See <i>About the controls</i> .
Cube dispenser does not work	Icemaker turned off or water supply turned off.	• Turn on icemaker or water supply.
	Ice cubes are frozen to icemaker feeler arm.	• Remove cubes.
	Irregular ice clumps in storage container.	• Break up with fingertip pressure and discard remaining clumps. • Freezer may be too warm. Adjust the freezer control to a colder setting, one position at a time, until clumps do not form.
	Dispenser is LOCKED.	• Press and hold the LOCK CONTROL pad for 3 seconds.
Water has poor taste/odor	Water dispenser has not been used for a long time.	• Dispense water until all water in system is replenished.
Water in first glass is warm	Normal when refrigerator is first installed.	• Wait 24 hours for the refrigerator to completely cool down.
	Water dispenser has not been used for a long time.	• Dispense water until all water in system is replenished.
	Water system has been drained.	• Allow several hours for replenished supply to chill.
Water dispenser does not work	Water supply line turned off or not connected.	• See <i>Installing the water line</i> .
	Water filter clogged.	• Replace filter cartridge or remove filter and install plug.
	Air may be trapped in the water system.	• Press the dispenser arm for at least two minutes.
	Dispenser is LOCKED.	• Press and hold the LOCK CONTROL pad for 3 seconds.
Water spurting from dispenser	Newly-installed filter cartridge.	• Run water from the dispenser for 3 minutes (about six liters).
Water is not dispensed but icemaker is working	Water in reservoir is frozen.	• Call for service.
	Refrigerator control setting is too cold.	• Set to a warmer setting.
No water or ice cube production	Supply line or shutoff valve is clogged.	• Call a plumber.
	Water filter clogged.	• Replace filter cartridge or remove filter and install plug.
	Dispenser is LOCKED.	• Press and hold the LOCK CONTROL pad for 3 seconds.
CUBED ICE was selected but CRUSHED ICE was dispensed	Last setting was CRUSHED ICE.	• A few cubes were left in the crusher from the previous setting. This is normal.

Before you call for service...

Problem	Possible Causes	What To Do
Orange glow in the freezer	Defrost heater is on.	<ul style="list-style-type: none"> This is normal.
Refrigerator has odor	Foods transmitting odor to refrigerator.	<ul style="list-style-type: none"> Foods with strong odors should be tightly wrapped. Keep an open box of baking soda in the refrigerator; replace every three months.
	Interior needs cleaning.	<ul style="list-style-type: none"> See <i>Care and cleaning</i>.
Door not closing properly	Door gasket on hinge side sticking or folding over.	<ul style="list-style-type: none"> Apply paraffin wax to the face of the gasket.
	A door bin is hitting a shelf inside the refrigerator.	<ul style="list-style-type: none"> Move the door bin up one position.
Moisture forms on outside of refrigerator	Not unusual during periods of high humidity.	<ul style="list-style-type: none"> Wipe surface dry.
Moisture collects inside (in humid weather, air carries moisture into refrigerator when doors are opened)	Too frequent or too long door openings.	
Interior light does not work	No power at outlet.	<ul style="list-style-type: none"> Replace fuse or reset the breaker.
	Lightbulb burned out.	<ul style="list-style-type: none"> See <i>Replacing the lightbulbs</i>.
Water on kitchen floor or on bottom of freezer	Cubes jammed in chute.	<ul style="list-style-type: none"> Poke ice through with a wooden spoon.
Hot air from bottom of refrigerator	Normal air flow cooling motor. In the refrigeration process, it is normal that heat be expelled in the area under the refrigerator. Some floor coverings are sensitive and will discolor at these normal and safe temperatures.	
Refrigerator never shuts off but the temperatures are OK	Adaptive defrost keeps compressor running during door openings.	<ul style="list-style-type: none"> This is normal. The refrigerator will cycle off after the door remains closed for 2 hours.
Refrigerator beeping	Door open.	<ul style="list-style-type: none"> Close door.
Food isn't thawing/chilling	Packaging.	<ul style="list-style-type: none"> Increase time or re-package in plastic.
	Wrong weight selected.	<ul style="list-style-type: none"> Select a larger weight.
	Item with high fat content.	<ul style="list-style-type: none"> Select a larger weight.
	Not using Chill/Thaw tray.	<ul style="list-style-type: none"> Place items on tray and allow space in between items for better air flow.
Actual temperature not equal to Set temperature	Unit just plugged in.	<ul style="list-style-type: none"> Allow 24 hours for system to stabilize.
	Door open for too long.	<ul style="list-style-type: none"> Allow 24 hours for system to stabilize.
	Warm food added to refrigerator.	<ul style="list-style-type: none"> Allow 24 hours for system to stabilize.
	Defrost cycle is in process.	<ul style="list-style-type: none"> Allow 24 hours for system to stabilize.
Select Temp feature is not working	Refrigerator compartment temperature control is set at warmest setting.	<ul style="list-style-type: none"> This is normal. In order to minimize energy usage, the Select Temp feature is disabled when the refrigerator temperature control is set at the warmest setting.

Special Safety Instructions for Australia and New Zealand.

(in addition to other information in Owner's Manual)



IMPORTANT SAFETY INSTRUCTIONS

To reduce the risk of personal injury or damage to property, follow basic safety precautions when using this refrigerator, including the following:

When using any Electrical Product, basic precautions should always be followed, including the following:

READ THESE INSTRUCTIONS CAREFULLY BEFORE USING THE REFRIGERATOR. KEEP THE INSTRUCTIONS HANDY FOR FUTURE REFERENCE.

- **IMPORTANT:** Always operate the refrigerator from a power source of the same Voltage, Frequency and Rating as indicated on the refrigerator identification plate. Operate the refrigerator from an Earthed (Grounded) 3 pin power outlet fully accessible when the refrigerator is located in its normal operating position.
- Close supervision is necessary when any electrical product is used by or operated near children or infirm persons; young children should be supervised to ensure that they do **not** play with the refrigerator.
- **IMPORTANT:** Do not operate the refrigerator with a damaged Supply cord or Plug. If it is damaged it must be replaced by the manufacturer, distributor or its service agent or a similarly qualified person in order to avoid a hazard. Special tools are required to replace the Supply flexible cord.

- **WARNING:** Avoid the use of extension cords. If it is necessary to use an extension cord, prior to its use, make sure the extension cord is safe to use, capable of handling the electrical load of the product (refer Product identification plate) and has been checked and tested by your electricity supplier or a qualified technician.

To avoid becoming entangled in the cord, **never** lay it through or along a walkway or thoroughfare

- Do **not** allow the cord to hang over the edge of a bench top where it may be grabbed by children or become entangled with the user.

Special Installation Instructions for Australia and New Zealand.

Installing the Water Line

For Australian and New Zealand installation, read these instructions completely and carefully.

Before You Begin

- **IMPORTANT:** Government legislation and Codes in most States and Territories of Australia require installation by a licensed plumber. The installation must conform to Australian Standard AS 3500.1 Water supply.
- Water hammer (water banging in the pipes) in house plumbing can cause damage to the refrigerator parts and lead to water leakage or flooding. Call a qualified plumber to correct water hammer before installing the water supply line to the refrigerator.
- To prevent burns and refrigerator damage, do not hook up the water line to the hot water line.
- If you use your refrigerator before connecting the water line, make sure the icemaker power switch is set to the **0** position.
- Do not install the icemaker tubing in areas where the temperatures fall below freezing.

Shut Off the Main Water Supply

For models fitted with an icemaker, a **water supply kit** (containing flexible tubing and fittings) is supplied with the refrigerator.

The water pressure must be between 138 and 827 kPa on models without a water filter fitted and between 275 and 827 kPa on models with a water filter fitted.

Turn **Off** the water and open a low tap to drain the water from the pipe.

Complying with the plumbing codes, install a suitable branch fitting (not supplied) to the cold water supply.

Extend the branch to a suitable location adjacent to the refrigerator when it is located in its operating position. Terminate the branch with a shutoff valve (not supplied).

IMPORTANT: The shut-off valve should be accessible (such as in an adjacent cupboard, as close to the wall as possible) when the refrigerator is in its normal operating position.

If your water supply pressure is higher than 690 kPa during the day (if so, it may reach higher levels at night), install a suitable Pressure limiting valve (not supplied), after the shut-off valve, making sure the “flow arrows” on the body of the device face the same direction as the water flow.

If necessary, assemble a suitable fitting (not supplied) to the up-stream end of the shutoff valve (or pressure limiting valve) for attachment of the fitting supplied with the water supply kit.

NOTE: PTFE tape should be used for a water tight seal when assembling all the above fittings.

Do **not** turn the water supply **On** at this time.

Connecting the Tubing to the Shutoff Valve

Attach the fitting with the male thread supplied with the water supply kit to the shutoff valve (or pressure limiting valve, if fitted), and tighten.

NOTE: PTFE tape should be used for a water tight seal when assembling all the above fittings.

Route the tubing through a hole drilled in the side of the cupboard as close to the wall as possible.

Make sure there is sufficient length of tubing [approximately 240 cm coiled into 3 turns of approximately 25 cm] to allow the refrigerator to move out from the wall after installation.

Insert and push the end of the tubing into the fitting as far as possible.

With the free end of the tubing located in a suitable container, turn the main water supply **On** and flush out the tubing until the water is clear.

Turn **Off** the shutoff valve after approximately 1 litre of water has been flushed through the tubing.

Connecting the Tubing to the Refrigerator

*Before making the connection to the refrigerator, be sure the power is turned **OFF** and the power cord is disconnected from the Power Outlet.*

If your refrigerator does not include a water filter, we recommend installing one in the water line near the refrigerator if your water supply has sand or particles that could clog the screen of the refrigerator's water valve.

Remove the refrigerator access cover.

Remove the plastic flexible cap from the water valve (refrigerator connection).

Attach the fitting with the female thread supplied with the water supply kit to the water valve and tighten.

Insert and push the end of the tubing into the fitting as far as possible.

Fasten the tubing into the clamp provided to hold it in position. You may need to pry open the clamp.

Special Installation Instructions for Australia and New Zealand.

Installing the Water Line (continued)

Turn the Water On

Turn the water **On** at the shutoff valve.

Tighten any connection that leaks.

Replace the access cover and tighten all screws (on some models).

Plug In the Refrigerator

Plug in the refrigerator to the Power Outlet and turn **On**.

IMPORTANT: Always operate the Refrigerator from a power source of the same Voltage, Frequency and Rating as indicated on the Refrigerator Identification Plate. Operate the Refrigerator from an Earthed (Grounded) 3 Pin Power Outlet fully accessible when the refrigerator is located in its normal operating position.

Arrange the coil of tubing so that it does not vibrate against the back of the refrigerator or against the wall.

Push the refrigerator back to the wall making sure the power cord and the water line tubing are not trapped, entangled or squashed by the refrigerator (including the wheels) or wall.

Start the Icemaker

Set the icemaker power switch to the **I** position.

The icemaker will not begin to operate until it reaches its operating temperature of -9°C or below. It will then begin operation automatically if the icemaker power switch is in the **I** position.

NOTE: In lower water pressure conditions, the water valve may turn on up to 3 times to make sure enough water reaches the icemaker.

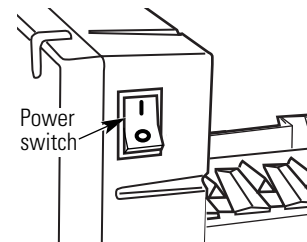

Notes.
