

# Cooking collection

## Instructions for Use and Warranty Details

TO550X - Designer 1.5 Multi Function Electronic Oven - Stainless Steel  
TO550W - Designer 1.5 Multi Function Electronic Oven - White



**C**ongratulations on the purchase of your new appliance. This appliance has been designed and manufactured to give you years of reliable performance.

**For best results, carefully read the instructions on how to install your new appliance. Correct installation will avoid delays and unnecessary service calls.**

**Once installation is complete, read this booklet carefully and get to know the controls and the features of your new appliance.**

**We reserve the right to alter the specifications with no influence on the operation of the appliance. This instruction manual cannot be reason for a claim.**

## SAFETY PRECAUTIONS

- To avoid any possible hazard, the appliance must be installed by qualified personnel only.
  - Any repairs by unqualified persons may result in electric shock or short circuit. In order to avoid possible injuries to your body or to the appliance, always use a qualified authorised service agent.
  - Hot fat is highly flammable, so pay extra attention when preparing food with grease or oil. Frying may be carried out only under constant surveillance.
  - **WARNING!** Never let small children in the vicinity of the oven; they are not yet aware of the danger of burns. Older children may use the appliance only under your surveillance.
  - The inside of the oven, and steam exits are also places of potential danger for children.
  - **DANGER OF BURNS!** Oven and cooking accessories may become very hot during operation. To avoid burns use kitchen cloths and gloves when handling hot parts or utensils.
  - Mains leads of adjacent appliances may be damaged by hotplates, or if stuck between the oven doors, and produce a short circuit, therefore keep them at safe distance from the appliance.
- 
- **Take extra precautions when grilling. Intensive heat from the grill element makes the oven and the accessories extremely hot. Use protective gloves and suitable cooking utensils!**
  - **Perforated meat may produce spurting of hot grease (eg. sausages). Use long grill tongs to prevent skin burns and protect your eyes.**
  - **Supervise the grill at all times. Excessive heat may quickly burn your roast and provoke fire!**
  - **Do not let the children in the vicinity of the grill.**

## WARNING!

The appliance is not intended for use by young children or infirm persons without supervision.

## GENERAL INFORMATION

The oven data plate remains accessible following installation, and is exposed to view simply by opening the door.

It shows all details needed to identify the appliance, and these must be indicated when ordering replacement parts.

MADE IN EUROPE		NUM.	
TYPE:			
MOD.:			kW
	CE		M

Given the type and height of this built-in oven, it can be installed only in a full-height kitchen unit.

Particular care must be given to the instructions on installing the oven in the unit, especially the indications regarding the size and position of the ventilation opening, which is essential for proper cooling of the enclosure and of the oven itself.

To guarantee the safety of the user, the unit housing of the oven must be manufactured from materials able to withstand temperatures up to 120 °C. This includes core materials, laminates, facings and adhesives.

## CONTROL PANEL

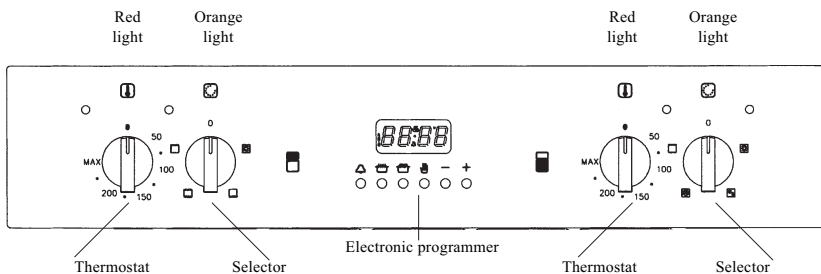

## ***“Small” oven***

The oven offers a basic choice between two types of cooking:

- A) conventional oven cooking
- B) grill (infrared radiant heat)

Selector functions:

Position 0:        The oven is switched OFF

Position 1:        Oven interior light (turn to the right)



Position 2:        Lower heating element



Set the required temperature between 50 and 250 °C. This setting is used typically for food to be reheated or warmed.

Position 3:        Conventional cooking



Set the required cooking temperature between 50 and 250 °C. The red light will go out as soon as the selected temperature has been reached. The oven should be heated before any food is put in to cook.

Position 4:        Grill



Set the thermostat at a temperature between 50 and 250 °C. The red light will go out as soon as the selected temperature has been reached. The oven should be heated for approximately 5 minutes before food is put under the grill. Keep the door closed.

### Oven accessories:

- 1 x wire shelf
- 1 x baking pan

## ***“Large” oven***

Selector functions:

Position 0: The oven is switched OFF

Position 1: *Oven interior light*



Position 2: *Conventional cooking*



Set the required cooking temperature between 50 and 250 °C. The red light will go out as soon as the selected temperature has been reached. The oven should be heated before any food is put in to cook.

Position 3: *Traditional cooking + Fan assisted*



Set the thermostat between 50 and 250 °C.

This cooking mode integrates natural convection and fan. Cooking mode suited to bake bread, pizzas and lasagne.

Position 4: *Fan + Bottom heating element*



Set the desired temperature for this very delicate and slow cooking mode. We suggest you do not pre-heat the oven.

Position 5: *Middle Grill*



Use the thermostat to the desired temperature between 50 and 250 °C, while keeping the oven door closed. This cooking mode is ideal for small amounts of food.

Position 6: *Fan + Double Grill*



Set the thermostat to the desired temperature between 50 and 250 °C.

Fan operation combined with the grill lets you cook particular foods quickly and deeply. We suggest you pre-heat the oven for a few minutes before inserting food.

Position 7: *Fan-forced cooking*



The fan and the relative heating element come into operation, and heat will be distributed uniformly around the entire chamber at the temperature selected with the thermostat, between 50 and 250 °C. The oven should be heated before any food is put in to cook. Different types of food can be cooked simultaneously.

### *Oven accessories:*

2 x wire shelves

1 x grill pan

## COOKING TABLE FOR SMALL OVEN - CONVENTIONAL COOKING

IN HEATING SYSTEM WITH TOP AND BOTTOM ELEMENTS OPERATING. It is recommended to preheat the oven 10 min.

DISHES	LEVEL	TEMPERATURE	COOKING TIME
Yorkshire Pudding	1	200°C	30 - 40 min
Fatless Sponge Cake	1	180°C	25 - 30 min
Small Cakes	2	190°C	15 - 20 min
Fruit Plate Tart	1	200°C	40 - 45 min
Scones	2	220°C	10 - 15 min
Rich Fruit Cake	1	140°C	2 - 3 hours

## COOKING TABLE FOR THE TOP SMALL OVEN - WITH GRILL ELEMENT OPERATING

Grilling is carried out with the door closed. 5 minutes oven preheating is recommended. Setting possibility from 50° - max (250)°C. Food is placed on the backing pan grid.

DISHES	LEVEL	TEMPERATURE	COOKING TIME	
			Side 1	Side 2
Pork steaks, Chops (4 pcs)	3	225°C	12 min	10 min
Grilled Sausages (6 pcs)	3	225°C	6 min	5 min
Toast (6 pcs)	3	225°C	1 min/25 sec.	1 min/10 sec.

## COOKING TABLE FOR THE LARGE OVEN - WITH GRILL ELEMENT OPERATING

Grilling is carried out with the door closed. 5 minutes oven preheating is recommended. Setting possibility from 50° - max (250)°C. Food is placed on the backing pan grid.

DISHES	TEMPERATURE	LEVEL	COOKING TIME	
			Side 1	Side 2
Pork steaks, Chops (4 pcs)	250°C	Topmost 5	15 min	12 min
Roast beef (4pcs)	250°C	Topmost 5	10 min	8 min
Grilled Sausages (6 pcs)	250°C	Topmost 5	9 min	6 min
Toast (6 pcs)	250°C	Topmost 5	1 min/50 sec.	1 min/30 sec.





## USING THE OVENS

Set the selector for the type of cooking required.

Preheat the oven, setting the thermostat to the required temperature. Once the oven has heated to the selected temperature, the orange warning light will go out. This same light will appear again automatically during operation of the oven to indicate that the heating elements are on. Remove the drip tray when using the oven for conventional baking, roasting etc. The tray should be left in place only when using the grill, as its purpose is to catch falling droplets of fat. Food should be placed in oven dishes with raised edges and positioned centrally under the grill. If fan-forced operation is selected, foods of different types can be cooked simultaneously (e.g. meat and fish), although in this case the respective cooking time must be observed.

If selecting the  position, temperatures must be set 10 to 20°C lower than indicated in the table.

## Cooking temperatures and times

Dish	Temperature in degrees centigrade		Approximate cooking time in minutes
			
<b>Sweets</b>	175	160	55-65
Short pastry flan base	200	190	8-10
Fruit pie/tart	200	190	25-35
White leavened bread per 1 kg flour	200	190	30-50
Shortcake biscuits	200	190	10-15
Savoury biscuits	200	190	15-20
Lasagne	225	210	40-50
<b>Meat</b> (cooking time based on thickness)			
Slow roast	175	170	12-15
Quick roast	200	190	12-15
Meat loaf	200	190	30-40
<b>Poultry</b>			
Duck 1.5 -2 kg	200	170	120-180
Goose 3 kg	200	180	150-210
Roast chicken	200	190	60-90
Turkey 5 kg	175	150	240 ca.
<b>Game</b>			
Hare	200	180	60-90
Leg of roebuck	200	180	90-150
Haunch of venison	175	175	90-180
<b>Vegetable</b>			
Vegetable soufflé	200	180	40-45
Fish	180	170	40-45
Pizza	210	200	20-25
<b>Grills</b>			
Pork chop			8-12
Sausage			10-12
Grilled chicken			25-35

## ROASTING GUIDE

- Frozen meat should be thoroughly defrosted before cooking. For large joints it is advisable to defrost overnight.
- Frozen poultry should be thoroughly defrosted before cooking. The time required depends on the size of the bird e.g. a large turkey may take up to 48 hours to defrost.
- Adjust the shelf position so the meat or poultry will be in the centre of the oven.

The TIMES given in the ROASTING GUIDE are only approximate because the size, shape of the joint and the proportion of bone will influence cooking times.

<b>Cook in oven</b>		<b>Approximate cooking time</b>
<b>180°C (Fan oven)</b>		
<b>200°C (Conventional oven)</b>		
BEEF	Rare	20 minutes per 450g. (1lb) plus 20 minutes
	Medium	25 minutes per 450 g (1 lb) plus 20 minutes
	Well Done	30 minutes per 450 g (1 lb) plus 30 minutes
LAMB	Medium	25 minutes per 450 g (1 lb) plus 25 minutes
	Well Done	30 minutes per 450 g (1 lb) plus 30 minutes
PORK		35 minutes per 450 g (1 lb) plus 35 minutes
POULTRY		20 minutes per 450 g (1 lb) plus 20 minutes

### Notes:

If you are cooking a very large turkey e.g. over 6kg (14lb), we recommend that it is turned around halfway through cooking so that both legs will be cooked evenly. Remove any excess fat from the tin before turning, to prevent any fat splashing.

When cooking stuffed meat or poultry, calculate the cooking time from the total weight of the meat plus the stuffing.

For joints cooked in foil or covered roasters, and for lidded casseroles, add 5 minutes per 450g. (1lb) to the calculated cooking time.

Smaller joints weighing less than 1.25 kg (2 lb) may require 5 minutes per 450g (1lb) extra cooking time.

## **INSTRUCTIONS FOR USE**

### **General instructions**

**CAUTION:** The oven door becomes hot during use. Be sure to keep children well away!

Do not use the oven as a room heater.

Always be very careful when connecting other electrical appliances to the power supply. If these are situated near the oven the power cables must not come into contact with hot parts of the oven.

To ensure the oven will always be safe, any servicing — especially of electrical parts — should be entrusted exclusively to a qualified service agent.

Clean the oven every time after use. This will make it easier to remove dirt and grease and ensure that deposits do not build up.

Use earthenware oven dishes enamelled steel or pyrex - type glass for roasting and baking, selecting a suitable size for the bulk and quantity of the food being cooked. Stainless steel ovenware is not recommended, as the metal reflects heat.

If the interior light should fail, disconnect the oven from the electrical power before removing and replacing the lamp.

### **Using first time**

Before using the oven for the first time, clean the interior thoroughly with liquid detergent and lukewarm water. Wipe off, then heat the oven to maximum temperature and leave on for 20 minutes. This will ensure that residual oil and grease used in the manufacturing process do not give off unpleasant smells when food is cooked in the oven.

Once this has been done, the oven is ready for use.

**CAUTION:** Ensure the oven is disconnected from the electrical power supply before carrying out any cleaning operation on the oven.

### **Final checks**

Having installed the oven in its enclosure, and before switching on, be certain to check that there are no live parts accessible, and that all the packing has been removed.

At this point the oven can be switched on as described in the instructions.

## INSTALLATION



### CAUTION:

**THIS APPLIANCE MUST BE INSTALLED BY A PROFESSIONAL ELECTRICIAN, AND IN ACCORDANCE WITH THE MANUFACTURER'S INSTRUCTIONS BEFORE CARRYING OUT ANY ADJUSTMENT OR REPAIR ON THE APPLIANCE, MAKE CERTAIN IT IS DISCONNECTED FROM THE ELECTRICAL POWER SUPPLY**

### Statutory regulations, technical standards, directives

The appliance must be installed in conformity with current statutory regulations and in accordance with applicable safety standards.

### Installing the oven

The unit in which the oven is installed must be manufactured to a modular dimension of 600mm.

Openings at least 50 mm deep must be cut both in the bottom and in the top of the unit to ensure adequate ventilation (see figure 1 for essential dimensions).

During assembly, particular care must be taken not to pick up the oven by the door. As a general rule, the oven door should never be forced or subjected to undue stresses.

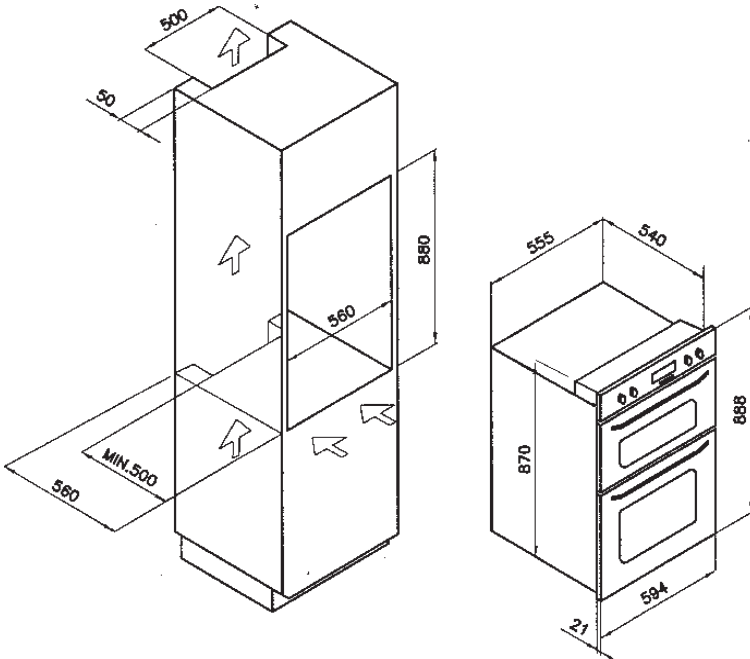

## **Electrical connection**

Make certain the nominal a.c. power supply voltage corresponds to that indicated on the identification data plate. The appliance must be connected to the supply by way of an isolating switch with minimum contact separation of 3 mm. Suitable isolating components include automatic breakers, fuses and relays.

The oven must be connected to an efficient earth system, as prescribed by national and/or local statutory regulations.

The appliance is supplied with a power cable. In the event of the cable being replaced for any reason, the replacement must be as prescribed by statutory regulations and respond to the specifications indicated on the Technical Data page.

The terminal box is located at the rear of the appliance. If a new cable is fitted, route it through the clamp and make the connections as shown in the diagram. The earth wire must be cut longer than the other wires so that it will be the last to break off in the event of the cable being tugged.

Having made the connection, tighten the cable clamp and close the cover of the box.

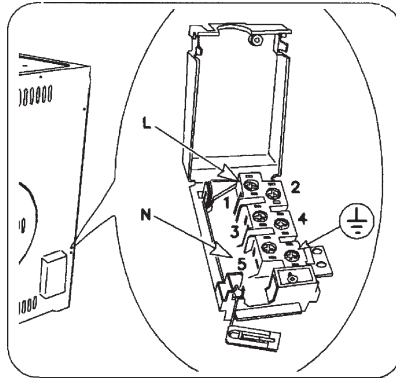

### CONNECTION DIAGRAM

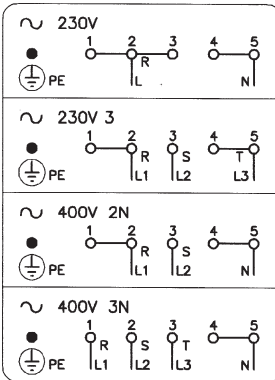

### ELECTRONIC PROGRAMMER





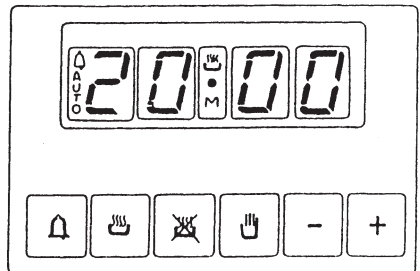

The electronic programmer incorporates the following functions:

- 24 hour clock with luminous display
- 10 hour timer
- automatic operation
- semiautomatic operation

The electronic programmer operates only on the “large” oven.





## Programming buttons and their functions.

	beep 
	cooking time in automatic operation
	cooking stop time
	manual operation
	increase – all programs
	decrease – all programs

## Luminous symbols





When “**AUTO**” blinks, this means that the timer is in “automatic” mode but no setting has yet been made.

When “**AUTO**” remains permanently alight, this means that the timer is in “automatic” mode and already programmed

	automatic operation
	timer in operation
	plus “ <b>AUTO</b> ” blinking: programming error

If there is no symbol alight other than the digits of the clock, this means that the timer is in “manual” mode.

## Digital clock



The timer incorporates a digital electronic clock with luminous numbers indicating the hours and minutes. When the appliance is first connected to the a.c. supply, or following a power cut, three zeroes will blink in the timer window. To set the clock, press and hold the two buttons  and  together, and use the  or  symbol to select the exact time. The longer the increase or decrease button is held, the faster the numbers will scroll. If convenient, the clock can be turned back to **00.00**: to scroll back further at this point, release all the buttons and repeat the sequence, pressing and holding the decrease button until the time appears in the display.

## Normal cooking without using the timer

To operate the oven in manual mode — in other words without using the timer — the blinking “**AUTO**” indicator must be deactivated by pressing the  button.



## Automatic operation (programmed start and stop times)

To cook food in the oven using the automatic timer, proceed as follows:

- establish how long the food needs to cook 
- enter the cooking stop time 
- select the temperature and the cooking method.

Once these steps have been completed, the “**AUTO**” indicator will light up permanently in the display, confirming that the oven has been programmed.



Practical example: we want to cook food for a period of 30 minutes, ending at 14.00.



- Pressing and holding , enter 0.30 in the display.
- Pressing and holding , enter 14.00 in the display.

This done, the display will revert to the current time and “**AUTO**” reappears, confirming that the settings have been acknowledged and memorised. At 13.30 (14.00 minus 30 minutes) the oven switches on automatically and the symbols and “**AUTO**” will appear for as long as cooking continues. The oven will then switch off automatically at 14.00, triggering a beep that can be silenced by pressing .



## Semiautomatic operation

- A. Programming the duration
- B. Programming the stop time.

A) Select the duration for which the food is to cook by pressing . The oven will switch on immediately, with the symbols “**AUTO**” and  showing in the display. Once the set duration has elapsed, cooking will stop and the beep sounds intermittently. Silence the beep as indicated above.

B) Set the time for cooking to stop, by pressing . The oven will switch on immediately, with the symbols “**AUTO**” and  showing in the display. When the set time comes around, cooking will stop and the beep sounds intermittently. Silence the beep as indicated above.

Current programming status can be displayed at any given moment by pressing the corresponding button.

It is also possible to cancel the current selection at any moment by pressing  and resetting the display to zero. Pressing  at this point, the programmer will revert to manual mode.

**CAUTION:** If the oven is disconnected from the power supply, or in the event of a power failure, the clock resets to zero and all programming will be lost. When power is restored, three zeroes appear.



## **CLEANING AND MAINTENANCE**

Never clean the oven with a high pressure steam cleaning device, as it may provoke a short circuit.

Before cleaning, switch the oven off and let it cool down completely.

### **Front side of the casing**

For cleaning of the front part of the oven use the recommended cleaning agents and follow the manufacturer's instructions.

Never use any aggressive cleaning agents or dish cleaning accessories that could cause scratches. For the front door glass use a soft cloth and liquid cleaners for cleaning glass surfaces.

### **Stainless steel front**

Clean the surface with mild detergent (soap) and soft sponge which will not scratch. Never use aggressive cleaners or solvents, otherwise you may damage the surface.

### **Enamel coated and plastic surfaces**

Clean the knobs and handles with a soft cloth and liquid cleaners, intended for use of smooth enamel surfaces.

### **Oven**

The oven may be cleaned in a traditional mode (using oven cleaners and sprays).

Otherwise respect the following cleaning tips:

- Cool the oven completely before cleaning.
- The oven and the accessories must be cleaned after each use, otherwise stains can get burned in.
- Oven walls, sprayed with oil from roasting, are best cleaned with warm water and detergent when the oven is still tepid.
- Hard and heavily stained oven should be cleaned with special oven cleaning agents. Rinse the cleaner thoroughly and remove any detergent remaining before the next use.
- Never use aggressive cleaners, like polishing agents, dish cleaning accessories, corrosion inhibitors, or any other products that can cause scratches.
- Coated, stainless steel or zinc-coated surfaces or aluminium parts must not come into contact with oven sprays, since they might cause damage or discolouration. The same goes for the thermostat probe (if the oven is equipped with it) and exposed elements on the oven ceiling.
- When purchasing cleaning agents remember the environment, and strictly follow the manufacturer's instructions.

## CLEANING AND MAINTENANCE OF THE OVEN

**IMPORTANT:** Before carrying out any maintenance operations on the oven, set the automatic isolating switch to the off position.

The oven's side runners can easily be removed by disconnecting them from the peg in the bottom, turning them towards the inside of the oven and extracting them from the supporting holes.

To put them back in place, reverse this procedure.

Clean the side grids only with conventional detergents.

Removing wire grids.

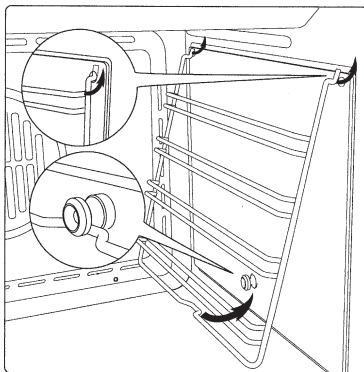

## TECHNICAL DATA

This appliance is manufactured in compliance with RF suppression standards.

- MODEL - RATED VOLTAGE	Multifunction oven 230 V 50Hz
<b>“Large” oven</b>	
	Nominal electrical input in W (toll. +5 /-10%)
- interior light	25 W
- radial fan unit	30 W
- tangential fan unit, large oven	10 W
- circular heating element	2300 W
- middle grill	1200 W
- double grill	2200 W
- upper heating element	1000 W
- lower heating element	1100 W
- Maximum electrical input	2365 W
<b>“Small” oven</b>	
	Nominal electrical input in W (toll. +5 /-10%)
- interior light	25 W
- tangential fan unit	20 W
- upper heating element	750 W
- grill element	1750 W
- lower heating element	850 W
- maximum electrical input	1795 W
- Maximum overall electrical input	4160 W
<b>- Power cable fitted</b>	HO5 RN- F 3 x 2.5 mm <sup>2</sup> section
<b>Dimensions</b>	
- height	mm 888
- width	mm 594
- depth	mm 550
- useable volume	58 + 32 litres

## INTERIOR LIGHT: REPLACING THE LAMP

**CAUTION:** Disconnect the appliance from the power supply.

To replace the lamp of the oven interior light, first unscrew and remove the protective cover A. Renew the lamp, and refit the cover A.

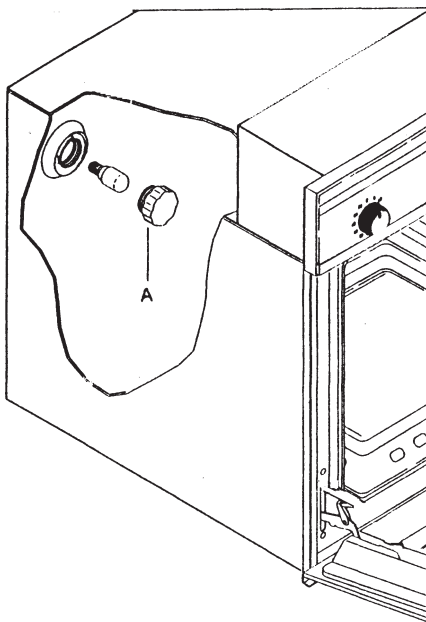

## REMOVING THE OVEN DOOR

The door is easily removed, as follows:

- open the door completely;
- raise the two hinge levers as indicated in the drawing;
- close the door again until a click is produced by the levers raised previously;
- lift the door upward and away from the front of the oven to free it from the sockets;

To refit the door, locate the hinges in the sockets and return the two levers to the locking position.

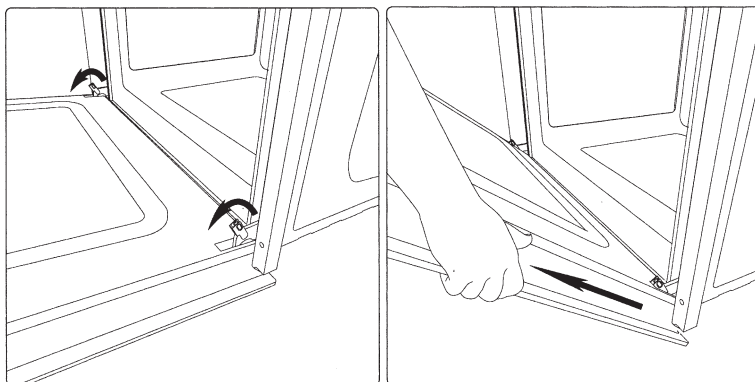

# WARRANTY AND SERVICE

## DOMESTIC WARRANTY - FULL FIVE YEAR WARRANTY

In addition to all statutory rights which you, the Consumer, have under the relevant laws in respect of this appliance, during the first five years of ownership as the original purchaser of this Kleenmaid appliance, we guarantee that any fault caused by faulty material or workmanship becoming apparent will be rectified free of charge for parts and labour, provided that all service is performed during normal working hours by Kleenmaid or their designated Agents. Where the appliance is installed outside the normal servicing area of the above, the Purchaser must pay for the cost of transporting the appliance to and from the Agent or the Agent's travelling cost to and from the Purchaser's home.

## COMMERCIAL WARRANTY - ONE YEAR WARRANTY

When this appliance is installed in a commercial application, you, the Consumer, have under the relevant laws in respect of this appliance, during your first one year of ownership as the original purchaser of this Kleenmaid appliance, we guarantee that any fault caused by faulty material or workmanship becoming apparent, will be rectified free of charge for parts and labour, provided that all service is performed during normal working hours by Kleenmaid or their designated Agents. Where the appliance is installed outside the normal servicing area of the above, the Purchaser must pay for the cost of transporting the appliance to and from the Agent or the Agent's travelling cost to and from the Purchaser's home.

## WHAT THESE WARRANTIES DO NOT COVER

We are not responsible for any damage or malfunction unless caused by a defect in material or workmanship. This includes but is not limited to abuse, misuse, improper installation and transportation damage. We are not responsible for any consequential damages from any malfunction.

The Consumer must make the appliance available for servicing and shall bear any costs incurred for any de-installation and/or re-installation required to make the appliance available for servicing. Kleenmaid is not liable for any consequential damage incurred during de-installation or re-installation.

## WARRANTY DOES NOT COVER REPLACEMENT OF LIGHT GLOBES OR GLASS BREAKAGE DUE TO IMPACT

In case of fractured glass do not use your appliance.

## WARRANTY REGISTRATION

Please complete warranty details below and retain together with your proof of purchase document. These documents will need to be viewed by our Service Representative should you request in warranty service.

## SERVICE ASSISTANCE

To assist you when phoning our After Sales Service number to arrange a service call please complete the following details and have them ready when you call.

Model Number \_\_\_\_\_ Date of purchase \_\_\_\_\_

Kleenmaid Store purchased from \_\_\_\_\_ Date of installation \_\_\_\_\_

**KLEENMAID AFTER SALES SERVICE**  
**1300 652 100**





**Other products available in the Kleenmaid  
Range of appliances**

**Washers**

**Dryers**

**Dishwashers**

**Ovens**

**Cooktops**

**Outdoor Cooking Centres**

**Built In Espresso Coffee Machines**

**Rangehoods**

**Freestanding Ranges**

**Sinks**

**Waste Disposals**

**Taps**

**Cookware**

**Refrigerators**

**Freezers**

**Wine Cellars**

**Vacuum Cleaners**

**For sales information on the full range of quality appliances  
Phone 13 13 08**

 **Kleenmaid**  
The best you can own.