

OVEN

c o l l e c t i o n

Instructions for Use and Warranty Details

Multifunction Ovens

TO90S - Stainless Steel

TO91W - White

TO92B - Black



KLEENMAID
THE WORLD'S BEST





Congratulations on the purchase of your new Kleenmaid appliance. This appliance has been designed and manufactured to give you years of reliable performance. For best results, carefully read the instructions on how to install your new appliance. Correct installation will avoid delays and unnecessary service calls.

Once installation is complete, read this booklet and get to know the controls and the features of your new appliance.

**If you need further information call our
Customer Care Centre
1300 652 100**

We reserve the right to alter the specifications with no influence on the operation of the appliance. This instruction manual cannot be reason for claim.

CONTENTS

- General description.....2
- Oven operation.....4
- Timer operation.....5
- Removing roasting trays6
- Practical advice.....7
- Tables9
- Defrosting11
- Cleaning12
- What to do if.....14
- Installation14
- Wiring Diagram16
- Warranty and Service.....17

WARNING

Before using the oven for the first time, it should be switched on using the program  at 250°C for half hour. This will eliminate any remains of grease from the manufacturing process. Then, clean it with soap and water.

High temperatures are reached inside the oven during cooking. Do not let children near it.

Technical data and oven identification information are given on the data plate. This is located on the front of the oven. This plate should be consulted before making any electrical connections.

IMPORTANT: Electrical connections and repairs must be made by a specialist familiar with the legal requirements and standards in your State.

GENERAL DESCRIPTION

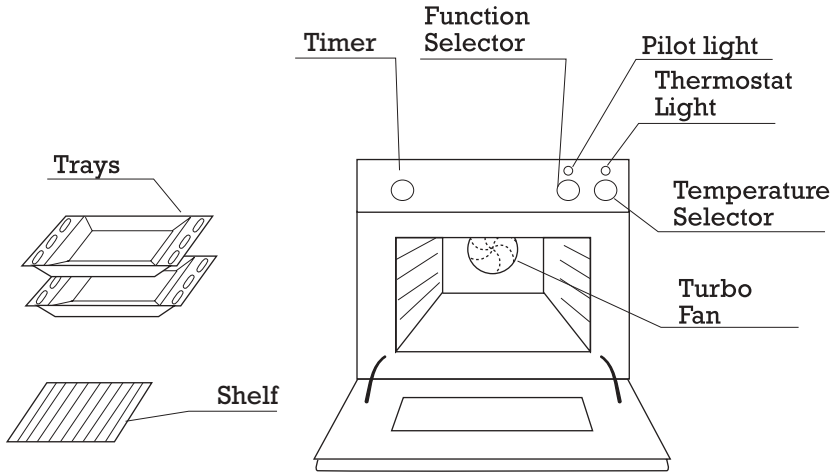

MANUAL TIMER

Functions: end cooking time, manual operation and buzzer.

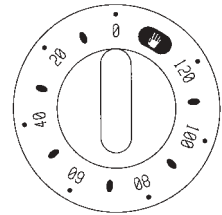

FIXED CONTROLS

The controls cannot be hidden and are designed for ease of use.

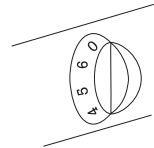

TEMPERATURE SELECTOR

This is used to select the cooking temperature, whether regular or grill (See tables). The thermostat light switches off when the temperature is reached and switches on and off during cooking to maintain the chosen temperature.

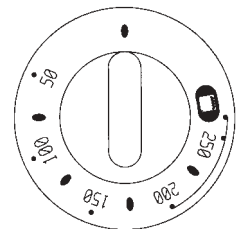

GENERAL DESCRIPTION

PROGRAMME SELECTOR

This allows you to select oven heating programmes (See tables).
The pilot light comes on when ever a programme is selected.



Conventional heat: Heats from above and below, in the conventional way.



Half grill: For grilling the centre of the tray, only for small items.



Full grill: For grilling the entire area of the tray.



Fan forced plus grill: For grilling and roasting, spreading the heat with a fan.



Fan forced plus traditional heat: Heats from below and in the centre, spreading the heat with a fan.

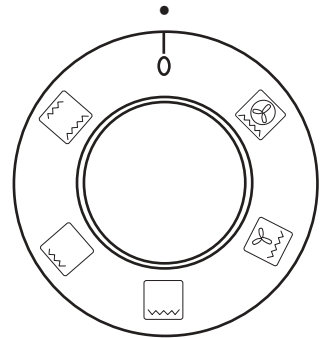

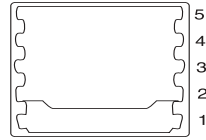

OVEN OPERATION

- 1** Place the food into the oven on the tray at the recommended height .
(See tables)

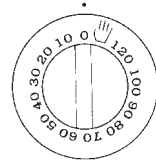

- 2** See "Timer Operation".



- 3** Select the heating method using the program selector.
For example:  (See tables).

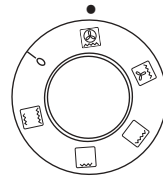

- 4** Select the cooking temperature or the grill temperature using the temperature selector.
For example: 150°C (See tables).

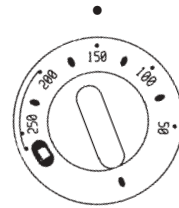

- 5** When cooking ends, set the program and temperatures selectors to zero. (0 and ●)

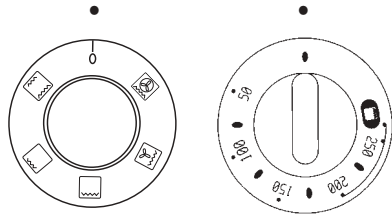

NOTE: The oven must always be used with the door closed for all programmes, including grill.

TIMER OPERATION

TIMER MANUAL

Turn the control clockwise to the time required (For example: 50 min). Proceed to turn on the oven. (See "Oven Operation").

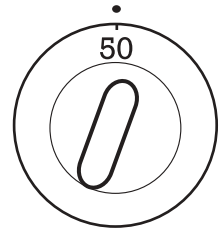

When control reaches 0, a buzzer will sound and the oven will switch off. With the control set at 0 the oven cannot be switched on. (Child safety).

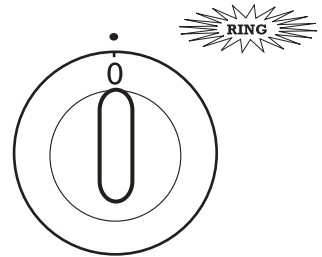

If you wish to use the oven without the timer, set to  .
The oven can be operated for an unlimited time

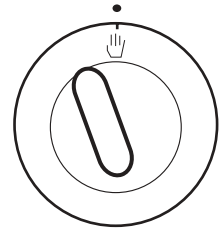

REMOVING ROASTING TRAYS

- 1** First insert the tray carrier shelf ① in the position shown in the figure.

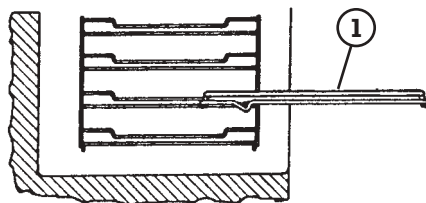

- 2** Then insert tray ② in the upper part of the shelf ① in the position shown in the figure.

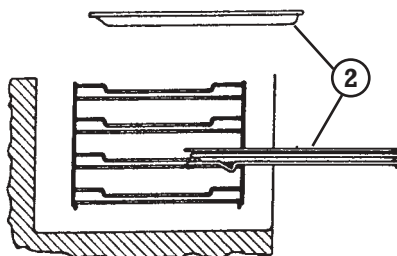

- 3** Fit the assembly into the oven.
To remove the trays once cooking has ended, pull the tray carrier shelf fully outwards and then either:
1. Remove the tray from the shelf.
 - or
 2. Remove the entire assembly by slightly lifting the shelf over the stops that prevent it from falling.

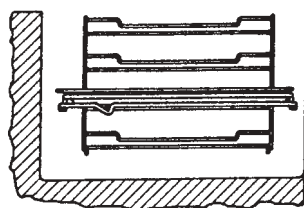

- 4** The shelf and tray assembly can be placed in any of the four levels, taking into account its position as shown in the figure:

1. Shelf
2. Tray

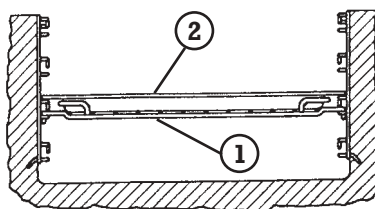

PRACTICAL ADVICE

Always use the tables in this book as a reference for programming your oven. Even if you are cooking to your own recipe, the entry for a similar type of food will help you to choose the programme, temperature and tray position.

CONSULT THE TABLES

The cooking times are guidelines and will be longer if the food is placed into the oven directly from the fridge. The times will also depend on your own personal taste, whether you prefer it rare or well done.

GUIDELINE TIMES

Single piece and very large items require longer times. The tables are designed for quantities for 4 persons.

TABLES FOR 4 PERSONS

Use the temperatures in the tables. A temperature higher than that given may cause excessive steam and smoke.

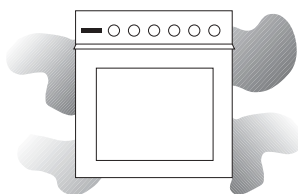

Do not place food or containers directly on the floor of the oven. Always use the tray or shelf.

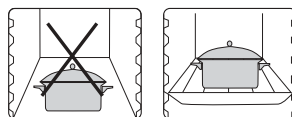

Place the tray under the grill for roasting and baking. This way, all the juices will fall on the tray and the oven will keep clean. The oven should preferably be pre-heated for 10 minutes, especially for and fish.

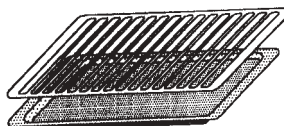

PRACTICAL ADVICE

With deserts, test cakes by pricking with a rod in the centre. If no mix adheres to the rod when it is withdrawn, the cake is ready.

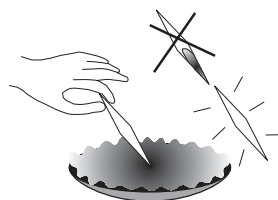

If the mix sinks, use a temperature which is 10° lower next time.

-10°C

If the underside of the cake is overdone, next time place the cake on a higher level in the oven. By contrast, if the top of the cake is overdone, next time place it on the level below.

-10°C

In both cases, you should select a lower temperature.

Allow meat and poultry to rest for 5 to 10 minutes inside the oven, once cooking has finished.

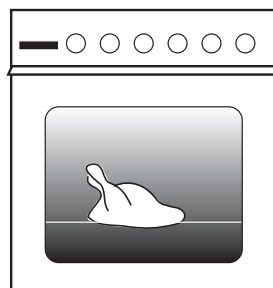













































Always use the grill with the oven closed. If the food does not occupy the entire tray, place it in the centre. Poultry will be browned well if basted.























































DON'T USE ALUMINIUM FOIL ON THE BASE OF OVENS

The use of aluminium foil on the base of the oven to collect spills and improve cleaning is not recommended. Foil or dishes with reflective qualities must never be placed on the base of the oven during cooking as the concentration of the direct and reflected heat will damage the enamel surface. Damage resulting from such use is not covered under the provisions of the warranty.

TABLES

FOOD	PROGRAMME	TEMPERATURE	TIME	POSITION	PRE-HEAT	ACCESSORIES
ENTREES AND VEGETABLES						
Baked eggs		225 °	5 min		NO	
Cantalopes		200 °	20 min		NO	
Baked cauliflower		225 °	10-12 min		YES	
Baked potatoes		225 °	45-50 min		NO	
Baked peppers		200 °	30-35 min		NO	
FISH AND SEAFOOD						
Roast		210 °	15-18 min		YES	
Baked fish		225 °	10-15 min.		YES	
Roast fish		250 °	30-35 min		NO	
Trout		210 °	12-14 min		YES	
Baked bream		210 °	25-30 min		YES	
Sole		225 °	6-10 min		YES	
VARIOUS						
Pizza		200 °	30-35 min		NO	
Turnover		200 °	25-30 min		YES	
Bread		225 °	25-30 min		YES	
Cakes		200 °	12-14 min		YES	

TABLES

FOOD	PROGRAMME	TEMPERATURE	TIME	POSITION	PRE-HEAT	ACCESSORIES
MEAT AND POULTRY						
Whole sirloin		175 °	60-70 min		NO	
Beef ribs		150 °	90-110 min		NO	
Roast lamb		175 °	60-70 min		NO	
Rabbit in sauce		175 °	45-55 min		NO	
Roast beef		150 °	70-80 min		NO	
Ox tail		200 °	120-140 min		NO	
Roast pork, 1kg		150 °	50-60 min		NO	
Roast chicken		200 °	45-50 min		NO	
Roast turkey		190 °	140-160 min		NO	
Duck à l'orange		210 °	90-100 min		NO	
Roast quail		225 °	7-10 min		YES	
DESERTS						
Apple pie		190 °	40-45 min		NO	
Pears in wine		225 °	45-50 min		NO	
Cream caramel		175 °	30-35 min		NO	
Soufflé		200 °	10-12 min		YES	
Biscuit		180 °	30 min		YES	
Baked apple		175 °	30-35 min		NO	
Pastry		175 °	30-35 min		YES	

DEFROSTING

Always place food to be defrosted on the shelf at level 2.

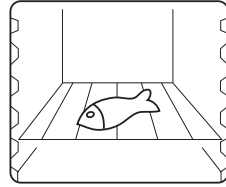

Use the  programme to defrost.
Set the thermostat knob to “●”

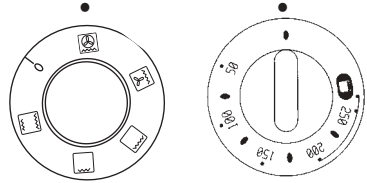

Rather than leaving your food items to defrost slowly in your kitchen, you can use your ‘Fan Forced with Traditional’ function to defrost your items quicker. Simply turn the dial to the function and place your food items on the grilling/oven rack. Temperature selection is not necessary for effective defrosting. Suggested items: Bread, fish, raspberries and flat packed meats.

DEFROSTING TABLE

FOOD	WEIGHT	TIME	PIECES
MEAT			
Round	1,000 g.	90 min	1
Filletts	400 g.	20 min	4
Minced meat	1,000 g.	60 min	1
Chopped meat	1,000 g.	70 min	20
Whole chicken	1,200 g.	70 min	1
Chicken pieces	1,200 g.	40 min	20
Sausages	500 g.	25 min	12
Loin, pieces	1,000 g.	90 min	1
Loin in fillets	450 g.	40 min	8
FISH			
Hake	800 g.	60 min	1
Filletts	480 g.	20 min	4
Small fish (mullet)	700 g	30 min	
Tuna in slices	1,200 g.	25 min	2
Prawns	1,000 g.	30 min	40
VARIOUS			
Mixed vegetables	400 g.	20 min	
Bread, cakes, etc	250 g.	10 min	
Pre-cooked food	500 g.	30 min	

CLEANING

Never use sandy or abrasive detergents. Clean the oven exterior with a soft damp cloth using soapy water.

WATER + SOAP



All the panels inside the oven, except for the floor and ceiling, are covered with self-cleaning enamel.

These panels eliminate small splashes of grease during cooking without the need to clean them.

Some large splashes may not disappear immediately; after removing the cooked food, leave the oven at 250°C for half hour. (Do not let children near it).

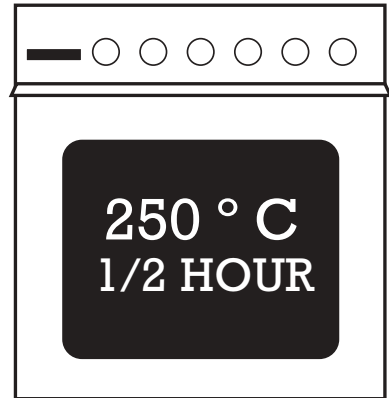

However, if there is heavy splashing, panels must be washed.

To make cleaning easy, the side panels are also removable. Cleaning can be made in dishwasher or by hand, with warm water and a non-metallic sponge.

Instructions to remove the side panels:

- 1) Push down the upper stick of guides until it is released.
- 2) Turn the guides as shown in the picture and pull out. The guides will be free.
- 3) Take the panel down.

Oven back can also be removed by loosening the screws.

NOTE: Do not use special sprays on self-cleaning ovens.

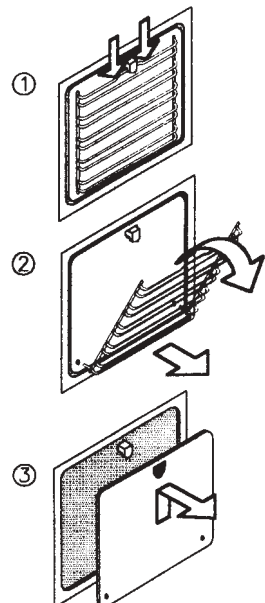

CLEANING

The door may also be removed to facilitate cleaning. Carefully follow these steps in order not to cause a fault.

Open the door downward and turn the latch of the hinges as shown in the diagram.

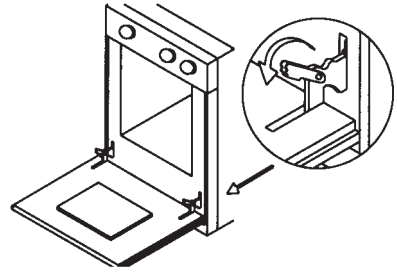

Close the door smoothly until it stops. Then, holding the door with both hands, pull upward and continue closing it until the hinges come out from their slots. The door will then be free.

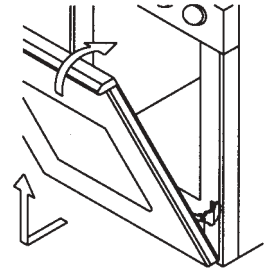

To replace the door, fit the hinges fully home in their slots, as shown in the diagrams.

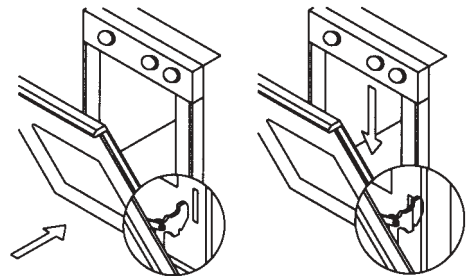

Open the door downward and turn the latch to their original position. The door is now installed.

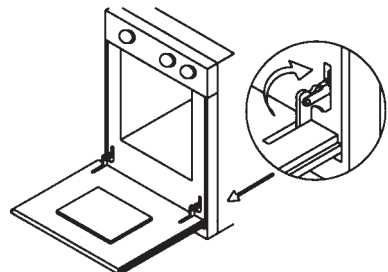

WHAT TO DO IF...

The oven does not switch on and the programmer's display does not light up.

- Fuses blown. Replace them.
- If the fuses blow again, too many devices are running!
- If the oven still does not work, call Kleenmaid Customer Call Centre.

The oven does not switch on and the programmer is flashing 0.00.

- Probably there has been a power cut. Adjust the time on the programmer and repeat the switching on of the oven.

The light does not work even though the oven is on.

- Probably the light bulb has blown. When the oven is cold, unscrew the lamp cover, remove the bulb and replace it with another (switch off at the mains first, for safety reasons).

The oven fills with smoke coming from the oven itself.

- All ovens produce smoke to a greater or lesser extent. This is normal, especially for roasts.
You can reduce the smoke by reducing the amount of fat or liquid in the tray and by using the oven at a rather lower temperature from now on. Do not use temperatures which are higher than those shown in the tables.
- The grill element may be dirty, with grease from a previous roast. When the grill is switched on, this grease will be burnt and much smoke will be created for a few minutes. Try to keep the grill clean.

INSTALLATION

UNPACKING

Carefully remove all the elements protecting the apparatus. The two brackets "A" in two parts of the oven must also be removed, as shown in the figure.

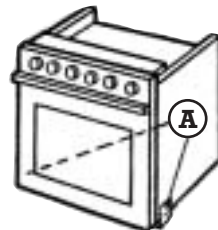

INSTALLATION

The measurements of the holes in the kitchen unit must be as shown in the figures, for tower or under bench mounted units.

It is very important to maintain the ventilation holes at the back in order that the oven operates correctly.

See the Kleenmaid Technical Specification Brochure for specific instructions on mounting underbench and tower installation.

The electrical circuit must be correctly earthed.

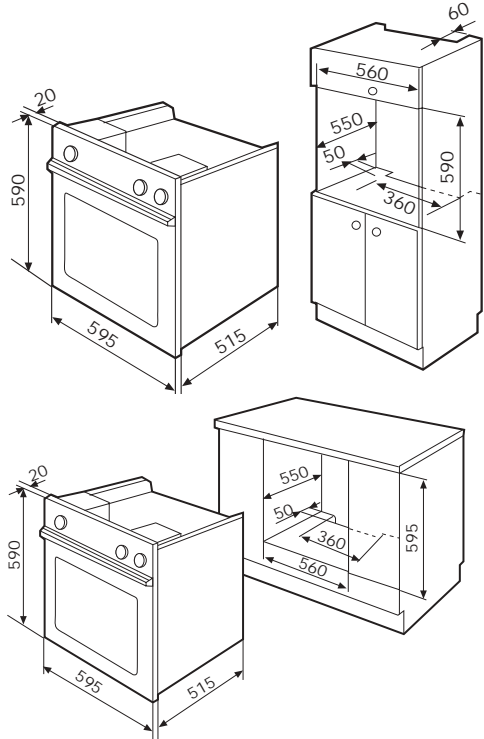

Once wiring is connected, fit the oven into the unit, taking care not to leave any excess cable lying on top of the oven.

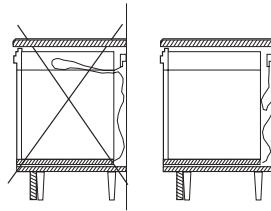

Fix the oven to the unit with 4 screws (included in the oven packaging inclusions).

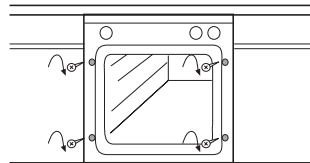

WIRING DIAGRAM

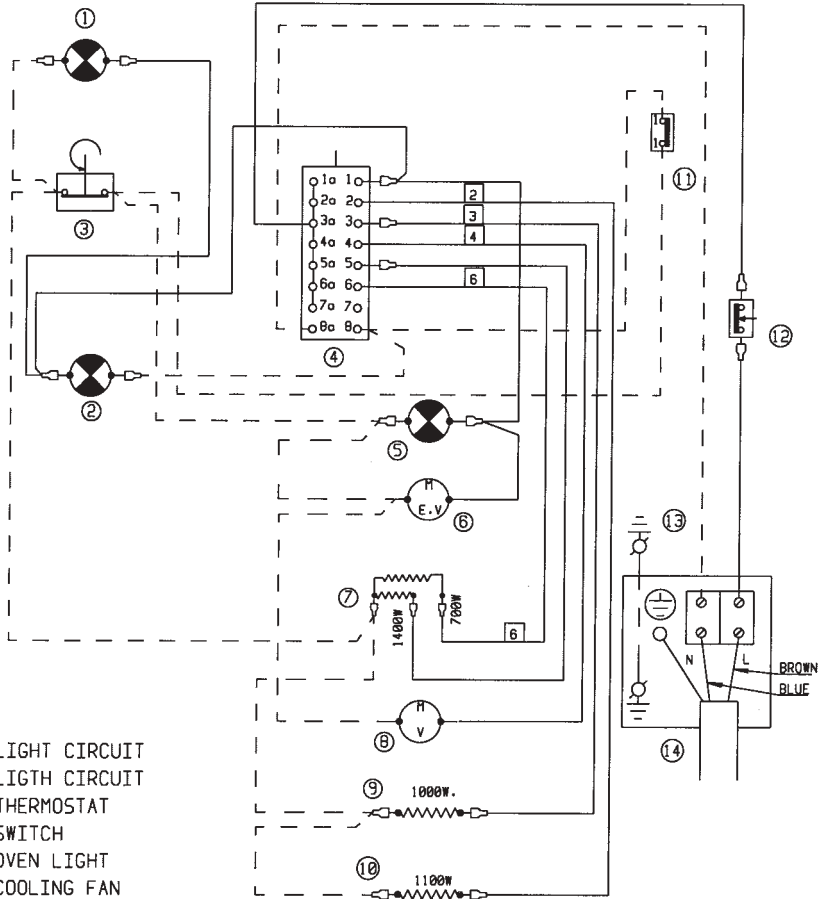

1. LIGHT CIRCUIT
2. LIGH CIRCUIT
3. THERMOSTAT
4. SWITCH
5. OVEN LIGHT
6. COOLING FAN
7. UPPER HEATING ELEMENT
8. FAN OVEN
9. CIRCULAR HEATING ELEMENT
10. BOTTOM HEATING ELEMENT
11. TIMER
12. SAFETY THERMOSTAT
13. EARTH
14. MAIN BLOCK

= GREEN-YELLOW COLOUR
 = RED COLOUR
 = BLUE COLOUR
 TERMINAL WITH COVER



	1a	2a	3a	4a	5a	6a	7a	8a
	1	2	3	4	5	6	7	8
0								
1	X	X				X		X
2	X				X	X	X	X
3	X				X	X	X	X
4	X			X	X	X		X
5	X	X	X	X				X

WARRANTY AND SERVICE

DOMESTIC WARRANTY - FULL FIVE YEAR WARRANTY

In addition to all statutory rights which you, the Consumer, have under the relevant laws in respect of this appliance, during the first five years of ownership as the original purchaser of this Kleenmaid appliance, we guarantee that any fault caused by faulty material or workmanship becoming apparent will be rectified free of charge for parts and labour, provided that all service is performed during normal working hours by Kleenmaid or their designated Agents. Where the appliance is installed outside the normal servicing area of the above, the Purchaser must pay for the cost of transporting the appliance to and from the Agent or the Agent's travelling cost to and from the Purchaser's home.

COMMERCIAL WARRANTY - ONE YEAR WARRANTY

When this appliance is installed in a commercial application, you, the Consumer, have under the relevant laws in respect of this appliance, during your first one year of ownership as the original purchaser of the Kleenmaid appliance, we guarantee that any fault caused by faulty material or workmanship becoming apparent, will be rectified free of charge for parts and labour, provided that all service is performed during normal working hours by Kleenmaid or their designated Agents. Where the appliance is installed outside the normal servicing area of the above, the Purchaser must pay for the cost of transporting the appliance to and from the Agent or the Agent's travelling cost to and from the Purchaser's home.

WHAT THESE WARRANTIES DO NOT COVER

We are not responsible for any damage or malfunction unless caused by a defect in material or workmanship. This includes but is not limited to abuse, misuse, improper installation and transportation damage. We are not responsible for any consequential damages from any malfunction.

WARRANTY DOES NOT COVER REPLACEMENT OF LIGHT GLOBES OR GLASS BREAKAGE DUE TO IMPACT

In case of fractured glass do not use your appliance.

WARRANTY REGISTRATION

Please complete the enclosed warranty card and post it to us or phone our Customer Call Centre.

SERVICE ASSISTANCE

To assist you when phoning our Customer Call Centre number to arrange a service call please complete the following details and have them ready when you call.

Model Number: _____ Date of purchase: _____

Kleenmaid Store purchased from: _____ Date of installation: _____

KLEENMAID CUSTOMER CALL CENTRE
CONTACT NUMBER
1300 652 100

Other products in Kleenmaid's range
of world's best appliances:

- Washers
- Dryers
- Vacuum Cleaners
- Dishwashers
- Cooktops
- Cookware
- Rangehoods
- Ovens
- Refrigerators & Freezers
- Sinks & Taps
- Waste Disposals

**For sales information on the full range of quality
kitchen and laundry appliances, phone 13 13 08**

Kleenmaid Head Office:

PO Box 5560, Maroochydore Business Centre, Queensland 4558



Printed on recycled paper.