

Cooking

c o l l e c t i o n

Instructions for fitting and using  
your mixed induction-ceramic  
and  
Warranty Details

IVK61-600mm Induction-ceramic Cooktop



**220-240 V 50Hz**

REF CONSTRUCTEUR 214

Congratulations on the purchase of your new appliance.  
This appliance has been  
designed and manufactured to give you years  
of reliable performance.

For best results, carefully read the instructions on how to  
install your new appliance. Correct installation will avoid  
delays and unnecessary service calls.

Once installation is complete, read this booklet  
carefully and get to know the controls and the  
features of your new appliance.

We reserve the right to alter the specifications  
with no influence on the operation of the  
appliance. This instruction manual cannot be  
reason for a claim.

# List of contents

|   |       |
|---|-------|
| Using your hob in complete safety.....      | 4     |
| Containers.....                             | 6-7   |
| Installing your hob in complete safety..... | 8     |
| Using your hob in all simplicity.....       | 10    |
| Preserving and maintaining your hob.....    | 12    |
| Small problems and solutions.....           | 13    |
| Cooking .....                               | 14-15 |

*In this Manual,*



*displays safety*

*instru displays tips and hints*



## Using your hob in complete safety

For saucepans

### Overheat sensor

- Each unit is equipped with a sensor that continuously monitors the temperature of the bottom of the pan, so that overheating is impossible (empty saucepan, etc.).

For the hob

- A sensor continuously monitors the temperature of the components of your hob. The power output by the hob will automatically be reduced if this temperature becomes excessive.

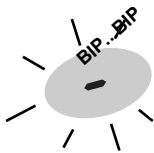

### Overflow protection

The shutdown of the hob, a special display (symbol shown opposite) and an audible "beep"\* can all be triggered in one of the three following cases:

- An overflow which covers the control buttons.
- A damp cloth being placed on the buttons.
- A metal object being placed on the control buttons.

Clean or remove the object and start cooking once again.

\* depending on the model

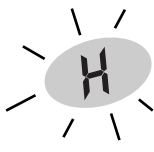

### Residual heat indicator

After intensive use, the cooking zone may remain hot for several minutes.

The letter "H" is displayed during this period. Do not touch the zones concerned.

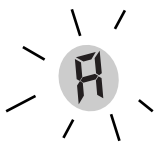

### Auto-stop system

The "Automatic-Stop" function activates automatically if the user forgets to turn off the cooker after cooking.

It starts up automatically if ever you forget to turn off after cooking

The letter **A** is displayed for the heating zone concerned and the hob will bleep for about 2 minutes. The **A** will continue to be displayed until any control of the zone in question is touched. The hob will then bleep twice to confirm your action.

| 4<br>Power used | the heating zone<br>goes out automatically<br>after: |
|-----------------|--|
| Between 1...4   | 8 hours  |
| Between 5...7   | 2 hours  |
| Between 8...9   | 1 hour   |

## Keypad lock

Your cook top is equipped with a child safety feature which locks it during the use:

- Either when stopped (for cleaning)
- Or during cooking (any operations underway will continue and the displayed settings remain active).

this case, for safety reasons only the "**STOP**" button is still usable.

**Don't forget to unlock the appliance before reusing it.**

### Locking the appliance



Choose the specific touch for locking, press this touch until information is displayed on the screen. 

The display goes out after a few seconds.  
Pressing any of the buttons activates the display.

### Unlocking the appliance



Press locking touch until lights out.

## Automatic saucepan detection

Your induction hob is able to recognise most recipients.

- Test recipient: place your recipient on one of the rings on power setting **4**.

If the display remains unchanged, your recipient is compatible.

If it flashes on and off, your recipient cannot be used with induction.

- You can also check using a magnet.

If it "sticks" to the base of the recipient, then this recipient is compatible with induction.

Removing the recipient from the hob immediately turns off the power to your hob. To completely turn off the ring you should press on the "Stop" button.

## "Small item" safety feature

A small object such as a fork, spoon or a ring placed on your induction hob by itself is not detected as a pan. The display flashes and there is no output power.

- The appliance is not intended for use by young children without supervision.
- Young children should be supervised to ensure that they do not play with the appliance.

## Your induction hob in complete safety

### The principles of induction

When your induction hob is switched on and a heating power has been selected, the electronic circuits produce induced currents that instantaneously heat the bottom of the pan that transfers this heat to the food.

Thus cooking takes place with **practically no energy loss** between the induction hob and the food.

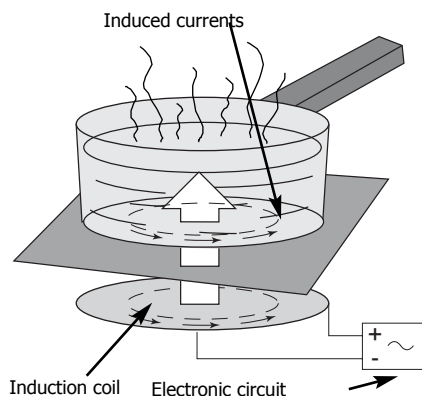

### For the attention of wearers of pacemakers or other active implants:

The hob complies with all current standards on electromagnetic interference. Your induction hob is therefore perfectly in keeping with legal requirements (89/336/CEE directives). It is designed not to create interference on any other electrical apparatus being used on condition that the apparatus in question also complies with this legislation.

Your induction hob generates short-range magnetic fields. To avoid any interference between your induction hob and a pacemaker, the latter must be designed to comply with relevant regulations. In this respect, we can only guarantee our own product conformity. Please consult the pacemaker manufacturer or your doctor concerning its conformity or any possible incompatibility.

- If a crack appears in the glass surface, disconnect the appliance immediately to avoid any risk of electric shock. For disconnecting, remove the fuses or use the cutout switch.  
Do not re-use your hob until the glass surface has been changed.
- Your hob must never be used as a storage space or cutting surface for any products whatsoever.
- ⚠ When cooking never use aluminium foil and never place products wrapped in aluminium foil or products deep-frozen in aluminium packs on the hob.  
The aluminium will melt and damage your appliance irreparably.  
Do not leave empty pans on your hob in case of residual heat or if the hob is turned on by mistake.
- Do not connect electrical appliances on plugs close to the hob. Make sure that the power cable is not in contact with any heating zones.
- ⚠ A steam cleaner must not be used.

## Induction pan area

You probably already have some suitable pans.

Your induction hob is able to recognize most types of pans.

Pan test: Place your pan on a zone, for example at position 4; you know that your pan is compatible if the display does not flash, but if it does flash then you cannot use this pan for induction cooking. You can also test it with a magnet: if the magnet "sticks" to the base of the pan, then you can use it for induction cooking.

### Pans compatible with induction are:

- pans made of enamel coated steel with or without a non-stick coating.
- cast iron pans with or without enamel coated base.

An enamelled coated base will prevent the glass top of your hob from getting scratched.

- stainless steel pans designed for induction cooking.

Most stainless steel pans (saucepans, stewpans, frying pans, deep frying pans, etc.) are suitable for induction cooking if they pass the pan test.

- aluminium pans with special base. pans which do not have a flat base may be suitable, however they must not be badly deformed.

Choose a pan marked with the **class INDUCTION** logo on its base or packaging to be sure that it is perfectly suitable for use on your induction hob under normal conditions of use.

A list of utensils is supplied with these instructions to help you make your choice.

### Note

Glass, ceramic, earthenware pans, aluminium pans (without a special base) and copper pans, and some non-magnetic stainless steel pans are incompatible with induction cooking. You will be informed by the flashing display.

**You should choose pans with a thick flat base for uniform cooking (heat is better distributed).**

## Using the cooking zones according to the pan (depending on the model)

Multi-service zone

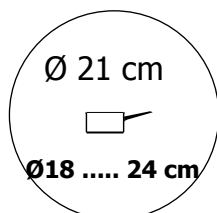

For small pans

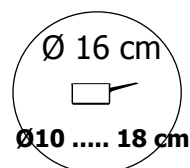

Slow cooking (sauces, creams...).

Preparing small quantities or individual portions...

## Vitroc ceramic pan area

Pans and casseroles must be designed for use with electric hobs.

Use pans with flat bases that have good surface contact with the cooking zone surface. They must be made out of:

- Stainless steel with a thick tri-metal or "sandwich" bottom.
- In aluminium with a thick smooth bottom.
- In enamelled steel.

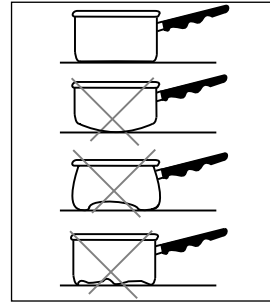

## The best way to use your ceramic hob

For easy use, we have provided cooking zones specially adapted to your needs, nevertheless:

**However, higher temperatures may be required for:**

- Large quantities
- Cooking with a non-covered casserole.
- Using a glass or ceramic casserole.

**And lower temperatures are required for:**

- Cooking food products that tend to burn easily (start with a low temperature that can always be increased if possible).

- In case of overflowing (take the lid off, or remove the pan from the heat, then lower the temperature).

### Energy saving:

To finish off cooking touch the control and reduce back to **0**. Leave the pan in place to use up all the accumulated heat (which saves energy).

Use a lid whenever possible to reduce any loss of heat through evaporation.

### Automatic cooking zone temperature adjustment

**The radiant cooking zone is self-regulating**, It switches itself on and off so as to remain at the programmed power. Under these conditions the temperature remains constant and is correctly adapted to the food you are cooking.

The frequency of self-regulation depends on the power being used.



## Installing your hob in complete safety

Always ensure that the air vents beneath the hob are kept clear.  
Your induction hob must always be adequately ventilated.

### Above a cupboard or drawer unit

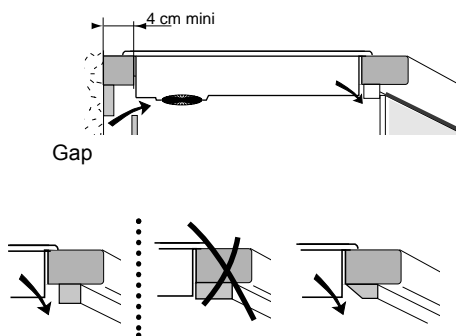

Ensure that the unit crossbar does not block the air passage, make a bevel if necessary.

### Above an oven

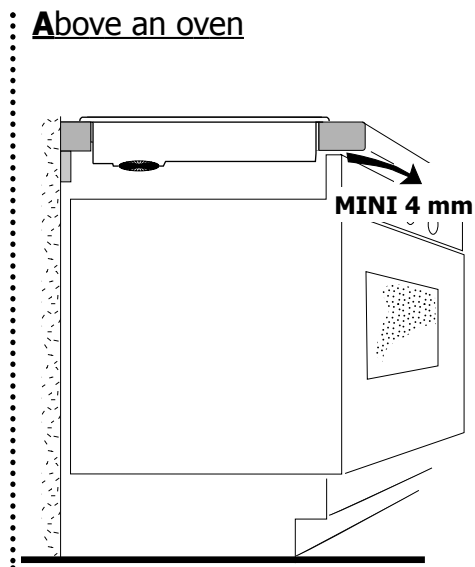

### **If the appliance underneath your hob produces excess heat :**

this will be detected by a safety device incorporated into your induction hob. A high temperature will be indicated by a **series of dashes** or **F7** will appear in the display.

If this happens we suggest you either create an opening in the side of the unit and/or install an insulation kit available from the After-Sales Dept (ref 75X1652), which will protect your hob from the heat generated beneath it.

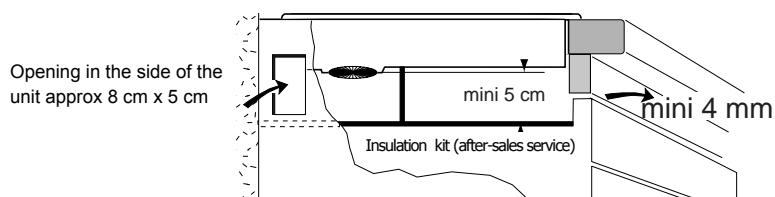

Providing the advice on ventilation given above is followed, your hob can be installed above any piece of kitchen equipment.

## Installing your hob in complete safety

### Fitting

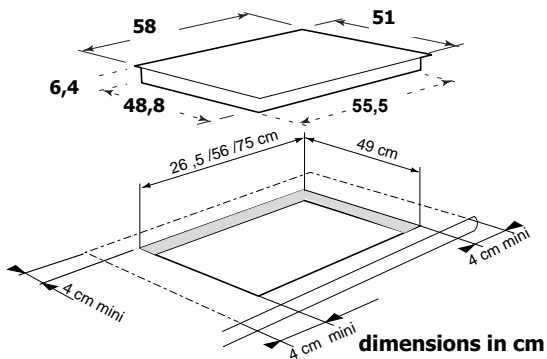

A seal exists for preventing any humidity getting under the hob.  
 -Stick the seal under the rim of the hob and lower the hob into position on the worktop.  
 -This seal is supplied in the sachet; stick it in place beneath the hob.

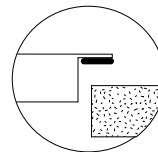

The unit must be installed so that the mains plug is easily accessible.

### Connection

These hobs are delivered with type H 05 VVF power cable (1.5mm<sup>2</sup>) with 3/5 conductors (including a green/yellow earth wire), which must be connected to the power supply via a plug that complies with publication CEI 60083 or an all-pole cut-out unit with contacts that open by at least 3mm. If the cable is damaged, it must be replaced by the manufacturers, their After Sales Service or another similarly qualified person for avoiding any possible risk of accident.

When the power is switched on, or after a long power failure, a light code appears on the control panel. This disappears automatically after about 30 seconds or as soon as any touch control is touched on the panel. This is normal, as the display is for use by the after-sales service when required. The user must not take this into account under any circumstances. If the unit has a 3 phase 400 V2N connection, and is not working correctly, check that the neutral wire is correctly connected. This precaution should also be taken for all your other electronic apparatus.

"When installing the cooktop, precautions must be taken to avoid damaging the power cable with the sharp edges"

**- 220-240 V monophase  
fuse 32**

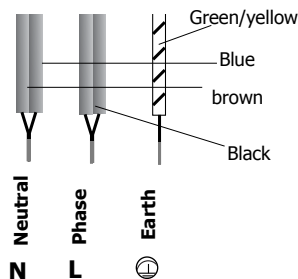

**- 400 V 2N three-phase  
fuse : 16 Amp**

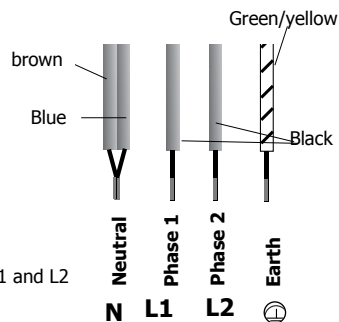

Separate the 2 phase wires L1 and L2 before connecting

## What your hob looks like?

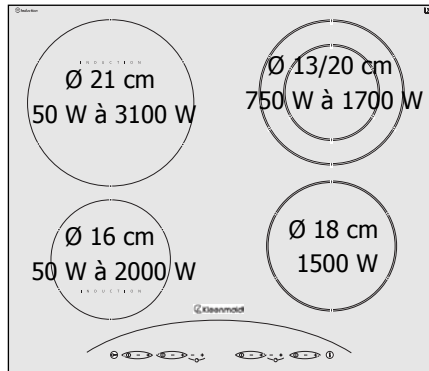

**TI 315**

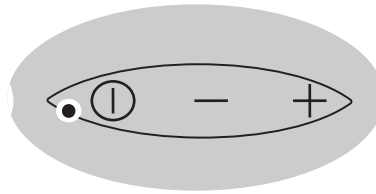

### Start/Stop

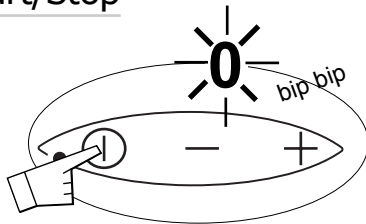

The hob bleeps and a **0** blinks to indicate that the zone concerned has been turned on; you can then select the power you require. If you do not request any power the heating zone will turn itself off automatically.

**⚠** The two induction zones have a **total power of 3100 W, which is divided up automatically** between them.

This implies, for example, that using maximum power in one zone will lead to the other zone's power being reduced automatically which will be shown on the power display.

***The last instruction always has priority.***

### Setting manual power

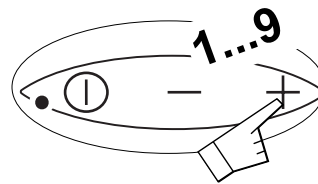

### General stop button

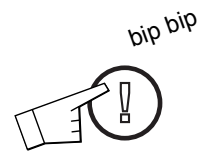

The general stop button turns off all cooking zones

## Using your hob in all simplicity

### Setting the timer\*

depending on the model

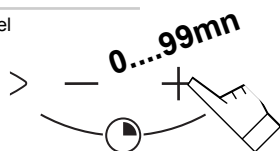

Operates when cooking zones concerned are working. You can modify cooking times and any time.

#### manual stopping

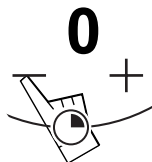

#### automatic stopping

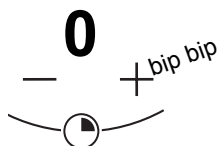

To stop the beep touch any control key in the cooking zone concerned. It will stop by default after about 1 minute.

### Additional zone

#### To start it up:

Turn on your main cooking zone.

Press down on the "extra" touch control, a light will come on and the hob will beep to confirm that the extra zone has been turned on.

Adjust the zone to the heat you require.

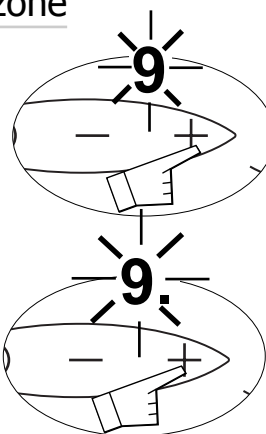

#### To turn it off:

Press down on the on / off touch control, then set the power you require.

Cutting off power to the main zone automatically cuts off the extra zone.

## Preserving and maintaining your hob

● You must:

**Avoid any shocks** with pans:

The glass surface is highly resistant but not unbreakable.

**Avoid rubbing** with any abrasive or with the base of pans etc. as in time this will deteriorate the markings on the top of your ceramic hob.

**Avoid using pans with rough or dented bases:**

They may hold and transport matter liable to stain or scratch the hob.

**Any such faults, which are not the cause of breakdowns nor make the hob impossible to use, are not included in the guarantee conditions.**

**Place** your pan **in the middle** of the heating zone.

**Use** a pan of the right size. The diameter of the base must be as big as, or bigger than the cooking zone surface area marked on the ceramic plate.

It is very easy to clean your hob, especially if you follow these few recommendations:

● You must not

Leave metal cooking utensils, knives and forks, or metal objects on the hob. They will get hot if left close to any heating zone that is in use.

**Store MAINTENANCE or INFLAMMABLE** products in the cupboard under your hob.

**Leave an empty** pan on a heating zone.

**Heat up a closed can. It may burst;** this

recommendation applies to all methods of cooking.

Preheat at maximum temperature when using pans with non-stick inside surfaces (Teflon type).

Use very little or no fat at all.

The maximum heating position is for boiling and frying only.

| TYPE OF STAIN  | WHAT TO DO  | ACCESSORIES EMPLOYED                         |
|--|---|--|
| Minor  | Soak the area to be cleaned with hot water, then wipe it.   | Clean sponges                                |
| Accumulated burnt-on stains  | Soak the area to be cleaned with hot water, use a special ceramic hob scraper to remove the worst, finish off with the rough side of a cleaning sponge, then wipe it clean. | Clean sponges<br>special ceramic hob scraper |
| Rings and traces of limescale  | Apply hot white spirit vinegar on the stain, leave to act then wipe off with a soft cloth.- Use a commercial cleaner.   | Special ceramic hob cleaner                  |
| Burnt-on stains following sugar spillage, melted aluminium or plastic. | - Apply a special ceramic hob cleaner on the surface, preferably one which contains silicone (protective action).   | Special ceramic hob cleaner                  |



powder



abrasive-backed sponge





cream



ordinary sponge or special sponge for delicate items

## Minor troubleshooting

**You have doubts about whether your hob is working correctly .... this does not necessarily mean there is a breakdown. Nevertheless, check the following points**

| IF YOU REALIZE THAT   | POSSIBLE CAUSES   | WHAT SHOULD YOU DO?   |
|---|---|---|
| <i>When you switch on, the display lights up</i>  | <i>The hob is working normally</i>  | <i>NOTHING: see chapter Remarks on connections</i>  |
| <i>When you switch on, the fuse blows</i>   | <i>Your hob is connected incorrectly</i>  | <i>Check the connection and make sure it complies with requirements.</i>                                      |
| <i>When you switch on, only one side of the hob works</i>   | <i>Your hob is connected incorrectly</i>  |   |
| <i>The fan keeps going for a few minutes after the hob has been switched off</i>  | <i>The electronics are cooling down</i>   | <i>This is normal.</i>  |
| <i>The top of the hob is always warm (even when it is switched off).</i>  | <i>The electronics are under power as for all other electronic apparatus (TV, transformers, etc.).</i>                      | <i>This is normal.</i>  |
| <b>The hob does not work.</b> <i>Displays on the keyboard do not come on</i>  | <i>The apparatus is not under power. There is a power or connection problem.</i>  | <i>Inspect the fuses and the cut-out switch.</i>  |
| <i>The hob has stopped during use and is giving out a bleep every ten seconds and a  (or F7) appears on the display.</i> | <i>Something has overflowed and or an object is touching the control panel.</i>   | <i>Clean the hob or remove the object in question and start cooking again.</i>                                |
| <i>A series of little  (or F7) appears</i>   | <i>Electronic circuits have overheated.</i>   | <i>See "Fitting your hob".</i>  |
| <b>The hob does not work,</b> <i>another message comes on</i>   | <i>The electronic circuit is working badly.</i>   | <i>Call the After Sales Service</i>   |
| <i>After having turned on a heating zone, the keyboard displays continue to flash.</i>  | <i>The saucepan you use is unsuitable for induction cooking or its diameter is under 12 cm. (10 cm on the 160 mm zone).</i> | <b>See containers.</b>  |
| <i>The pans make a noise during cooking</i>   | <i>This comes from vibrations made by energy going from the hob to the pan.</i>   | <i>Under high power this phenomenon is normal with certain types of pans. There is no danger for the hob.</i> |
| <i>The hob gives off a smell when first used for cooking</i>  | <i>A new apparatus</i>  | <b>Use each heating zone for ½ hour with a pan full of water.</b>   |

**If the slightest break or crack appears in the ceramic glass surface, disconnect the unit immediately and contact your After Sales Service.**

| DISHES  | FRYING<br>BRINGING TO THE BOIL |   |   | COOKING/BROWNING<br>BRINGING BACK TO THE BOIL<br>STEADY SIMMERING |   |   |   |   | COOKING KEEPING<br>SIMMERING WARM |  |  |
|---|--------------------------------|---|---|---|---|---|---|---|-----------------------------------|--|--|
|   | 9                              | 8 | 7 | 6   | 5 | 4 | 3 | 2 | 1                                 |  |  |
| <b>SOUPS</b>  |                                |   |   |   |   |   |   |   |                                   |  |  |
| <b>BROTH</b><br><b>THICK SOUP</b>   |                                |   |   |   |   |   |   |   |                                   |  |  |
| <b>FISH</b>   |                                |   |   |   |   |   |   |   |                                   |  |  |
| <b>STOCK</b><br><b>FROZEN</b>   |                                |   |   |   |   |   |   |   |                                   |  |  |
| <b>SAUCES</b>   |                                |   |   |   |   |   |   |   |                                   |  |  |
| <b>THICK, MADE WITH FLOUR</b><br><b>MADE WITH BUTTER AND EGGS</b><br><b>(BEARNAISE, HOLLANDAISE)</b>  |                                |   |   |   |   |   |   |   |                                   |  |  |
| <b>VEGETABLES</b>   |                                |   |   |   |   |   |   |   |                                   |  |  |
| <b>CHICORY, SPINACH</b><br><b>PULSES,</b><br><b>BOILED POTATOES</b><br><b>FRIED POTATOES</b><br><b>SAUTE POTATOES</b><br><b>DEFROSTING VEGETABLES</b>   |                                |   |   |   |   |   |   |   |                                   |  |  |
| <b>MEAT</b>   |                                |   |   |   |   |   |   |   |                                   |  |  |
| <b>THINLY SLICED MEAT</b><br><b>FRYING STEAKS</b><br><b>GRILLING (CAST IRON GRILL PAN)</b>  |                                |   |   |   |   |   |   |   |                                   |  |  |
| <b>DEEP FRYING</b>  |                                |   |   |   |   |   |   |   |                                   |  |  |
| <b>FROZEN CHIPS</b><br><b>FRESH CHIPS</b>   |                                |   |   |   |   |   |   |   |                                   |  |  |
| <b>MISCELLANEOUS</b>  |                                |   |   |   |   |   |   |   |                                   |  |  |
| <b>PRESSURE COOKER</b><br><b>STEWED FRUIT</b><br><b>PANCAKES</b><br><b>CUSTARD</b><br><b>MELTING CHOCOLATE</b><br><b>JAM</b><br><b>MILK</b><br><b>FRIED EGGS</b><br><b>PASTA</b><br><b>BABY FOOD IN JARS (BAIN MARIE)</b><br><b>STEWES</b><br><b>CREOLE RICE</b><br><b>RICE PUDDING</b> |                                |   |   |   |   |   |   |   |                                   |  |  |

maximum power is reserved for frying and quick boiling.

- slow cooking
- fast cooking
- boil or fry
- boil with cover
- add food

| DISHES               | MAXI<br>9   | VERY HOT<br>8-7 | HOT<br>6 | MEDIUM<br>5-4 | SIMMERING<br>REHEATING |   |   | KEEPING<br>WARM |
|----------------------|---|-----------------|----------|---------------|------------------------|---|---|-----------------|
|                      |   |                 |          |               | 3                      | 2 | 1 |                 |
| <b>SOUPS</b>         | BROTH<br>THICK SOUP   |                 |          |               |                        |   |   |                 |
| <b>FISH</b>          | STOCK<br>FROZEN   |                 |          |               |                        |   |   |                 |
| <b>SAUCES</b>        | THICK, MADE WITH FLOUR<br>MADE WITH BUTTER AND EGGS<br>(BEARNAISE, HOLLANDAISE)   |                 |          |               |                        |   |   |                 |
| <b>VEGETABLES</b>    | CHICORY, SPINACH<br>PULSES,<br>BOILED POTATOES<br>FRIED POTATOES<br>SAUTE POTATOES<br>DEFROSTING VEGETABLES   |                 |          |               |                        |   |   |                 |
| <b>MEAT</b>          | THINLY SLICED MEAT<br>FRYING STEAKS<br>GRILLING (CAST IRON GRILL PAN)   |                 |          |               |                        |   |   |                 |
| <b>DEEP FRYING</b>   | FROZEN CHIPS<br>FRESH CHIPS   |                 |          |               |                        |   |   |                 |
| <b>MISCELLANEOUS</b> | PRESSURE COOKER<br>SEWED FRUIT<br>PANCAKES<br>CUSTARD<br>MELTING CHOCOLATE<br>JAM<br>Milk<br>FRIED EGGS<br>PASTA<br>BABY FOOD IN JARS (BAIN MARIE)<br>STEWES<br>CREOLE RICE<br>RICE PUDDING |                 |          |               |                        |   |   |                 |

maximum power is reserved for frying and quick boiling.



slow cooking

fast cooking



boil or fry



boil with cover

add food



**Other products available in the Kleenmaid  
Range of appliances**

Washers

Dryers

Dishwashers

Ovens

Cooktops

Outdoor Cooking Centres

Built In Espresso Coffee Machines

Rangehoods

Freestanding Ranges

Sinks

Waste Disposals

Taps

Cookware

Refrigerators

Freezers

Wine Cellars

Vacuum Cleaners

**For sales information on the full range of quality appliances  
Phone 13 13 08**