

Front Loading Washing Machine KFL806

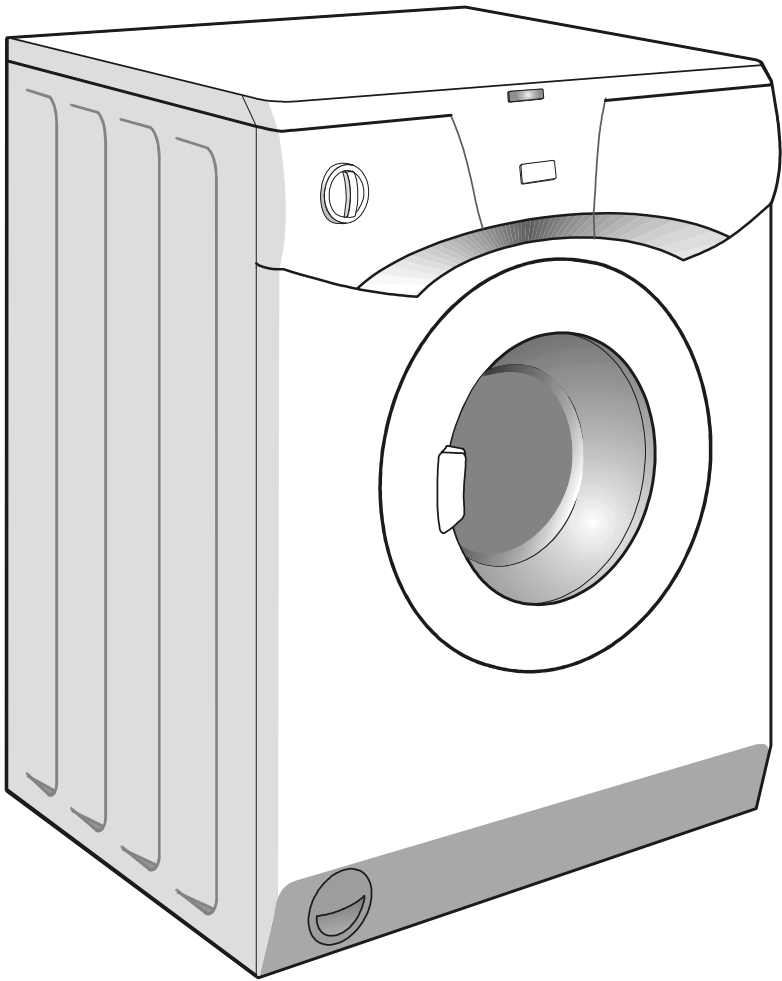

- 1. Before Use 4-5
- 2. Removing the Transport Rods 6
- 3. Placing and Installation -connection to the water supply 7-8
 - connection to hot/cold
 - water outlet
 - connection to power supply
- 4. The door 9
- 5. Preparing the Clothes 10
- 6. Washing agents & How Much to Use 11-12
- 7. Washing Machine Control Panel..... 13
- 8. Table of Washing Programmes 14-15
- 9. Preparing Your Machine For Washing 16
- 10. Stain Removal Guide 17-19
- 11. Cleaning & Maintenance 20-21
 - Trouble Shooting Guide 22

1. Before Use

Please read the manual carefully and get to know your washing machine so that you will know how to use it safely and correctly.

Tips for Energy Savings



Through correct use and consideration of our recommendations, you can make substantial energy savings.

- For economical washing, refer to the *Table of Washing Programmes* (pages 14-15) for recommended wash programmes.
- Skip the pre-wash whenever possible (if laundry is only lightly soiled).
- Laundry which was previously washed at 95°C may be washed at 60°C if either a bleaching agent, or a concentrated washing agent is used.
- Use an adequate washing agent, and always consider the recommended amount (refer manufacturer's instructions), and note the hardness of the water and the degree of soiling.

Important



- Before making use of the machine, don't forget to remove the transport rods. Switching on a machine with the transport rods in place may damage the machine. The warranty does not cover such damage.
- Before switching on the machine, check that the transport brackets have been removed.
- Don't place the appliance in a room where the temperature may fall below 0°C, this could cause parts of the machine to freeze and become damaged.

- The appliance should stand firmly and horizontally on a solid base; this will avoid any excessive vibrations. Ensure the washing machine is level.
- Always consider the instructions for correct placing and installation of the machine to the mains and water supply. This will help you avoid accidents and protect your machine against damage.
- The appliance is to be connected to the water mains using new hose-sets and that old hose-sets should not be reused.
- **The appliance may not be built-in under the kitchen worktop in a row of cabinets, because the use of the appliance without the top cover is not allowed for safety reasons. Likewise, the removal of the rear panel and the bottom of the appliance are also not allowed.**
- The appliance should be positioned in such way to provide normal ventilation.
- The outlet hose should not be immersed in the discharge water (the machine may pump the discharge water back into the machine).
- During the washing cycle, the door of the machine cannot be opened. It can only be opened 2 minutes after washing is finished.
- The glass door can become very hot during washing, as such children should be supervised whilst the machine is operating.
- Use only washing agents designed specifically for machine washing.
- We do not take any responsibility for damage caused to the gasket and other plastic parts by the improper use of bleaching or colouring agents.
- Never use washing agents containing solvents - individual component parts may be damaged or toxic gases may

be produced. There is also a risk of ignition or explosion.

- When washing is completed, remember to turn the taps off.
- Your washing machine can only be transported with transport rods. It is usually enough to use only one of the rods, that is the upper one. It is easier to insert the rod if you remove the top cover.
- Before doing anything, however, don't forget to disconnect the machine from the power supply.
- When the washing machine is installed on a carpeted floor ventilating openings must not be obstructed by carpeting.
- The rating plate with general data on the machine is situated on the back of the machine.

The appliance is not intended for use by young children or infirm persons without supervision. Young children should be supervised to ensure they do not play with the appliance.

2. Removing the Transport Rods

The washing assembly is secured with two metal rods which protect the machine during transport (fig.1).

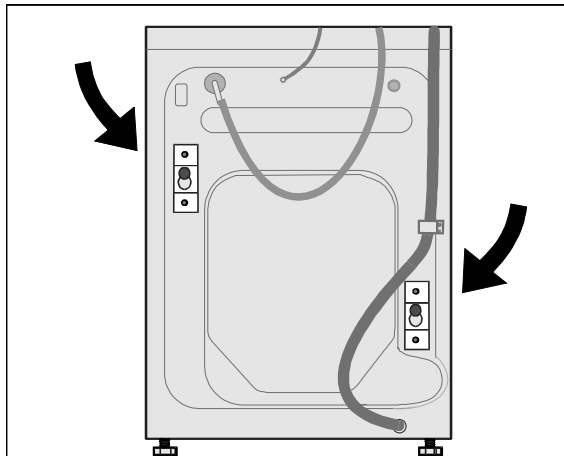

fig. 1

- Undo the screws on the rear of the machine (fig. 2).

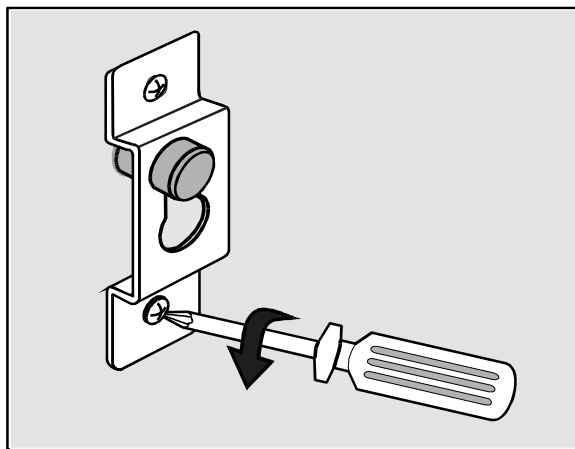

fig 2

- Remove the brackets, turn them over and use them to pull the rods out (fig. 3).

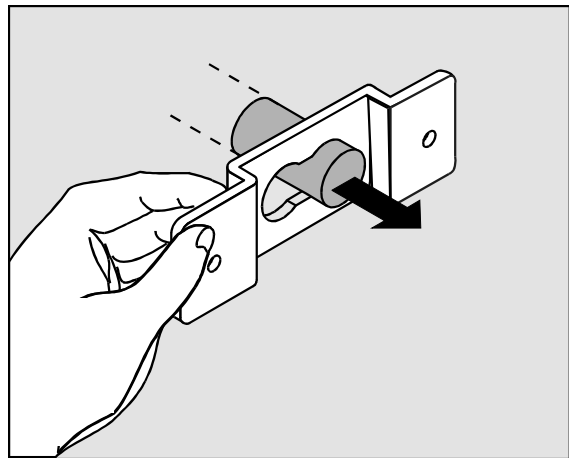

fig. 3

- Disengaged parts may remain at the bottom since they do not obstruct the operation of the machine (4 rubber hoses and 4 paper spools).
- Use the enclosed plastic caps to plug the holes (fig. 4).

There is no need to pick them up, if you have a model with sound insulation and closed bottom. The items will fall on the bottom of the washing machine and will not effect the operation of the machine.

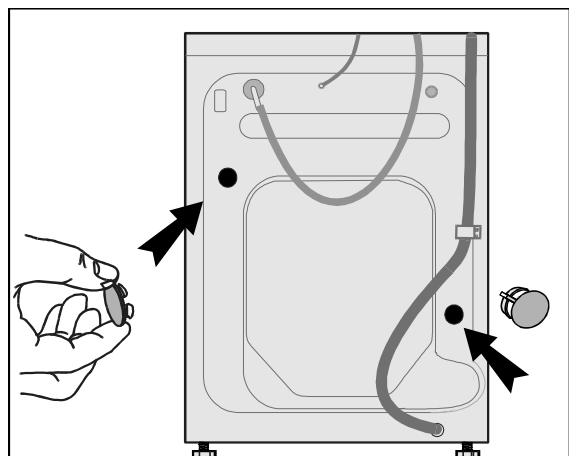

fig. 4

Save the rods as you may need them if you wish to move your washing machine.

3. Placing and Installation

If the floor is uneven, use the adjustable feet to level the machine.

- Undo the locking nuts (fig. 1).
- Rotate the feet to level the machine (fig. 2).
- Tighten the locking nuts (fig. 3).

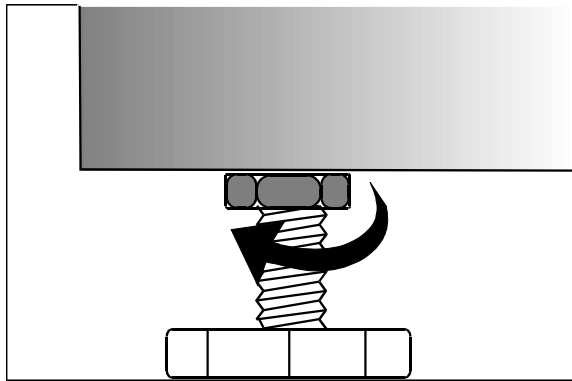

fig. 1

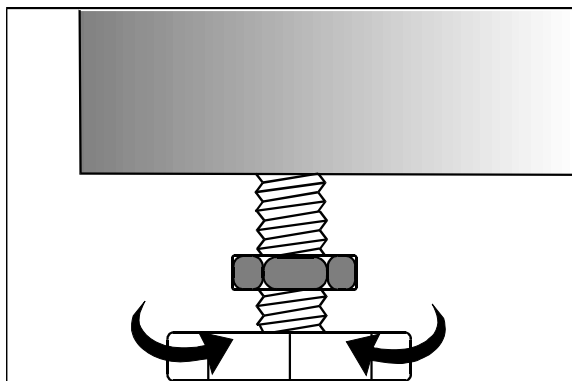

fig. 2

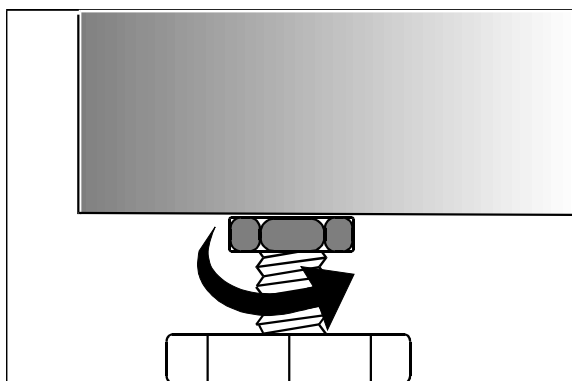

fig. 3

Maximum height of the washing machine is 850 mm.

IMPORTANT!

The machine must be steady and level on the legs, and *must not rock*. The floor on which the machine stands should be firm and dry, otherwise the machine may slide during the spinning cycle.

Connection to the Water Supply

The elbow connection of the inlet hose is fixed to the coupling on the rear of the washing machine.

Insert a strainer (mesh) washer into the nut at the other end of the hose and fix the hose to a tap. To ensure efficient operation, the water pressure of the water supply should be **(min. 7 and max. 115) psi**.

If the pressure exceeds the maximum limit allowed, fit a pressure regulator (available at plumbing supply outlets). Open the tap fully - in 15 seconds, 3 litres of water should pour out; this is the **minimum** pressure of the water supply.

Connection to hot/cold

Washing machines designed for the connection to hot/cold water are equipped with two inlet hoses.

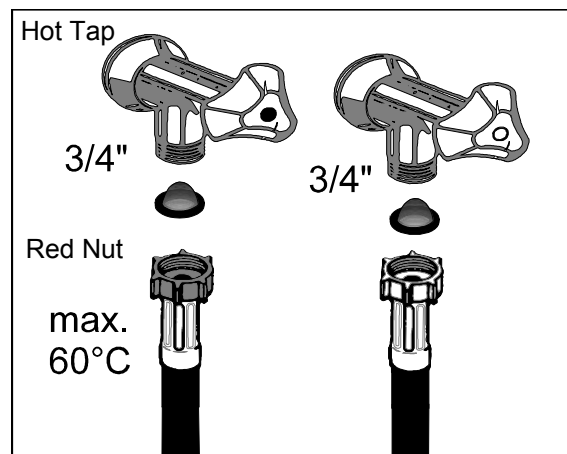

The attachment and the inlet hose for hot water are marked with red colour. Insert the enclosed washers with the filter into the loose ends of the hoses and connect the red marked hose to hot water tap and the other hose to cold water tap.

IMPORTANT

The highest allowed temperature of hot water is 60°C. If your water supply is hotter than the required temperature, you must fit a tempering valve, available from plumbing supply outlets. High water temperatures may damage the inlet hoses and valves, which is not covered by warranty.

Water Outlet

Hook the outlet hose securely over the edge of the washbasin or tub. The outlet hose can also be connected directly to a standpipe, the diameter of which should be not less than 4 cm. Wall siphon drain must be correctly fitted in such manner to enable cleaning.

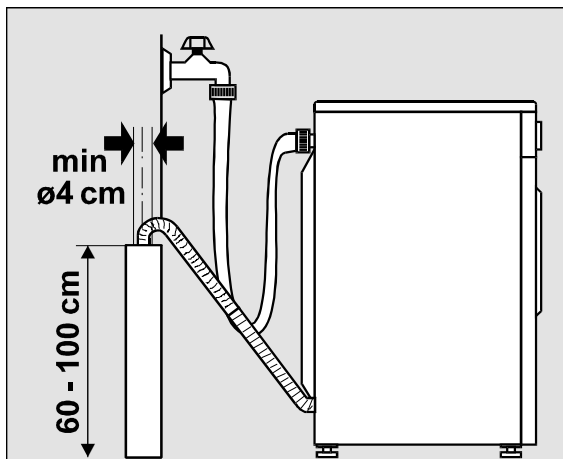

If the water is drained through a small washbasin, always check it is drained quickly enough, otherwise an overflow may occur or the machine may pump the water back. To secure the outlet hose to prevent movement, tie a string through the hole on the plastic elbow.

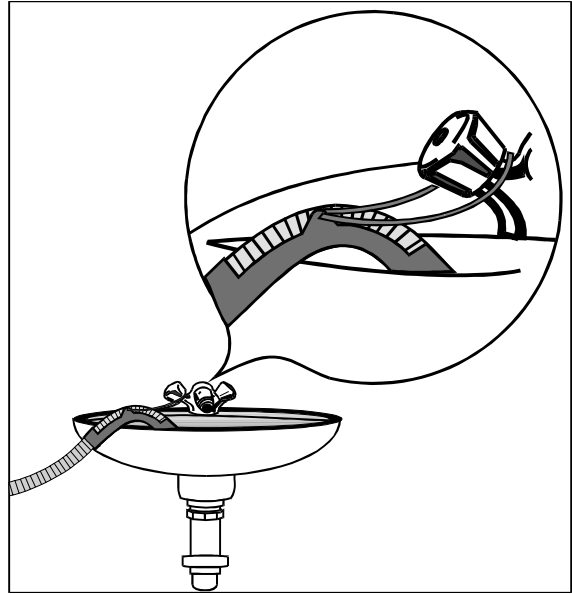

The end of the outlet hose should be raised from the floor by not more than 100 cm and not less than 60 cm. If the hose is positioned higher than recommended, the machine will not pump out the water and if lower, it may syphon the water out.

Connection to Power Supply

Connect the appliance to the power supply with the cord provided. A three pin, switched, earthed power point less than 1500 mm from the back of the machine is required. Rated voltage, frequency and other data are listed on the rating plate on the back of the machine. Check that the supplied electrical voltage is the same as on the rating sticker.

Your washing machine should be earthed and connected to the power supply according to local electricity supplier regulations and standards.

If the supply cord of this appliance is damaged, it must be replaced by the special cord, part no. G 360440, available from your nearest spare parts centre (refer to guarantee and service guide).

4. The Door

The door can only be opened two minutes after the washing programme has finished. This is a safety feature to ensure that the wash bowl has finished spinning. Open the door by pulling the door handle (fig. 1).

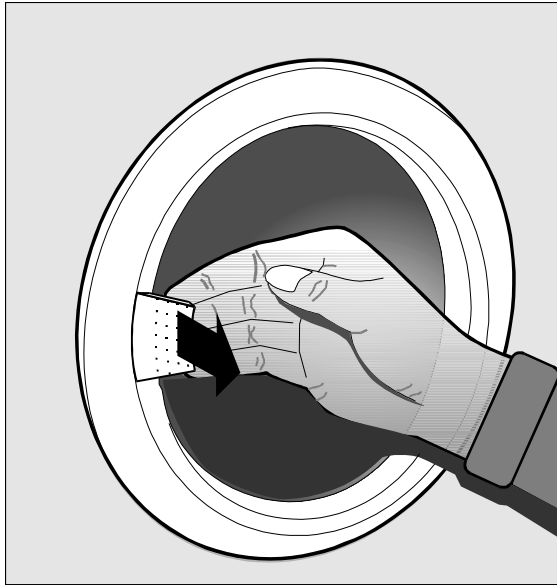

fig.1

When closing the door, push it towards the machine until it locks (fig. 2). If the door is not correctly closed, the machine will not operate.

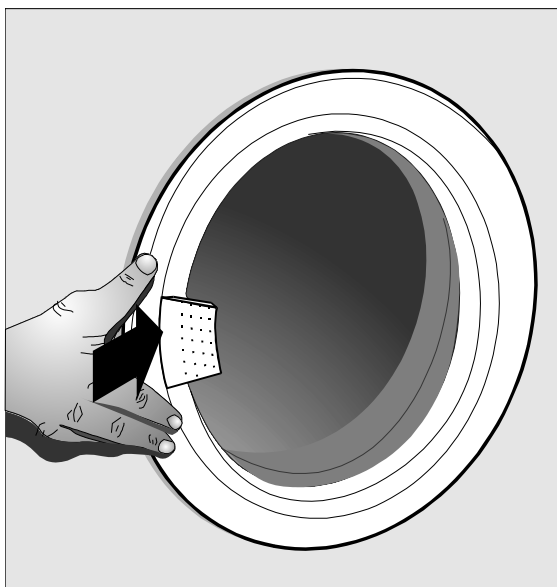

fig.2

IMPORTANT

- When closing the door, be careful not to trap fabric between the door glass and the rubber gasket.
- Do not try to open the door while the machine is in operation. If you need to open the door after the machine has been switched on, first switch it off and wait for about two minutes.
- When opening the door, be careful, as the water level may be high and water may pour out when you open the door.
- If the machine won't start after switching it on, push the door once again towards the machine (using the handle).
- An incorrectly closed door is the most common cause of malfunctions.

Direction of Opening the Door

Certain models of appliances allow the possibility of changing the direction of door opening. This is an option that has to be ordered separately and paid for by the customer.

5.Preparing the clothes

Sort the clothes before washing according to type, quality, colour and the level of soiling of the laundry.

Types of Fabrics

The labels found on clothing can be of assistance when determining the washing temperature, and wash programme to use.

Put delicate laundry (eg. pantyhose, fine underwear) into a sack or pillow case if they are to be washed together with other laundry.

Colour Fastness

When washing new clothes, always check colour fastness first - wash separately the first time.

Pay special attention to colour fastness, and always choose the correct washing temperature.

Degree of Soil

Stained and heavily soiled laundry should be washed in small loads or with a larger amount of washing powder. Heavily stained or soiled areas on the fabric can be treated before washing with special agents.

Use the energy saving programme B for lightly soiled laundry (no pre-wash, economic programme, lower washing temperature).

Loading

The maximum load of dry laundry is stated in the tables (page 14-15). Excessive loads cause creases and decrease the washing effect. Always check the pockets before loading the laundry.

Remove keys, coins, hair-pins and similar objects that may block the water outlet hose or drain pump.

Zip the zippers and remove metal pins that may damage the laundry or even the wash bowl. Folded clothes should be loosened before loading.

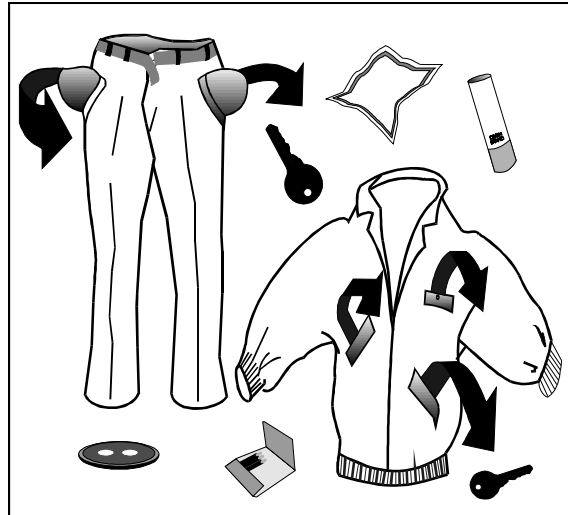

The best washing effect is obtained by mixing larger and smaller items of laundry in one load.

6. Washing Agents and how much to use

Use only washing detergents designed for machine washing. *Do not use soap flakes.*

Use special washing detergents for delicate and woollen fabrics.

This washing machine was designed for washing powder as well as for liquid detergent. As to the quantity of the detergent, refer to the manufacturer's recommendation. The quantity of detergent recommended is usually sufficient for 4.5 to 5 kg of normally soiled laundry, depending on the hardness of the water.

If your water is hard we recommend using water softener. This means that you can then use the same quantity of washing powder as if the water was soft.

Dispenser

The detergent dispenser is divided into three compartments (fig.). The Table of Washing Programmes (page 14-15) shows which compartments to use.



Compartment I: This compartment is only used for washing powder when a programme has Prewash.



Compartment II: This compartment is used for washing powder on all programmes.



Compartment III: This compartment is used for fabric conditioner and starching agent.

Always add washing agents before switching the machine on and keep the dispenser clean and dry, so that the washing agent can be efficiently dispensed from the unit.

With programmes without a pre-wash cycle, the washing powder can be put directly in the drum. This is convenient if:

- you use larger amounts of washing powder (very hard water),
- you use washing powder which is hard to rinse from the dispenser,
- water pressure is low.

Not enough washing powder causes:

- the laundry to turn grey,
- greasy cloths.

Too much washing powder causes:

- sudsing,
- reduced agitation and washing effect,
- inadequate rinsing.

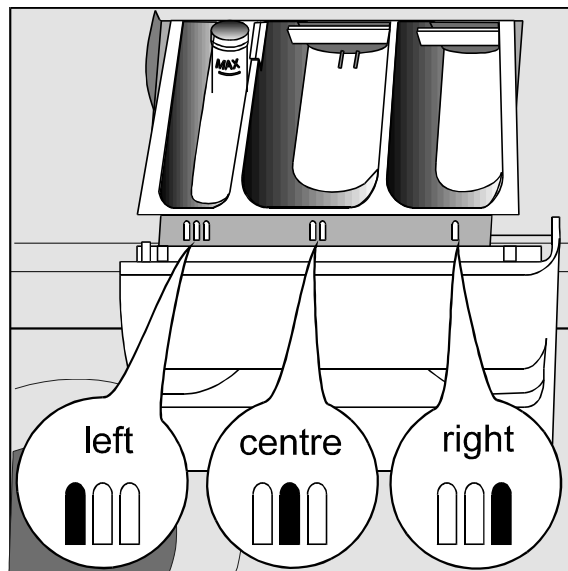

***NOTE:** The dispenser has three compartments marked "I", "II" & "III". "I" and "II" (the centre and right compartments) are for detergent. The wash programme guide on the control panel shows where detergent can be added. The left compartment "III" is for conditioner only.

Fabric Conditioner

When using fabric conditioner, always follow the manufacturer's instructions, but never fill higher than the level

marked on the dispenser. The excess is immediately poured out before washing and is therefore pure waste. When using high density liquid conditioners we recommend mixing it with water before filling, otherwise the dispenser outlet may clog. The dispenser should be washed if the dispenser is clogged and the liquid is not flushed. Be sure to remove the level indicator and wash the conditioner dispenser with a brush and lukewarm water (or rinse under the tap).



***NOTE:** Compartment “III” on the left is the only compartment where conditioner should be used.

Liquid Detergents

If the washing machine is equipped with a partition plate, the middle section may also be used for liquid detergents. Lift the partition plate when using a powder and push it in when using a liquid. (Fig. 13). We recommend using a liquid detergent in non-pre-wash programmes.

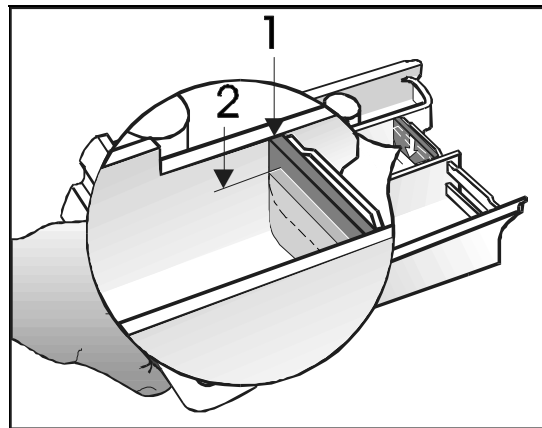

7. Washing Machine Control Panel

Before washing, load the clothes, detergent and conditioner, then select the washing programme.

The control panel incorporates various switches and pushbuttons for selecting washing programmes, a control light, and a dispenser.

Control Light

Control light is lit when the machine is switched on.

Programme Selection Knob

A-M This knob is used to select washing programmes. Don't forget, when turning the knob, the machine should be switched off.

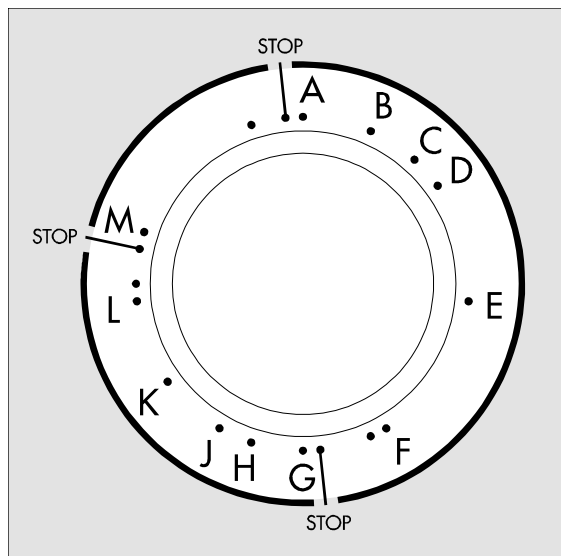

Washing programmes are marked on the knob from **A** to **M** and are divided into three groups.

Programmes for non-delicates (A-F)

Programmes are intensive and finish with 6-minutes spin cycle.

Programmes for delicates (G-L)



Programmes with gentle tumbling and are finished with short spin cycle (2 minutes).

Programme for Woollens (M)







































Programme for woollens may as well be used for washing delicates and specials. Laundry is washed with higher water level and gentle tumbling. The programme is finished with 2 minutes spin cycle.









ON/OFF Pushbutton

-  **ON** Select the desired washing programme.
-  **OFF** Prepare the laundry for washing and press the ON/OFF switch to switch the machine on.



8. Table of Washing Programmes - KFL 806

Programme		Washing temperature (°C)	Dispenser-washing agents			Dry laundry (kg)
A ⋮ M	Type of fabric, laundry					
NON-DELICATES (cotton, linen)						
A	Whites Hot -Prewash	60				5.0
B	Whites Hot	60				
C	Coloureds -Warm	40				
D		-Cold	❄			
E	Rinses					
F	Softening					
DELICATES (surface finished cotton, mixture of cotton with synthetics, permanent press)						
G	Delicates Warm -Prewash	40				2.5
H	Delicates Warm	40				
J	Delicates Cold	❄				1.5
K	Rinses					2.5
L	Softening, Spin					
WOOLLENS (non-shrinkable, mixtures of wool with synthetics, silk)						
M	Woollens	❄				1.0

Dispenser Drawer Guide: ❄ = cold

 right:  prewash
 centre:  main wash
 left:  fabric conditioner

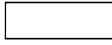
Water Temperature:

 cold
 warm
 hot

Washing time (min)	No. of Rinses	Spin: Max. rpm
152	4	800
130	4	800
92	4	800
68	4	800
40	4	800
13	1	800
70	3	800
52	3	800
40	3	800
24	3	800
9	1	800
52	3	800

9. Prepare your machine for washing

- Separate clothes and load a suitable amount -refer - Tables of Washing Programmes (pages 14-15).
- Close the door (push it towards the machine).
- Check the water inlet and outlet.
- Choose the right programme.
- Switch the machine on.

After Washing

- Switch off the machine (the control lamp turns off).

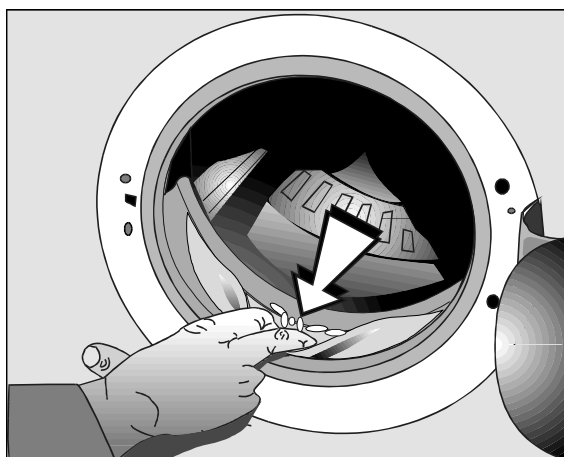

- There is a safety switch on the door. This means that you have to wait two minutes before you can open the door at the completion of the wash cycle.
- Take the laundry out of the machine and turn the drum once or twice with your hand to make sure it is really empty.
- Check the rubber gasket on the door and remove objects that may have deposited (buttons, pins etc.)
- Leave the door open and allow the interior to dry
- Turn off the taps.
- Check the dispenser and clean it if necessary and dry it well.
- Every now and then, clean and check the pump guard (refer page 21).

10. Stain Removal Guide

It is easier to treat stains if you treat them promptly:

- Try simple methods first.
- Avoid the use of the water.
- Use light strokes - **DO NOT** rub stain remover into the stain.
- Chlorine bleach should be diluted according to instructions on the pack.
- Test coloured fabrics for colourfastness.
- Test synthetics on an inside seam before any chemicals are applied.

NOTE: Some of the chemicals referred to below are available only from chemists.

White Cotton and Linens
<p>1. CANDLE WAX Scrape off excess, place stain between clean white blotter or several layers of facial tissue. Sponge with dry cleaning fluid, if spot remains, bleach.</p>
<p>2. COFFEE, TEA (with milk or cream) Rinse or soak in cold water. Work detergent into stain. Thoroughly rinse and dry. If a stain remains, sponge with a dry cleaning fluid. If stain remains, bleach.</p>
<p>3. COFFEE, TEA (black) FRUIT JUICE, WINE Pour boiling water through stain. Bleach if necessary.</p>
<p>4. FAT, GREASE, OIL Sponge with safe home dry cleaning fluid (White Spirits)</p>
<p>5. GRASS, GREEN VEGETABLES Sponge with methylated spirit. Wash in warm suds.</p>
<p>6. BLOOD, MEAT JUICE, EGG (fresh stain) Rinse in cold water, if stain remains sprinkle with meat tenderiser (MSG). Let stand 15 to 20 minutes. If stain still remains, then sponge with diluted bleach. Launder in hot water.</p>
<p>7. BLOOD, MEAT JUICE, EGG (dry stain) Cover area with meat tenderiser (MSG). Apply warm water to make a paste. Wait 15-30 minutes. Sponge with cool water or with diluted bleach.</p>
<p>8. ICE CREAM, CREAM, MILK Rinse or soak in cold water and launder. If ice cream contains fruit or chocolate treat stains as such.</p>
<p>9. CHOCOLATE Soak in warm water with pre-soak product and wash in lukewarm water. Use solvent to remove any grease spots</p>

Washable Coloured Fabrics
<p>1. Same method - use oxygen type bleach.</p>
<p>2. Same method - use oxygen type bleach.</p>
<p>3. Soak or rinse in cold water or sponge with warm water and detergent. Use oxygen type bleach</p>
<p>4. Same as for Whites.</p>
<p>5. Same as for Whites. Check colourfastness before applying methylated spirit. For acetate, sponge with dry cleaning fluid.</p>
<p>6. Same method but select water temperature suitable to fabric. Use oxygen bleach.</p>
<p>7. Same method but select water temperature suitable to fabric. Use oxygen bleach.</p>
<p>8. Same method.</p>
<p>9. Soak in warm water with pre-soak or detergent solution. Bleach remaining stain.</p>

White Cotton and Linens
10. CHEWING GUM Rub with ice to harden. Scrape off excess with dull knife. Sponge with dry cleaning fluid.
11.FOUNTAIN PEN INK Sponge with Hypo, (Sodium Hyposulphite) rinse and apply oxalic acid.
12. BALL POINT PEN INK Sponge with methylated spirit. Bleach if necessary.
13.IODINE Wash in hot suds.
14. IRON RUST Apply oxalic acid and place in sun.
15.LIPSTICK Rub with lard and wash in hot suds. Bleach if necessary.
16.SCORCH Moisten and place in sunlight. Bleach if necessary.
17. MILDEW Wash in hot suds. Moisten with lemon juice and let dry in sun. If stain persists, bleach. Old stains are hard to remove.
18.MUSTARD Wash in hot suds and bleach.
19. PAINT (oil based) Scrape off fresh paint. Soften dry paint with lard or oil, then sponge with turpentine (turps).
20. NAIL POLISH Sponge with acetone, dry cleaning fluid or nail polish remover. Bleach to remove dye.
21. FRUIT Sponge with warm water and wash. Bleach remaining stain with oxygen bleach.

Washable Coloured Fabrics
10. Same method.
11. Sponge with methylated spirit then lemon juice.
12. Same as for whites but omit bleach.
13. Wash in warm suds.
14. Apply lemon juice and place in sun.
15. Rub with lard and wash in warm suds.
16. Usually a permanent stain. Brush wools tightly with sandpaper.
17. Same method but select water temperature suitable to fabric.
18. Same method but use water temperature to suit fabric.
19. Same as for whites.
20. Sponge with dry cleaning remover.
21. Pour boiling water through stain. Bleach remaining stain.

11. Cleaning and Maintenance

Cabinet, Cabinet control and Top Panel

Clean the outside of your washing machine with a soft cloth and mild detergent. Do not use coarse cleaning agents which could damage the surface.

Drum Interior

As a result of inadequate washing, greasy clots may appear on the drum rubber, door gasket or even on the laundry. Remove them as follows: Prepare a solution of 3/4 - 1 kg of washing soda (calcified soda) and 1 litre of cold water. Pour the solution through the dispenser, set the control knob to programme B and set temperature to 95°C (where fitted). When this programme is finished, your washing machine is ready for use.

Dispenser

Inspect the dispenser after each wash. If there is a residue of washing powder, clean it. Pull it out of the machine, clean it with a brush and warm water, and dry it.

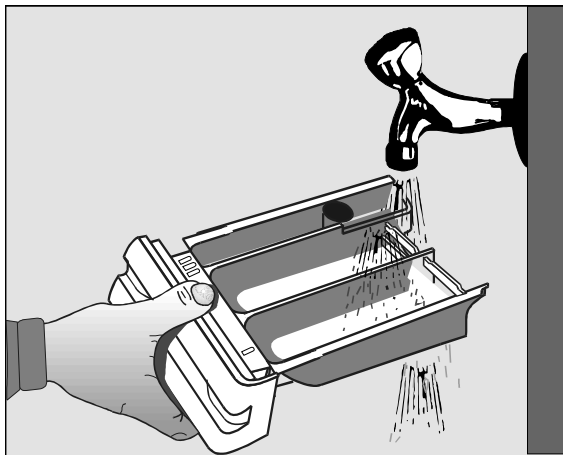

If necessary clean the interior of the detergent dispenser casing, in case you detect the remainings of washing powder inside.

Wire Net in the Inlet Hose

The wire net in the inlet hose should be frequently cleaned.

Turn off the tap and remove the inlet hose. Clean the net under a tap, replace it and fix the inlet hose.

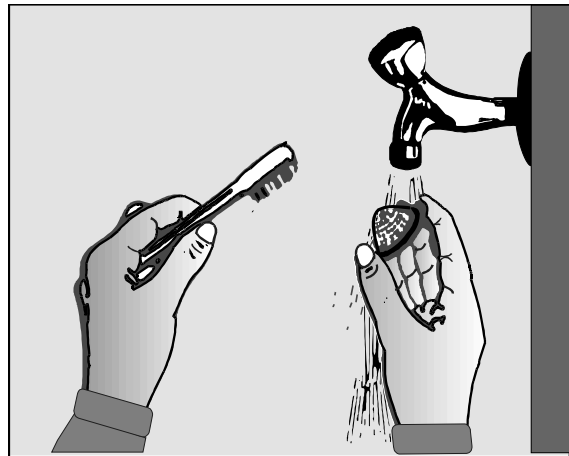

Door Gasket

Wipe the rubber door gasket after each wash; the gasket will last much longer.

12. Trouble-Shooting Guide

During operation, malfunctions may occur that can be easily eliminated.

For more serious defects please phone your nearest service centre.

1. The machine doesn't operate (the control lamp is off).

Check the power supply and fuses.
Is the plug correctly placed in the socket.

2. Water is not pumped into the machine.

Is the machine switched on?
Are the taps turned on?
Is the wire-net filter on the inlet hose clean?
Is the door closed?

3. The machine jumps during operation.

Are the transport rods removed?
Is the machine correctly levelled? (if not, use the adjustable legs).
Check the load (perhaps you are washing only one large item).

4. The machine is leaking.

Is the pump guard properly fixed?
Is the inlet hose properly secured to the tap and to the machine?

5. The wash load is too wet.

Is the pump guard clean (free of solid particles)?
Check whether the wall siphon drain is clogged (clean it).

6. Too much bubbling during washing.

Check the water hardness and reduce the quantity of washing powder you are using.

7. Washing was not efficient (stains, greasy clots).

Have you chosen the correct wash programme? Use larger quantities of washing powder for heavily soiled laundry, or wash smaller loads.

8. Laundry is not well rinsed (wash powder residue).

Is the pump guard clean (free of solid particles)?
Perhaps you overloaded the machine (especially delicate fabrics) and used too much washing powder.
Check whether the wall siphon drain is clogged (clean it).

9. The appliance fails to reach washing temperature at short programs (D,J,M)

Check if the voltage is correct
Check if the inlet water is too cold
Check if the "high water level" button is on

WARRANTY AND SERVICE

DOMESTIC WARRANTY - FULL FIVE YEAR WARRANTY

In addition to all statutory rights which you, the Consumer, have under the relevant laws in respect of this appliance, during the first five years of ownership as the original purchaser of this Kleenmaid appliance, we guarantee that any fault caused by faulty material or workmanship becoming apparent will be rectified free of charge for parts and labour, provided that all service is performed during normal working hours by Kleenmaid or their designated Agents. Where the appliance is installed outside the normal servicing area of the above, the Purchaser must pay for the cost of transporting the appliance to and from the Agent or the Agent's travelling cost to and from the Purchaser's home.

COMMERCIAL WARRANTY - ONE YEAR WARRANTY

When this appliance is installed in a commercial application, you, the Consumer, have under the relevant laws in respect of this appliance, during your first one year of ownership as the original purchaser of this Kleenmaid appliance, we guarantee that any fault caused by faulty material or workmanship becoming apparent, will be rectified free of charge for parts and labour, provided that all service is performed during normal working hours by Kleenmaid or their designated Agents. Where the appliance is installed outside the normal servicing area of the above, the Purchaser must pay for the cost of transporting the appliance to and from the Agent or the Agent's travelling cost to and from the Purchaser's home.

WHAT THESE WARRANTIES DO NOT COVER

We are not responsible for any damage or malfunction unless caused by a defect in material or workmanship. This includes but is not limited to abuse, misuse, improper installation and transportation damage. We are not responsible for any consequential damages from any malfunction. The Consumer must make the appliance available for servicing and shall bear any costs incurred for any de-installation and/or re-installation required to make the appliance available for servicing. Kleenmaid is not liable for any consequential damage incurred during de-installation or re-installation.

WARRANTY DOES NOT COVER REPLACEMENT OF LIGHT GLOBES OR GLASS BREAKAGE DUE TO IMPACT

In case of fractured glass do not use your appliance.

WARRANTY REGISTRATION

Please complete warranty details below. Please retain together with your proof of purchase document. These documents will need to be viewed by our Service Representative should you request in warranty service.

SERVICE ASSISTANCE

To assist you when phoning our After Sales Service number to arrange a service call please complete the following details and have them ready when you call.

Model Number _____ Date of purchase _____

Kleenmaid Store purchased from _____ Date of installation _____

KLEENMAID AFTER SALES SERVICE
1300 652 100

