

## ELECTRICAL CONNECTION

# Owner's Manual

*Any electrical wiring must be carried out in compliance with the local electricity board regulations by a qualified electrician.*

**WARNING: ALL APPLIANCE MUST BE EARTHED**

*Our company cannot accept responsibility for any damage to persons or property arising from faulty connection or non connection to earth.*

*Before connection or installing the hob electricity supply must be switched off.*

# TO20

## INDEX

Welcome to Kleenmaid and to the superior cooking efficiency of your new Scala

Standard Static oven	1
Control Panel	2
Functions oven	3
Installing scala ovens	4
Changing the oven light bulb	5
Removing the oven door	5
Cleaning the oven	6
Self-cleaning panels	6
Baking chart	7
Full five years warranty	8

## STANDARD STATIC OVEN



Model T0 20

## GENERAL DATA

### Dimensions of the Oven

Height: 598 mm.  
Widh: 598 mm.  
Depth: 520 mm.  
(Overall depth is 542 mm. Including 22 mm. Fascia trim)

### Cut-out cabinetry dimensions

Height: 570 mm.  
Widh: 562 mm.  
Depth: 25 mm.

### Electrical Data

240 V, 50 Hz, 11 A Approval No. W2263

### Accessories Supplied

1 x enamelled pan with rack, 2 x racks with baking trays

### Cooking Volume

52 litres

## CONTROL PANEL

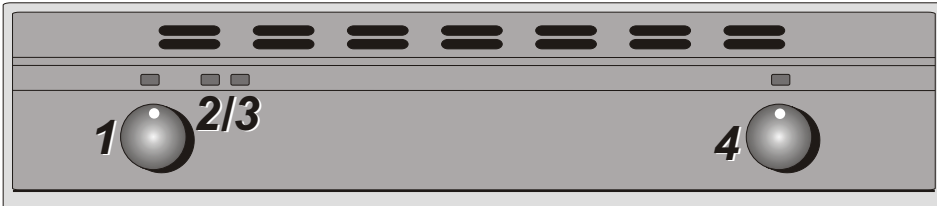

Provides for various cooking options

**2. Yellow indicator light** - indicates elements are energised - will turn off when temperature is reached, then on again each time the thermostat indicates more heat is needed.

**3. Red indicator light** - indicates a function has been selected

**4. Clock** -  
Allows normal count down timer

## SELF-CLEANING PANELS

Self Cleaning Panels (PIN SPA 2) may be purchased as an optional extra for the multi-function oven. Refer to Page 6 for details.

## SERVICING

**IMPORTANT:** Electrical connections must only be performed by a licensed electrical contractor. For service and repairs, contact your local Kleenmaid retailer, or a Kleenmaid State office - see BACK PAGE for details.

## INSTALLATION

For installation details, see instructions on Page 4.

## FUNCTION- OVEN

Using the **OVEN FUNCTION SELECTR KNOB**, the following functions are available:

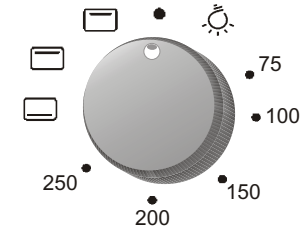

 **NORMAL OVEN** - traditional cooking with top and bottom element. Select temperature required on thermostat. When temperature is reached the yellow light will go out and then begin to alternate between lit and unlit as the temperature is controlled.

 Allows full power **BOTTOM ELEMENT ONLY**

 Allows full power **TOP ELEMENT ONLY**

 **FULL GRILLING** (open door and place grill deflector in place).

## USE OF MINUTE MINDER

To use the minute minder turn the knob clockwise to the chosen position. A ringing buzzer will advise when the time has elapsed.

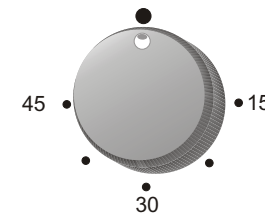

## INSTALLING SCALA OVENS

**IMPORTANT: Connection to electrical mains must only be performed by a licensed electrical contractor.** All care must be taken to ensure the installation is properly earthed and conforms to all local codes.

Refer to GENERAL DATA (page 1 or page 4) for details of the particular cut-out and depth dimensions required for the model oven installing. Prepare the cut-out in the cabinet and ensure that side sliders are available to allow the underside of the oven to be supported whilst allowing the unit to slide in.

Use the 4 screws provided to secure the front trim side rails to the cabinet front.

Scala ovens may be installed in any type of heat resistant cabinet (eg, timber finished in plastic laminate, timber, metal, brickwork, etc), either as a wall unit or under a work bench.

If installed as a wall unit, ensure that the upper-rear section of the cabinet has an 80-90 mm depth vent. When installed under a bench, the oven must be a minimum 25mm above the floor, and there must be a minimum 50mm from the top of the unit to the underside of the bench top. In addition, a 80-90 mm wide vent must be provided in the kitchen cabinet floor so that hot air which accumulates around the top of the oven is drawn away and replaced by cool air coming in from underneath the oven.

**NOTE:** any vertical, cupboard panels immediately beside the wall oven must be sealed completely to obtain the best result from your oven.

**IMPORTANT:** So that your Scala oven maintains its efficient sealing capacity for the life of the appliance, **NEVER USE THE DOOR AS A LEVER** (especially when the oven is being installed into its recess). Similarly, undue pressure must never be placed on the oven door when it is open.

## FREE IN-HOME DEMONSTRATION

Please contact our Customer Call Centre on 1 800 072 144 to arrange for your Free In-Home Demonstration.

Our trained Demonstrator will make an appointment to visit you in your home and explain how to confidently use and care for your cooktop.

Please note that we may not have a Kleenmaid Demonstrator in some regional areas. In this case we will organise a step-by-step telephone demonstration to ensure you are able to achieve the best result from your cooktop.

## CHANGING THE OVEN LIGHT BULB

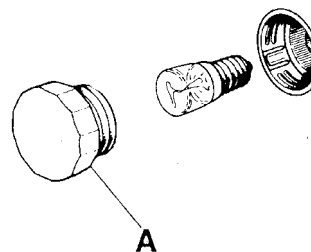

1. (See diagram above). Remove cover (A) by unscrewing in an anticlockwise direction.
2. Replace bulb (15WES)
3. Remount cover (A)

## REMOVING THE OVEN DOOR

(See diagrams, below)

Removing the door allows easy access to the interior of the oven for cleaning. To do so:-

1. At either side of the door, the Hinges (A) have two clips (B) which can be moved. Normally these remain flat against Hinges (A). Open the door fully and hook the clips (B) to Part © of the Hinges. The door assembly can now be removed.
2. Lift the door towards the outside (see the illustration at right, below; two movements, ie, up-and-towards-yourself, gripping the door near each hinge).
3. To replace the door, firstly insert the hinges completely into the grooves.
4. Unclip the two clips (B) which hold the two hinges - **THIS IS IMPORTANT!** The door is now in place.

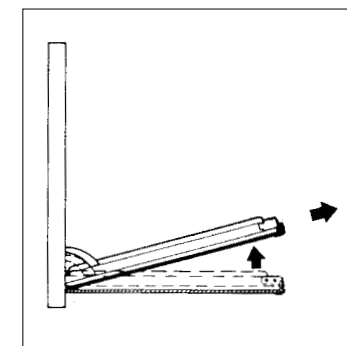
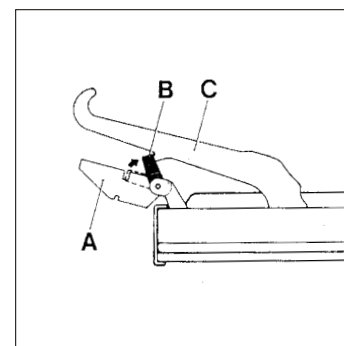

## CLEANING THE OVEN

To obtain maximum efficiency from your oven, it should be cleaned regularly. It is best to deal promptly with stains caused by spills during cooking. This can be most easily achieved with a moist sponge whilst the oven is STILL WARM. (Take care not to burn yourself, however).

Use warm water and liquid detergent to clean the enamel and decorative control panel, door, etc. Dry with a soft cloth. NEVER use abrasive powder or acid/chlorine based cleaners.

Always avoid cleaning the glass until COLD. The inner glass can be easily removed when necessary by unscrewing the 2 locating screws with a coin. Be careful to re-position the door gasket accurately when reassembling after cleaning.

## SELF - CLEANING PANELS

Self Cleaning Panels (**PINSPA 2**) may be purchased as an optional extra for the fan oven cavity. They are attached to the sides by removing the rack guides assembly and placing the self cleaning panels against the oven side walls and to the back is attached to the pins. Ensure that the «rough» side is facing out. These liners are «self cleaning» during the oven's heat cycle.

If residue remains on them after cooking, empty the oven of food, and turn the selector to Static Coking and thermostat to MAX; 15-20 minutes should be adequate to clean the panels using this method.

### How the Self Cleaning Panels Work.

The Scala self-cleaning oven panels go through a special enamelling process which ultimately creates a rough surface (this is the side which should face outwards in the oven).

Because of the structure of the surface, it is extremely porous and attracts oxygen. When the stain hits this surface it immediately spreads outwards.

In this way, immediate oxidisation of the stain occurs, and it ultimately disappears while the oven is in general use at standard cooking temperatures. The self cleaning panels are located on the sides and on the back of the oven, and are designed to cope with fatty stains very efficiently. For stains on the bottom of the oven, the usual causes are sugar or starch overflows.

**BEWARE: Never use silicone films (polished or cleaners) on self-cleaning panels - they will be rendered useless. Similarly, NEVER try to wash with detergent, or use abrasive cleaners on the panels.**

## BAKING CHART

\*Shelf positions are numbered from the top, down.

		NORMAL BAKE SHELF*	TEMP ° C	Time
<b>BAKED PRODUCTS</b>				
Bread	loaves	2,3	170-190	10-20mins
	Rolls	3	210-220	30-45mins
Cakes	butter	3	200-210	15-20mins
	Patty	3	180	45-60mins
	Rich fruit	3,4	180	15-20mins
	Sponge	3	150-160	1.5-2hrs
Meringues		3	180-190	15-25mins
Muffins		3	100-110	1.25-1.5hrs
Pastry	short	2,3	200-220	15-20mins
	Flaky	2,3	200	10-15mins
	Puff	3	230	10-20mins
	Choux	3	230-250	10-20mins
			230/190-	40-60mins
<b>CASSEROLES</b>				
Beef, Veal		3,4	160	2.25-3hrs
Lamb, Mutton, Pork		3,4	160	1.75-2.25hrs
2.25hrs				
Poultry		3,4	170	1-1.25hrs
<b>DESSERTS</b>				
Baked cake type		3	180-200	20-30mins
Baked custard		3	180	35-45mins
Baked fruit		2,3	200	50-60mins
Fruit crumbless		2,3	180	20-40mins
Meringue toppings		3	180-200	15-20mins
Pavlova		3	150/100	2-2.5hrs
<b>FISH</b>				
whole		2,3	180	25-50mins
Fillets		2,3	180	15-30mins
<b>POULTRY</b>				
Chicken	pieces	2,3	180	30-45mins
	Whole	3	160-170	25-30mins
Turkey		3,4	150	15-20mins
<b>SUOFFLES</b>				
Large		3	180	45-55mins
Individual		3	180	35-50mins
<b>VEGETABLES</b>				
Baked potatoes		2,3,4	200	45-60mins
Oven cooked rice		2,3	180	40mins
Oven seamed		2,3	180-190	35-45mins
Roast		2,3,4	160-180	1-1.5hrs

# FIVE YEAR WARRANTY

## ***Domestic Warranty - Full Five Year Warranty***

*In addition to all statutory rights which you, the Consumer, have under all the relevant laws in respect of this appliance, during the first five years ownership as the purchaser of the Kleenmaid appliance, we guarantee that any fault caused by faulty material or workmanship becoming apparent, will be rectified free of charge for parts and labour, provided that all service is performed during normal working hours by Kleenmaid or their designated Agents. Where the appliance is installed outside the normal servicing area of the above, the Purchaser must pay the cost of transporting the appliance to and from the Agent or the Agent's travelling cost to and from the Purchaser's home.*

## ***Commercial Warranty - One Year Warranty***

*When this appliance is installed in a commercial application, you, the Consumer, have under all the relevant laws in respect of this appliance, during your first one year of ownership as the purchaser of the Kleenmaid appliance, we guarantee that any fault caused by faulty material or workmanship becoming apparent, will be rectified free of charge for parts or labour, provided that all service is performed during normal working hours by Kleenmaid or their designated Agents. Where the appliance is installed outside the normal servicing area of the above, the Purchaser must pay the cost of transporting the appliance to and from the Agent or the Agent's travelling cost to and from the Purchaser's home.*

## ***What This Warranty Does Not Cover***

*We are not responsible for any damage or malfunction unless caused by a defect in material or workmanship. This includes, but is not limited to abuse, misuse, improper installation and transportation damage. We are not responsible for any consequential damages resulting from any malfunction.*

## ***"Warranty Does Not Cover Replacement Of Light Globes***

### ***or Glass Breakage Due To Impact"***

*In case of fractured glass do not use your appliance*

*Please complete the enclosed warranty card and post it to us.*

## ***Service***

*To assist you when calling our Customer Call Centre number to arrange a service call, please complete the following and have these details ready when you call.*

*Model No.* \_\_\_\_\_

*Kleenmaids store purchased from* \_\_\_\_\_

*Date of purchase*      /  /      *Date of installation*      /  /  

*Should you require service, please call our National Call Centre  
on 1 800 072 144 (freecall)*