

Owner's

Manual

Multi-function Oven

<i>Model</i>	<i>T056X</i>	<i>(Stainless Steel)</i>
	<i>T056W</i>	<i>(White)</i>

 **KLEENMAID**

MANUFACTURED BY **Brandt**

F O R T H E U S E R

Using this appliance makes cooking a real pleasure!

This Owners Manual contains important information on the safety, use and what you can expect from your Kleenmaid Multifunction Oven.

We advise you to read this book carefully to get the best use of this appliance's technical qualities. To ensure that your oven remains in perfect condition, we have provided important advice for you on its care and cleaning.

I M P O R T A N T N O T E S

Caring for the environment

- As a contribution to the protection of the environment, we have used non-chlorine bleached and recycled paper for your appliance's documentation.
- Please consider the environment when disposing of the packaging from your new appliance.
- The packaging is designed not to be harmful to the environment; it can be recovered or recycled: these are environmentally friendly products. By recycling the packaging, you are contributing to a saving in the consumption of raw materials and a reduction in the volume of industrial and household waste.
- Render your old appliance unusable before disposing of it. Contact your local authority or a disposal centre about scrapping the appliance.

Connecting the appliance

- Your appliance should be installed by a specialist in accordance with the recommendations in the installation section of this instruction manual.
- The measurement instructions for building-in the oven which are given in this instruction manual must be followed precisely.
- We advise you to read the following pages very carefully to enable you to get the best from your cooking appliance.

Advice on safety

- This appliance is exclusively for domestic use.
- When cooking with fat or oil, stay close by, as these materials can catch fire if they overheat. **DO NOT STORE FLAMMABLE OBJECTS IN THE OVEN OR ON THE HEATING ZONES.**
- When plugging domestic electrical appliances into a socket nearby, make sure that the power cable is not touching the heating zones or caught in the door.
- Do not use the oven door handle to dry linen as this will prevent the oven's front ventilation from working.
- In the event of a malfunction, remove the mains fuses.

Practical advice

- To prevent a build-up of heat, which will affect cooking results and damage the enamel and the housing unit:
Do not place any utensils on the floor of the oven.
Do not line the interior of the oven with aluminium foil.
- Use the temperatures suggested in the cooking guide, to prevent excessive fat splashes in your oven.
- To protect the enamel on your oven and ensure its air-tightness:
Do not lean on the open door.
Keep the door seals clean.
- For all cooking on the grill:
Place the items to be cooked onto the shelf.
Slide the dripping pan under the shelf to collect the cooking juices and prevent splashing.
- **Cooking should always be done with the door closed.**

THE LAYOUT OF THE CONTROL PANEL

Control panel

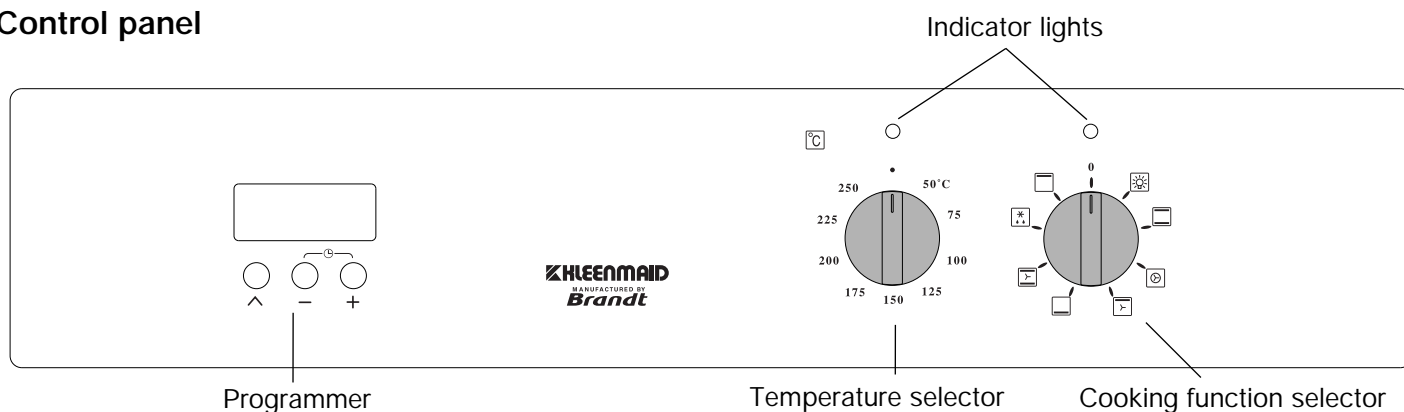

Cooking function selector

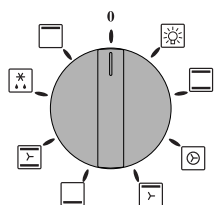

Turn the selector knob clockwise to the position corresponding to the function required (see cooking guide). The cooling fan will operate and the light will come on.

0 Off position for the oven



The oven light only



Conventional oven

This function is for conventional cooking and uses the top and bottom elements. Suggested cooking items ; casseroles, fruit cakes and souffles.



Fan forced oven :

This function is best for multi-level cooking as the heat generated by the central element circulates around the oven, creating an even heat throughout. Suggested cooking items ; small cakes, biscuits, roast meats and vegetables.



Fan assisted grilling :

This function combines the grill element with fan assistance to ensure even cooking and browning. Suggested cooking items ; chickens breast/wings, kebabs, fish and cultets. **Always grill with door closed.**



Bottom element

This function is completed mainly from the bottom oven element. Suggested cooking items : yeast dough, bread, fruit tarts and brioche.



Fan assisted :

Heat from above and below, with hot air circulated by the fan.



No heat defrost :

Fan only. The temperature selector. **MUST NOT** be used with this function.



Conventional grilling.:

Use in conjunction with temperature selector. **Grill with door closed.**
Note : it is recommended that you do not grill for longer than 30 minutes at any one time. For additional information on cooking modes turn to page 13.

THE LAYOUT OF THE CONTROL PANEL

Temperature selector

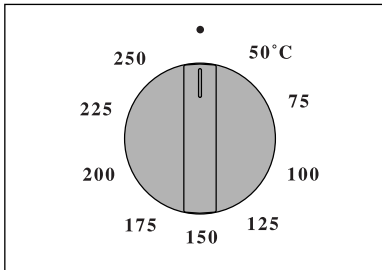

Turn the temperature knob to the right to the setting required (see cooking guide enclosed with the instruction book).

Programmer

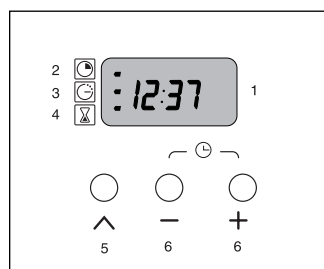

- 1 - Time (display from 0.00 to 23.59)
- 2 - Cooking time
- 3 - End of cooking time
- 4 - Timer (59 min. 30 sec.)
- 5 - Programming button
- 6 - Buttons for cooking time (+ or -)

Setting the clock

a) When the oven is first connected

- Adjust the time using the **+** and **- Buttons (6)** (keep pressing on the button to change the numbers more quickly).
Example : 12h30.
- Press the "PROGRAMMING" **Button (5)** to validate

NOTE: If the "PROGRAMMING" **Button (5)** is not pressed, the oven will automatically validate the numbers set after a few seconds.

b) Changing the time on the clock

- Press the **+** and **- Buttons (6)** at the same time for a few seconds until the display flashes.
- Adjust the time indicated using the **+** and **- Buttons (6)**.
- Press the "PROGRAMMING" **Button (5)** to validate.

If the "PROGRAMMING" **Button (5)** is not pressed, the oven will automatically validate the numbers set after a few seconds.

Cooking straight away

The programmer should only be indicating the time; the figures should not be flashing.

• Select the cooking method

Turn the cooking selection knob to the position you require.

Example :  "CONVENTIONAL" position.

• Select the cooking temperature

Turn the temperature knob to the temperature recommended in your recipe.

Example : 200°C temperature mark.

The oven will then heat up and the temperature indicator will come on.

Nb : ALL COOKING IS DONE WITH THE OVEN DOOR CLOSED

After a cooking cycle, the cooling fan keeps working for some time to ensure the reliability of your oven.

THE LAYOUT OF THE CONTROL PANEL

Cooking using the programmer

Cooking for a specific length of time

- **Select the cooking method.**

Turn the cooking selection knob to the position you require

Example :  "CONVENTIONAL" position.

- **Select the cooking temperature.**

Turn the temperature knob to the temperature recommended in your recipe.

Example: 200°C temperature mark.

- **Select the cooking time.**

Press the "PROGRAMMING" **Button (5)**.

The cooking time (*indicating 0.00*) and the cooking time symbol flash to show that the time can be adjusted. The cooking time may be adjusted to any time up to 23 hours and 59 minutes.

Press the **+** and **- Buttons (6)** to adjust to the time you require.

Example: 30 minutes cooking time

The cooking time starts to count down as soon as the **+** and **- Buttons (6)** are released.

The cooking time symbol stops flashing and the time on the clock is displayed again. Cooking will then stop when the programmed cooking time is up.

Nb : You can:

- change the cooking time at any point by repeating the operations described above,
- check how much cooking time remains at any point by pressing the "PROGRAMMING" **Button (5)**
- cancel the programming at any point by pressing the "PROGRAMMING" **Button (5)** for a few seconds until you hear a beep.

At the end of the cooking time,

- the oven stops,
 - the cooking time symbol goes out,
 - the cooking time display indicates 0.00,
 - the oven beeps for a few minutes.
- Stop the beeping by pressing any button; the display shows the time on the clock again.

WARNING : your oven then starts to heat up again.

To stop the oven heating up, turn the temperature and function selection knobs to the "off" position.

THE LAYOUT OF THE CONTROL PANEL

Cooking for a specific length of time with a set time for the end of cooking

- Adjust the temperature and select the cooking method .

Example :  "CONVENTIONAL", position, 200°C temperature mark.

- Press the "PROGRAMMING" **Button (5)** once.

The cooking time (*indicating 0.00*) and the cooking time symbol flash to show that the time can be adjusted. The cooking time may be set to any time up to 23 hours and 59 minutes.

- Press the **+** and **- Buttons (6)** to adjust to the time you require.

Example: 25 minutes cooking time

Press once on **+**, to stop the flashing.

- Press the "PROGRAMMING" **Button (5)** until the time for the end of cooking and the corresponding symbol flash.

This may now be adjusted.

- Press the **+** and **- Buttons (6)** to adjust to the time you want cooking to end.

Example: cooking to end at 1 pm (13.00).

The time for cooking to end is registered automatically after a few seconds.

The display shows the time on the clock again.

The oven will then defer heating up so that the cooking time will end at the time programmed (eg 1 pm (13.00)).

When cooking starts, the "end of cooking" symbol goes out.

Nb: You can :

- change the cooking time at any point by repeating the operations described above,
- check how much cooking time remains at any point by pressing the "PROGRAMMING" **Button (5)**
- cancel the programming at any point by pressing the "PROGRAMMING" **Button (5)** for a few seconds until you hear a beep.

At the end of the cooking time,

- the oven stops,
- the cooking time symbol goes out,
- the cooking time display indicates 0.00
- the oven beeps for a few minutes.

Stop the beeping by pressing any button; the display shows the time on the clock again.

WARNING : your oven then starts to heat up again.

To stop the oven heating up, turn the temperature and function selection knobs to the "off" position.

Using the timer

Your oven is fitted with an electronic timer not dependent on the operation of the oven, for counting down a given time.

- Press the "PROGRAMMING" **Button (5)** a number of times until the timer symbol and the corresponding display flashes
- Set the time required by pressing on the **+** and **- Button (6)**. Adjustment is by blocks of 30 seconds; the time displayed is in minutes and seconds (from 0 to 59 mins. 30 secs.).

Keep pressing on the button to change the numbers more quickly.

The countdown will start a few seconds after the timer has been set; it remains visible at all times on the display.

Nb : It is possible to cancel the programming of the timer

When the time is up, the timer beeps (the display indicates 0.00).

Stop the beeping by pressing any button

ALL COOKING IS DONE WITH THE OVEN DOOR CLOSED, INCLUDING GRILLING.
 Your oven has runners which enable the following accessories to be positioned on three levels.

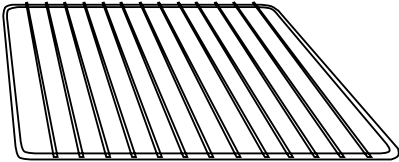

1 x shelf

This is used for holding all dishes and tins which contain food for cooking or browning.

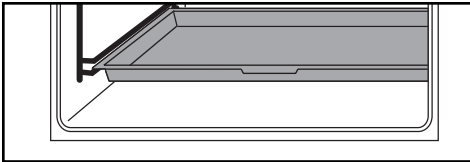

1 x Drip tray

Located under the grid, is used to collect greases from the roasted meat.
 Can also be filled with water to cook with steam ("bain-marie").
 Avoid placing meat on this tray as this will cause considerable splashing on the sides of the oven.

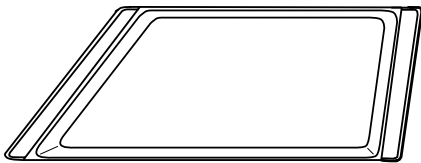

1 x flat baking tray

Placed directly on the shelf, this is used for cooking pastries, tarts, pizzas, etc...

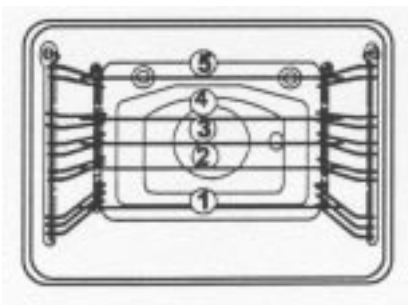

Oven Shelf Positions

C A R E A N D M A I N T E N A N C E

Before starting to clean your oven by hand, allow the appliance to cool down and check that the selector knob is at the 0 position.

General cleaning

- **Polished, painted or enamelled metal surfaces.**

Use commercial cleaning products designed for cleaning polished metal.

- **Oven door glass.**

When cooking has caused staining, you are strongly advised to clean the inner glass with a non-abrasive commercial cleaner. The metal cross-pieces on the oven door must not be cleaned with a scouring sponge or a harsh cleaning product.

- **Control knobs**

Clean the control knobs with soapy water.

- **Shelf and baking tray**

Use a sponge with a non-abrasive cleaner and never use sharp objects.

Changing the bulb

Warning: disconnect the appliance from the power supply before replacing the bulb.

- Turn the cover one quarter turn to the left.
- Unscrew the bulb and replace it with a heat-resistant (300 °C) bulb of the same size with an E14 base - 15 W.

F O R T H E I N S T A L L E R

As a specialist, you are the only person qualified to carry out the installation and connection of cooking appliances. For this reason, our guarantee applies solely and exclusively to appliances for which you have carried out the installation and connection in accordance with current regulations. Non-compliance with this condition will be the installer's responsibility and Kleenmaid will not be liable in any way.

Technical data	
Operating voltage	230 V ~ 50 Hz
Total electrical power consumption	2.535 kW
Power rating of grill	2.100 kW
Energy consumption	
- heating to 175 °C	0.36 kWh
- running for one hour at 175 °C	<u>0.74 kWh</u>
TOTAL	1.10 kWh
Usable dimensions of oven	
Width	42.5 cm
Height	33 cm
Depth	38.5 cm
Usable volume	54 litres

FIG 2

Building-in the oven (fig. 1)

The oven has an optimised air circulation system which enables the achievement of excellent cooking results and easy cleaning.

The total control of this air circulation system means that you should take note of the following:

- The oven may be installed with equal success under a worktop or in a column unit, as the hot air outlet is at the front.
- The fitting dimensions must be appropriate (see fig. 1).
- The material used for the housing unit must be heat resistant (or be covered with such a material).
- The distance between the oven and the sides of the unit, to the left and the right, must be the same so that it is correctly centred in relation to the doors of the neighbouring unit; **this distance must be at least 2 mm.** For greater stability, fix the oven into the unit using 2 screws in the holes provided in the lateral uprights (see fig.1).

Drill a 3 mm hole beforehand in the wall of the unit to prevent the wood splitting.

Connecting the oven

(Fig. 2)

- Before carrying out the connection, make sure that the cable from your mains supply have a sufficient rating to supply the appliance correctly.
- Electrical connection must be carried out before the appliance is fitted into the unit.
- The appliance must be connected to the power supply of 240V single phase, 20 AMP-circuit minimum. The earth wire (yellow/green) must be connected to the earth terminal on the appliance.
- Kleenmaid will not be liable in the event of an accident resulting from non-existent, faulty or incorrect earthing.
- The neutral supply must be connected to the neutral terminal on the terminal block.

CUT OUT DIMENSIONS

TO56X & TO56W

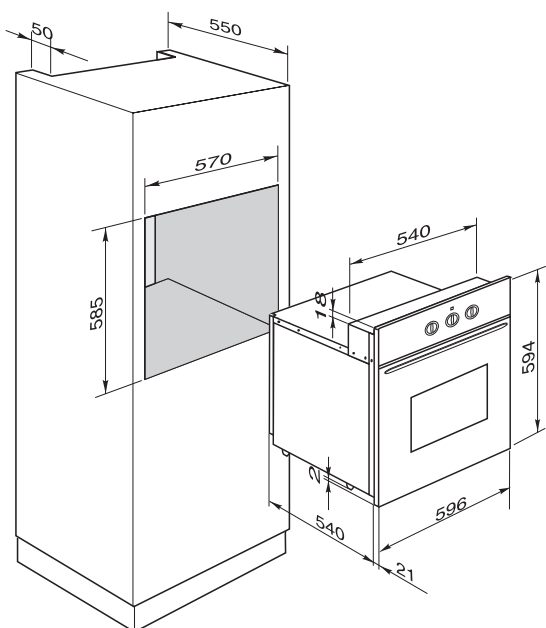

The illustration above shows the TO56 'Proud' mounted

FIG 1

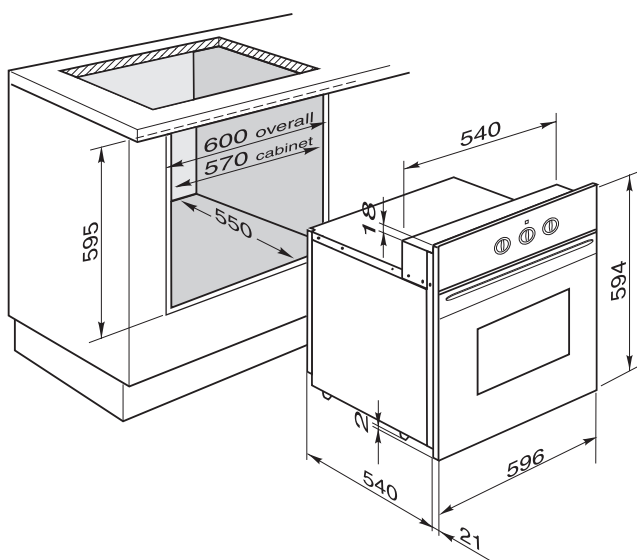

The illustration above shows the TO56 'Flush' mounted

This built-in cooker meets the requirements of heat protection according to the Australian standard.

Appliance dimensions and cavity measurements (in mm)

For safety purposes, one has to keep strictly to the cavity measurements. Fit the appliance into the kitchen unit using the 4 screws supplied.

Your oven has maximised air circulation which gives remarkable cooking and cleaning properties on condition that the following indications are followed:

- The oven can be either installed on a working surface or in a cupboard suitably sized, at eye level (see drawing).
- Centre the oven in the cupboard so as to leave a margin of 2mm from the adjacent cupboards.
- Cupboard material must be heat-resistant (or be covered with similar material).
- For greater stability, fix the oven in a cupboard with four screws in the holes provided for this purpose on the sides. Make a \varnothing 3mm hole beforehand in the cupboard wall to avoid the wood splitting.

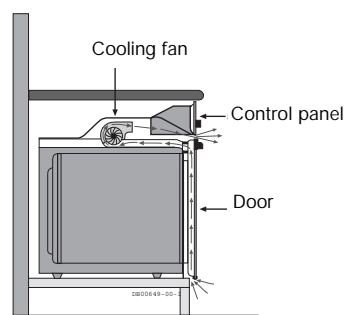

Note - It is advisable to have this equipment installed by a specialist fitter.

Model	Capacity	Approval No	Installation Method	Dimensions			Electrical Ratings
TO56	54 litres	Q01272	Flush	594(H)	596(W)	561(D)	240V-50Hz
			Proud	594(H)	596(W)	561(D)	2.53kW

ADVICE ON USING THE OVEN

Cooking meat

- 1 - If your meat is cooked through without being browned on the outside:
 - Try using the fan assisted grill or grill function instead.
 - Place the meat closer to the grill
 - Do not pre-heat when using the fan assisted grill function.
 - Increase the temperature setting.
- 2 - If your meat is too brown on the outside but undercooked in the centre:
 - Try using the conventional function instead.
 - Move the meat further away from the grill when using the fan assisted grill or grill functions.
 - Pre-heat for less time.
 - Lower the temperature setting.
- 3 - If your oven is very dirty you have cooked at too high a temperature:
 - Lower the temperature setting.
 - Do not use the dripping pan with the conventional function.
- 4 - If you use the dripping pan and the shelf:
 - Add a small amount of liquid to the dripping pan to prevent the fat which runs off the meat from burning.

Successful baking

- 1 - If the top of the cake is a dark colour and the bottom is a very light colour, you have not cooked with enough heat from below:
 - Move the cake lower down the oven.
 - Use a dark-coloured tin.
 - Lower the temperature setting.
- 2 - If the top of the cake is a light colour and the bottom is dark, you have cooked with too much heat from below:
 - Place the cake higher up the oven.
 - Use a light-coloured tin.
 - Lower the temperature setting.
- 3 - If the outside is overdone, while the inside is undercooked or it is unevenly browned, you are cooking at too high a temperature:
 - Lower the temperature setting.
 - Increase the cooking time.
- 4 - If the outside is too dry but is a good colour, you have cooked it for too long and at too low a temperature:
 - Reduce the cooking time.
 - Increase the temperature setting.

Multiple cooking = Fan forced oven

It is possible to cook several dishes (the same or different types) simultaneously, without flavour or odour being passed from one to the other, as long as you choose dishes cooked at the same temperature. (They do not have to be placed in the oven or taken out at the same time).

Depending on the number of levels used, you may have to purchase additional equipment.























Note: The cooking guide gives the cooking time for a single dish. When cooking several dishes increase this time by 10 to 20 minutes.

Additional information

Tins made of black metal with a non-stick interior and gilded metal tins are the most suitable because they absorb heat rapidly and transmit it to the dough. This means that cooking time is reduced and less energy is required. Baking utensils made of tin reflect the heat, which means they reject it. Cakes and pies baked in these tins will not brown properly and take longer to cook. This type of utensil is not recommended for baking in a convection oven. With respect to the temperatures given in recipe books for conventional cooking, when cooking dishes using the fan-assisted settings, the temperature should be reduced by 10 to 25°C for baking and by 20 to 40°C for meat. The cooking time should then be decreased slightly.

SUGGESTED COOKING GUIDE

Conversion mark										°C
Mark °C	1 50°C	2 70°C	3 90°C	4 120°C	5 150°C	6 180°C	7 210°C	8 240°C	9 270°C	MAXI 275°C

DISHES	COOK FUNCTION SELECTOR	SUGGESTED TEMPERATURE	SHELF POSITION	ACCESSORIES	TIME	NOTES
STARTERS VEGETABLES						
<i>Pizza</i>		Fan assisted 205°C	2nd	Deep baking tray	18 -20 min.	Depending on thickness
<i>Quiche lorraine</i> *		Fan assisted 205°C	1st	Tin on shelf	30-35 min.	28 cm tin
<i>Cheese soufflé</i>		Fan forced 180°C	1st	Tin on shelf	35 min.	
<i>Potato bake</i>		Fan forced 180°C	1st	Dish on shelf	45-50 min.	Depending on quantity - Lower heat after 30
<i>Stuffed tomatoes</i>		Fan forced 180°C	1st	Dish on shelf	40-45 min.	
<i>Provencal tomatoes</i>		Fan assisted grilling 230°C	2nd	Dish on shelf	20 min.	
FISH						
<i>Sea bream</i>		Fan forced 180°C	1st	Dish on shelf	25-30 min.	Depending on thickness
<i>Mackerel</i> *		Grill 275°C	3rd	Placed on shelf	6-7 min. a side	Dripping pan on 1st shelf position
MEAT						
<i>Lamb chops</i> *		Grill 275°C	3rd	Meat on shelf	5-6 min. a side	Dripping pan on 1st shelf position
<i>Leg of lamb</i>		Fan forced 190°C	2nd	Meat on shelf	15-20 min./500g	Dripping pan on first shelf position
<i>Roast beef</i>		Fan forced 235° or 220°C	1st	Dish on shelf	10-15 min./500g	During cooking pre-heat the oven
<i>Roast pork/veal</i>		Fan assisted 180°/200°C	1st	Dish on shelf	35-40 min./500g	
<i>Chicken</i>		Fan assisted 180°/200°C	1st	Dish on shelf	25 min./500g	
<i>Guinea fowl/rabbit</i>		Fan assisted 180°/200°C	1st	Dish on shelf	20-25 min./500g	
BAKING						
<i>Brioche</i>		Fan assisted 160°C	1st	Tin on shelf	35 min.	
<i>Fruit cake - Pound cake</i>		Fan assisted 170°C	1st	Tin on shelf	45-50 min.	
<i>Shortbread</i>		Fan forced 165°C	2nd	Deep baking tray	15-18 min.	
<i>Apple pie</i>		Fan assisted 160°C	1st	Tin on shelf	60 min.	
<i>Soft fruit tart</i>		Fan assisted 205°C	1st	Tin on shelf	35-40 min.	28 cm diameter tin
<i>Apple tart</i>		Fan forced 205°C	1st	Tin on shelf	35-40 min.	28 cm diameter tin
<i>Puff pastry</i> *		Conventional 225°C	2nd	Deep baking tray	15 min.	Pastry without filling
<i>Choux pastry</i> *		Conventional 200°C	2nd	Deep baking tray	30 min.	
<i>Egg custard</i>		Conventional 160°C	2nd	Deep baking tray	20 min.	6 ramekins in a bain-marie

* These dishes are best placed in a hot oven.

Cooking should always be done with the door closed.

WARRANTY AND SERVICE

Domestic Warranty - Full Five Year Warranty

In addition to all statutory rights which you, the Consumer, have under all the relevant laws in respect to this appliance, during your first five years of ownership as the purchaser of this Kleenmaid Appliance, we guarantee that any fault caused by faulty material or workmanship becoming apparent will be rectified free of charge for parts and labour provided that all service is performed during normal working hours by Kleenmaid or their designated Agents. Where the Appliance is installed outside the normal servicing area of the above, the Purchaser must pay the cost of transporting the Appliance to and from the Agent or the Agent's travelling cost to and from the Purchaser's home.

Commercial Warranty - One Year Warranty

In addition to all statutory rights which you, the Consumer, have under all the relevant laws in respect to this appliance, during your first one year of ownership as the purchaser of this Kleenmaid Appliance, we guarantee that any fault caused by faulty material or workmanship becoming apparent will be rectified free of charge for parts and labour provided that all service is performed during normal working hours by Kleenmaid or their designated Agents. Where the Appliance is installed outside the normal servicing area of the above, the Purchaser must pay the cost of transporting the Appliance to and from the Agent or the Agent's travelling cost to and from the Purchaser's home.

What This Warranty Does Not Cover

We are not responsible for any damage or malfunction unless by a defect in material or workmanship. This includes but is not limited to abuse, misuse, improper installation and transportation damage. We are not responsible for any consequential damages resulting from any malfunction.

This Warranty does not cover replacement of light bulbs or glass breakage due to impact.

In case of fractured glass do not use your appliance

Warranty Registration

Please complete the enclosed warranty card and retain it together with your proof of purchase document. These documents will need to be viewed by our Service Representative should you request in warranty service.

Service Assistance

To assist you when phoning our After Sales Service number to arrange a service call, please complete the following and have these details ready.

Model No.*.....

Kleenmaid Store purchased from.....

Date of purchase...../...../..... Date of Installation...../...../.....

KLEENMAID AFTER SALES SERVICE

1300 652 100

* The Model No is shown on the underside of the control panel.

Other products in Kleenmaid's
range of world's best appliances:

Washers

Dryers

Dishwashers

Ovens

Cooktops

Rangehoods

Sinks

Waste disposals

Taps

Cookware

Refrigerators

Freezers

Vacuum Cleaners

For sales information on the full range of quality
kitchen and laundry appliances, phone **13 13 08**.

Kleenmaid Head Offices:
PO Box 5560 MAROOCHYDORE BC QLD 4558